

Specification Sheet

Part Number: 151-01659

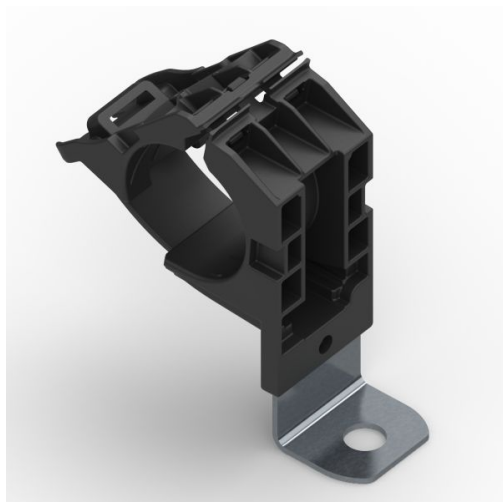

Article Number

151-01659

Type

RCC90SM6

Color

Black (BK)

Features & Benefits

- One-piece ratchet closure design allows for easy installation during pre- or final assembly.
- Four sizes and multiple configurations handle a wide range of diameters and applications, reducing part inventory.
- Clamp interior is designed to guide and center bundle to reduce pinching.
- Easy release feature allows for quick adjustments and maintenance.
- Impact modified, heat and UV stabilized PA66 provides long-term durability, indoors and out.
- Steel mounting plate tolerates high torque mounting and is treated to resist chemicals and salt spray.

Quantity Per

carton

Product Description

The Ratchet P-Clamp family offers versatility when managing wires, cables and hoses. The robust design and durable materials make it ideal for heavy duty applications, both indoors and out. The one-piece adjustable clamp can be closed by hand to the desired diameter. The release feature provides easy and nondestructive removal of cables simply by using a flat-head screwdriver. This nondestructive release allows the clamp to be reused without removing or replacing any bolts or screws. The Ratchet P-Clamp is offered in four sizes and multiple mounting configurations.

Short Description

Ratchet P-Clamp, .76"–1.42" Bundle Dia, 90° Short, .26" Hole Dia, PA66HIRHSUV/ST/ZN, Black, 160/ctn

Global Part Name

RCC90SM6-PA66HIRHSUV/ST/ZN-BK

Minimum Tensile Strength (Imperial)

100.0

Minimum Tensile Strength (Metric)

445.0

Length L (Imperial)

5.58

Length L (Metric)

141.8

Fixation Method

Screw Mounting

Variant

Short

Width W (Imperial)

1.37

Width W (Metric)

34.9

Bundle Diameter Min (Imperial)

0.76

Bundle Diameter Min (Metric)

19.4

Bundle Diameter Max (Imperial)

1.42

Bundle Diameter Max (Metric)	36.0
Cable Tie Width Max (Imperial)	0.52
Cable Tie Width Max (Metric)	13.2
Mounting Hole Diameter D (Imperial)	0.256
Mounting Hole Diameter D (Metric)	6.5 mm
Mounting Hole Diameter D Max (Metric)	6.5
Stud Diameter (Metric)	M6
Mounting Hole Centers (Imperial)	1.57
Material	Polyamide 6.6 high impact modified, heat and UV stabilized (PA66HIRHSUV) Zinc plated (ZN) Steel (ST)
Material Shortcut	ZN ST PA66HIRHSUV
Flammability	UL 94 HB
UV Resistant (Yes/No)	Yes
Operating Temperature (Metric)	-40°F to +257°F (-40°C to +125°C)
Reach Complaint(Article 33)	Yes
ROHS Complaint	Yes

UL Recognized (US) Yes

UL Listed (US and Canada) Yes

UL Recognized (US and Canada) Yes

Package Quantity(Imperial) 160

Package Quantity (Metric) 160

Customs Number 3926909987

Content Unit(BMEcat) pcs.