

2-966067-2 ✓ ACTIVE

TE Internal #: 2-966067-2

Ferrule, 10 AWG Wire Size, 5 – 6 mm<sup>2</sup> Wire Size, 10382 CMA Wire Size, 6.3 mm [.25 in] Barrel Inside Diameter, Closed, Tin Plating

[View on TE.com >](#)



Terminals & Splices > Crimp Wire Pins, Tabs & Ferrules

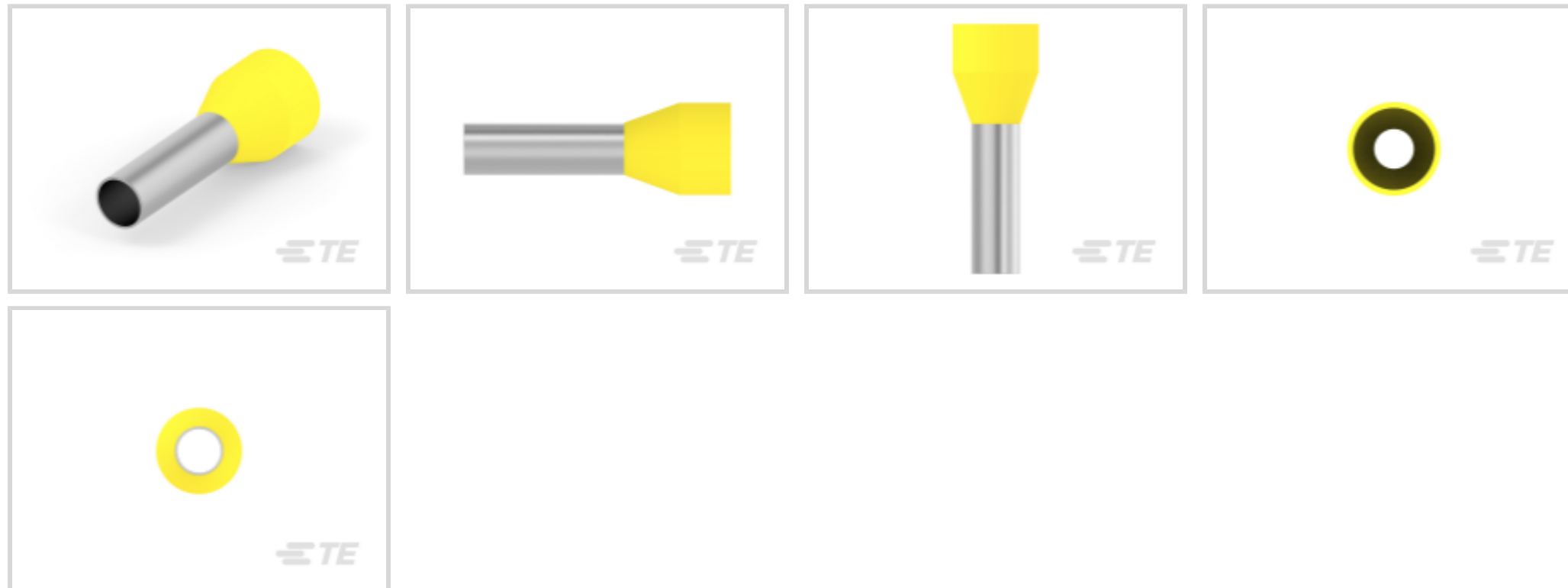

Crimp Wire Terminal Type: **Ferrule**

Compatible Insulation Diameter Range: **6.2 mm [ .244 in ]**

Wire Size: **10382 CMA**

## Features

### Body Features

Primary Product Color	Yellow
-----------------------	--------

### Product Type Features

Sealable	No
Compatible With Discrete Wire Type	Stranded

### Packaging Features

Packaging Quantity	100
Packaging Method	Bag

### Dimensions

Strip Length	14 mm[.551 in]
2-Wire Size	10 AWG
Compatible Insulation Diameter Range	6.2 mm[.244 in]
Wire Size	10382 CMA
Barrel Inside Diameter	6.3 mm[.25 in]
Terminal Material Thickness	.2 mm[.007 in]
Overall Product Length	20 mm[.787 in]

### Contact Features

--	--



Contact Mating Area Length	12 mm[.468 in]
Crimp Wire Terminal Type	Ferrule
Barrel Type	Closed
Terminal Plating Material	Tin
Terminal Orientation	Straight

### Configuration Features

Compatible With Wire & Cable Type	Discrete Wire
-----------------------------------	---------------

### Mechanical Attachment

Wire Insulation Support	Without
-------------------------	---------

### Usage Conditions

Insulation Option	Partially Insulated
Operating Temperature Range	105 °C[221 °F]

### Other

EU RoHS Compliance	Compliant
EU ELV Compliance	Compliant

## Product Compliance

[For compliance documentation, visit the product page on TE.com>](#)

EU RoHS Directive 2011/65/EU	Compliant
EU ELV Directive 2000/53/EC	Compliant
China RoHS 2 Directive MIIT Order No 32, 2016	No Restricted Materials Above Threshold
EU REACH Regulation (EC) No. 1907/2006	Current ECHA Candidate List: JUNE 2024 (241) Candidate List Declared Against: JUNE 2024 (241) Does not contain REACH SVHC
Halogen Content	Low Halogen - Br, Cl, F, I < 900 ppm per homogenous material. Also BFR/CFR/PVC Free
Solder Process Capability	Not applicable for solder process capability

#### Product Compliance Disclaimer

This information is provided based on reasonable inquiry of our suppliers and represents our current actual knowledge based on the information they provided. This information is subject to change. The part numbers that TE has identified as EU RoHS compliant have a maximum concentration of 0.1% by weight in homogenous materials for lead, hexavalent chromium, mercury, PBB, PBDE, DBP, BBP, DEHP, DIBP, and 0.01% for cadmium, or qualify for an exemption to these limits as defined in the Annexes of Directive 2011/65/EU (RoHS2). Finished electrical and electronic equipment products will be CE marked as required by Directive 2011/65/EU. Components may not be CE marked. Additionally, the part

numbers that TE has identified as EU ELV compliant have a maximum concentration of 0.1% by weight in homogenous materials for lead, hexavalent chromium, and mercury, and 0.01% for cadmium, or qualify for an exemption to these limits as defined in the Annexes of Directive 2000/53/EC (ELV). Regarding the REACH Regulation, the information TE provides on SVHC in articles for this part number is based on the latest European Chemicals Agency (ECHA) 'Guidance on requirements for substances in articles' posted at this URL: <https://echa.europa.eu/guidance-documents/guidance-on-reach>

## Compatible Parts



TE Part # 539660-1  
ADERENDHUELSEN (Ferrule) Crimp Tool

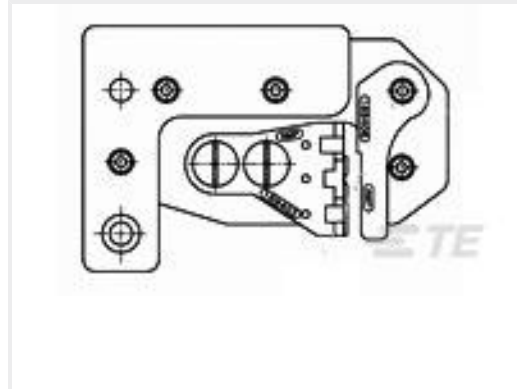

TE Part # 2-1579001-3  
CSE10-AE22 CRIMP HEAD

## Customers Also Bought



TE Part #770849-7  
07P SL156 HSG W/LCK RMP & TABS

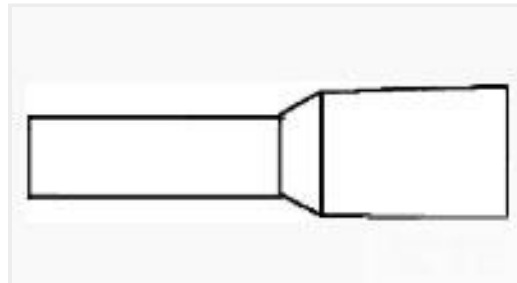

TE Part #2-966067-0  
FER,WIRE,PL SLV,4.00/12,L12,GREY,LP

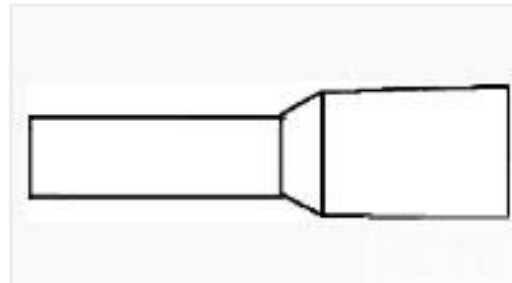

TE Part #1-966067-6  
FER,WIRE,PL SLV,2.50/14,L8,BLUE,LP

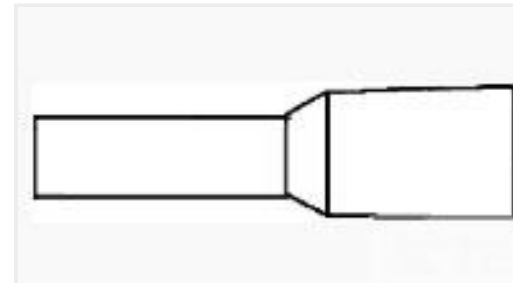

TE Part #966067-9  
FER,WIRE,PL SLV,1.00/18,L8,RED,LP

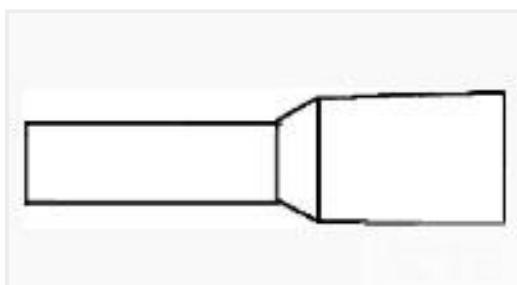

TE Part #966067-5  
FER,WIRE,PL SLV,.75/18,L8,GREY,LP

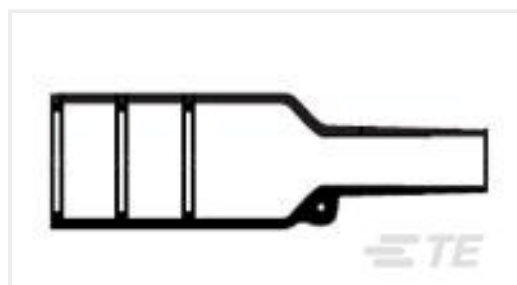

TE Part #675477-000  
202K142-25-01/225-0

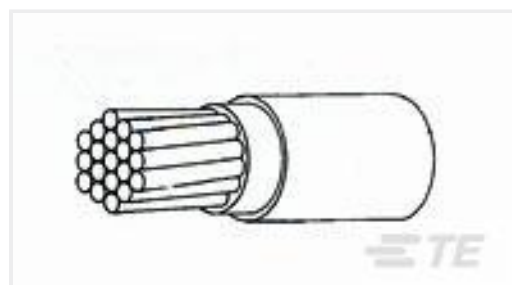

TE Part #6014873001  
VG-95218-T020-A006

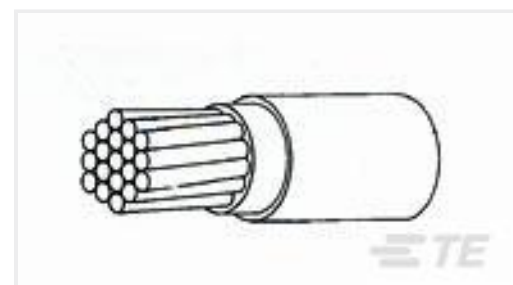

TE Part #9931953001  
VG-95218-T020-A003



TE Part #3008293001  
VG-95218-T022-C003



TE Part #2590393001  
VG-95218-T023-F005

## Documents

### Product Drawings



**FER,WIRE,PL SLV,6.00/10,L12,YELLOW,LP**

English

**CAD Files**

**3D PDF**

English

**Customer View Model**

[ENG\\_CVM\\_2-966067-2\\_B1.2d\\_dxf.zip](#)

English

**Customer View Model**

[ENG\\_CVM\\_2-966067-2\\_B1.3d\\_igs.zip](#)

English

**Customer View Model**

[ENG\\_CVM\\_2-966067-2\\_B1.3d\\_stp.zip](#)

English

**Customer View Model**

[ENG\\_CVM\\_CVM\\_2-966067-2\\_B1.2d\\_dxf.zip](#)

English

**Customer View Model**

[ENG\\_CVM\\_CVM\\_2-966067-2\\_B1.3d\\_stp.zip](#)

English

**3D PDF**

3D

**Customer View Model**

[ENG\\_CVM\\_CVM\\_2-966067-2\\_B1.3d\\_igs.zip](#)

English

By downloading the CAD file I accept and agree to the [Terms and Conditions](#) of use.

**Datasheets & Catalog Pages**

**BUCHANAN TERMINAL BLOCKS CATALOG - EUROSTYLE TERMINAL BLOCKS**

English

**Wire Ferrules**

English

**WIRE END FERRULES**

English

**Agency Approvals**

**CSA Certificate**

English