

4

3

2

1

| REVISIONS | | | | |
|-----------|-----|-------------|------|----------|
| ZONE | REV | DESCRIPTION | DATE | APPROVED |
| | | | | |

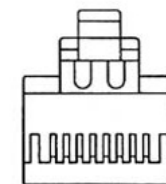
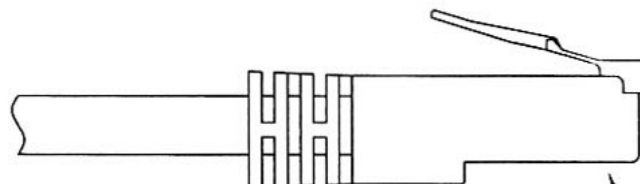
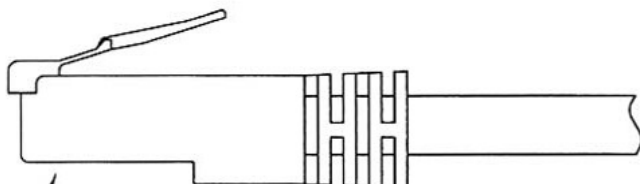
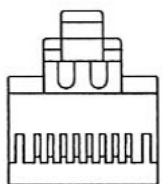

PIN : DC-568P- (XX) (LL)
(MOLDED)

(XX) : AVAILABLE LENGTH (FT.) : 1, 2, 3, 4, 5, 6, 7, 10, 15, 25, 50, 75, 100

(LL) : AVAILABLE COLOR : BL (BLUE), RD (RED)

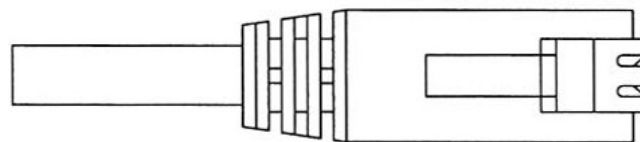
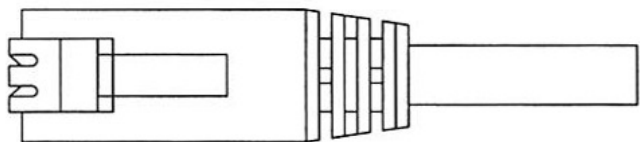

REVISE PER
ACTUAL PRODUCT

PAIR WIRING

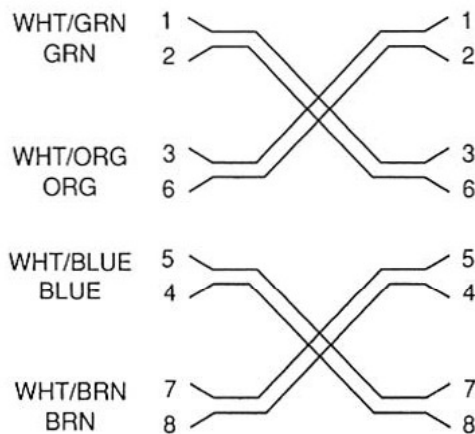

PLUGS : 8P8C, RJ-45, 50 μ " GOLD PLATED CONTACTS
SEE XXX-XX FOR DETAIL, PAN PARTS # PT-0688/50UL
ALL PLUGS CABLES ARE BLUE OR RED JACKET
WITH YELLOW MOLDED ENDS

| | | | |
|----------|-----------|---------------------|---------|
| BY | DATE | | PART NO |
| DRAWN JX | 06/28/01 | | |
| CHK'D | | DC-568P-(LL) (CC) H | |
| APPRV | | | |
| MATERIAL | SEE NOTES | UNITS | mm |
| FINISH | SEE NOTES | SCALE | NONE |
| | | SHEET 1 OF 1 | |

4

3

2

1