

DCS.F2.N02.PA Instruction Manual

The DCS.F2.N02.PA is a high-performance device designed for cleaning the ferrule end faces of LEMO's fiber optic F2 contacts. Carefully read this instruction manual before using this device. Please keep this instruction manual for future reference.

For use with LEMO F2 contacts such as:

FFS.F2.BA2.LCE30 (male contact)

PSS.F2.BA2.LCE30 (female contact)

FFT.F2.BA2.LCE10 (male contact field terminated)

FFS.F2.BA2.LCT10 (male contact)

PSS.F2.BA2.LCT10 (female contact)

PST.F2.BA2.LCE10 (female contact field terminated)

These contact types are commonly used in the 3K.93C Series broadcast connectors (SMPTE connectors).

1. Safety precautions

Though our device is deemed safe, improper usage or handling can still inflict injury to others.

The DCS.F2.N02.PA is designed to clean ANSI/SMPTE (304 M-1009 and 311M-1998) based connectors, or other LEMO connectors with F2 contacts.

LEMO is not liable for damage caused in attempt to apply this device to other applications.

2. Notes on usage

Do not attempt to disassemble as this can cause damage to the device.

Do not re-use cleaning cloth as this will eliminate its cleaning ability.

Do not touch the cleaning cloth as this will cause contamination.

Do not pull the cleaning cloth, use only the device body.

Do not use this cleaner when the cloth is empty, as this can cause damage to the connector.

3. Notes on storage for extended periods

Do not expose device to direct sunlight, high temperature or high humidity.

The cover on the guide cap should be closed at all times when device is not in use.

4. Device construction

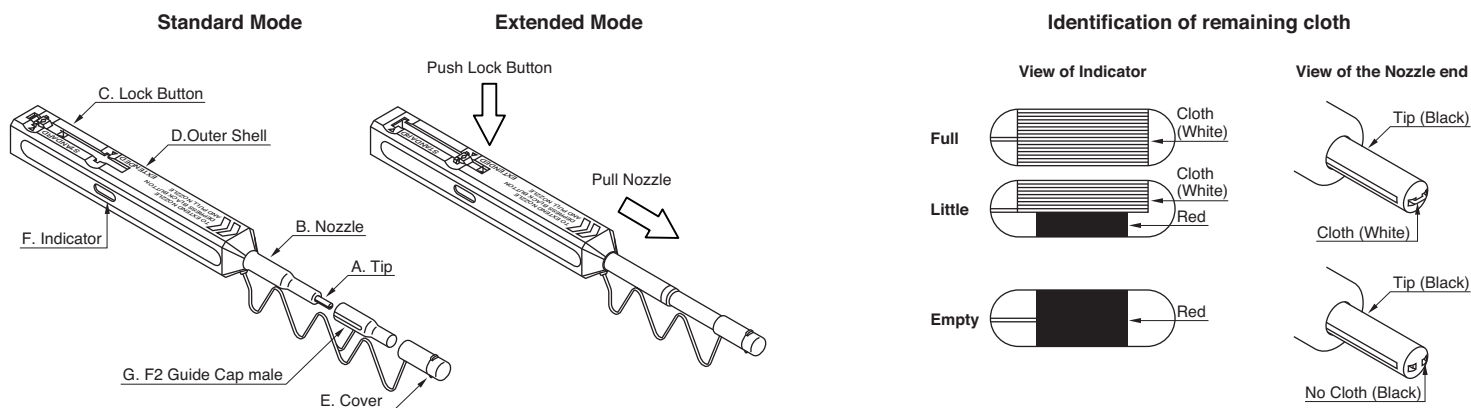

No	Part Name	Function
A	Tip	Lead the cleaning cloth to the optical connector end face
B	Nozzle	Lead tip to the optical connector end face
C	Lock Button	Push the button to extend and contract the nozzle
D	Outer Shell	Push the outer shell to clean the connector
E	Cover	Avoids contamination of tip
F	Indicator	Provides indication of remaining cleaning cloth
G	F2 Guide Cap male	For use with F2 male contact

6. Applications

Female F2 contact cleaning

1. Remove Guide Cap and cover from the device.

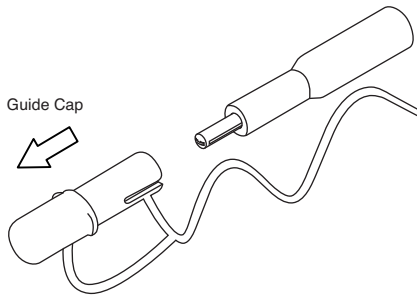

2. Insert tip of cleaner into sleeve of the connector

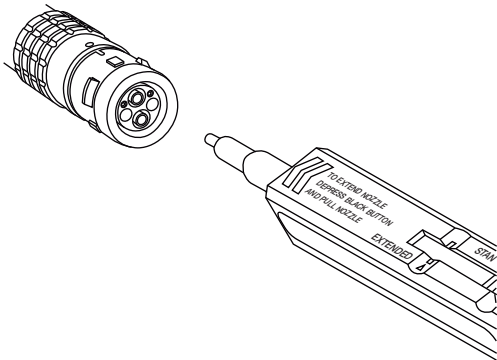

3. Push the Outer Shell to start cleaning the F2 contact. A "click" sound indicates end of cleaning process. Close the cover after use.

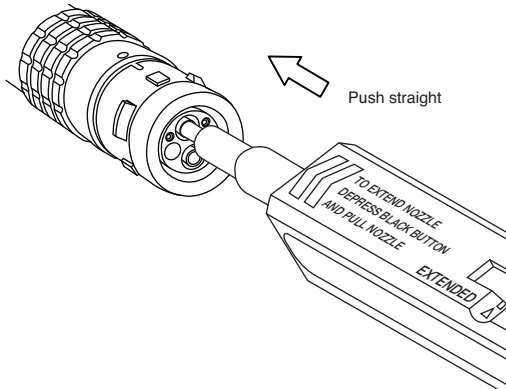

Be careful not to slant the DCS.F2.N02.PA while inserting into the adapter. Do not overly exert force during insertion as this may cause damage to both the connector and the DCS.F2.N02.PA Cleaner. If pushing Outer Shell is inhibited, remove DCS.F2.N02.PA from adapter and ensure that there is no sizeable debris inhibiting the cleaning process.

Male F2 contact cleaning

1. Open the Cover on the Guide Cap.

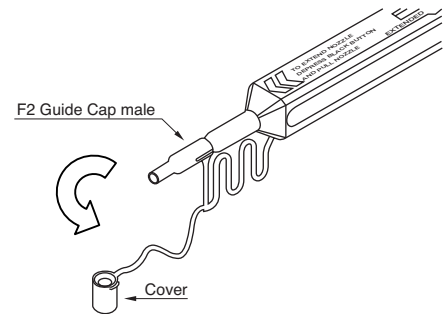

2. Insert tip of cleaner into sleeve of the connector with the F2 Guide Cap on.

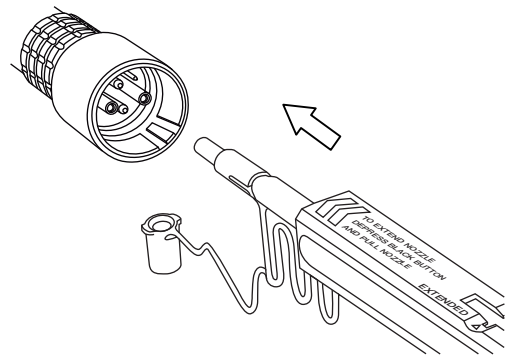

3. Push the Outer Shell to start cleaning the F2 contact. A "click" sound indicates end of cleaning process. Close the cover after use.

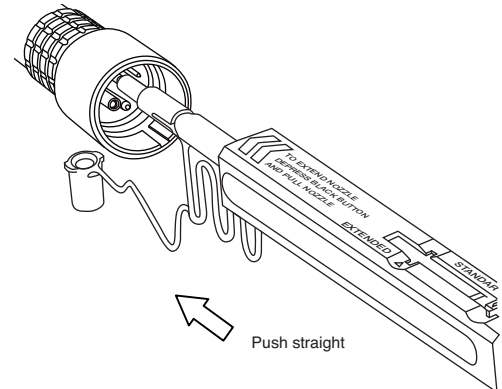

Be careful not to slant connector while inserting into the F2 Guide cap. Do not overly exert force during insertion as this may cause damage to both the connector and the DCS.F2.N02.PA Cleaner. If pushing Outer Shell is inhibited, remove DCS.F2.N02.PA from adapter and ensure that there is no sizeable debris inhibiting the cleaning process.

LEMO USA Inc.

Tel : 707-578-8811 Fax : 707-578-0869 Toll Free : 800-444-5366

E-mail : info@lemousa.com <http://www.lemo.com>