



GDM Series Valve Connectors, Type A, Overmolded Female Connectors

Technical Information

Product Description	
Order Designation	GANXX0U-AOU GANXXLU-AOU
	 
Description	Valve connector GDM series, type A, female connector overmolded, with UL approval, available with different pin options
RoHS-Compliant (2011/65/EU)	Yes
(Construction Type) Standard	DIN EN 175301-803-A
Approvals	VDE, UL
Technical Data	
No. of Pins	2, 2 + PE, 2 + 2PE, 3 + PE
Ambient Temperature	-25 °C to +85 °C (UL), -40 °C/+105 °C (with additional gasket)
Housing/Grip/Screw Coupling	TPU, black (UL) TPU, gray translucent
Contact Holder	PA 66
Contact	CuZn
Central Screw	4.8, Fe/Zn B
Flammability Class	HB
Mechanical Data	
Degree of Protection	IP67, IP68/IP69K with PUR cable (only when mated with Hirschmann/Lumberg counterparts)
Electrical Data	
Circuit	No protection circuit
Rated Voltage	Up to 250 V AC/DC (max. 50 V AC/DC without PE)
Rated Current	10 A (cable: 0.75 mm ²), 6 A (cable: 0.5 mm ²)
Pollution Degree	3
Accessories	
Cable	PVC, PUR
Conductor Size	2 x 0.75 mm ² , 3 x 0.50 mm ² , 3 x 0.75 mm ² , 4 x 0.50 mm ² , 4 x 0.75 mm ²
Scope of Delivery or Accessories (incl.)	Central screw
Accessories to be Ordered Separately	735633002, GAN gasket 735656002, fixing clip for additional gasket

Technical Drawing

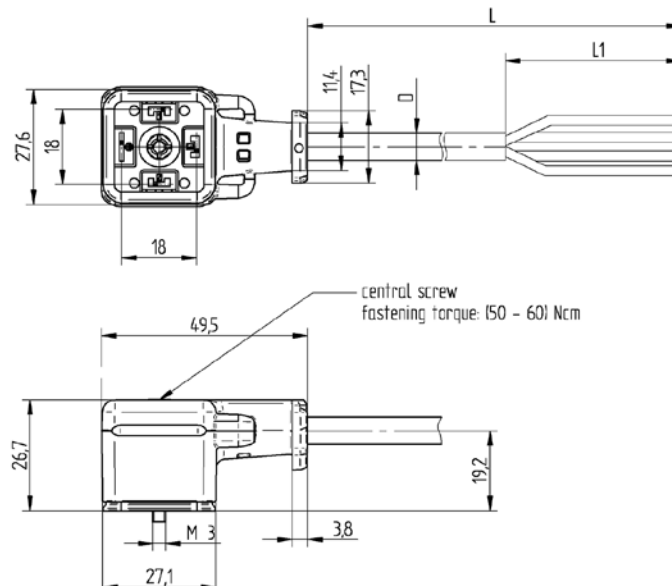

Be Certain with Belden

Pin Assignment

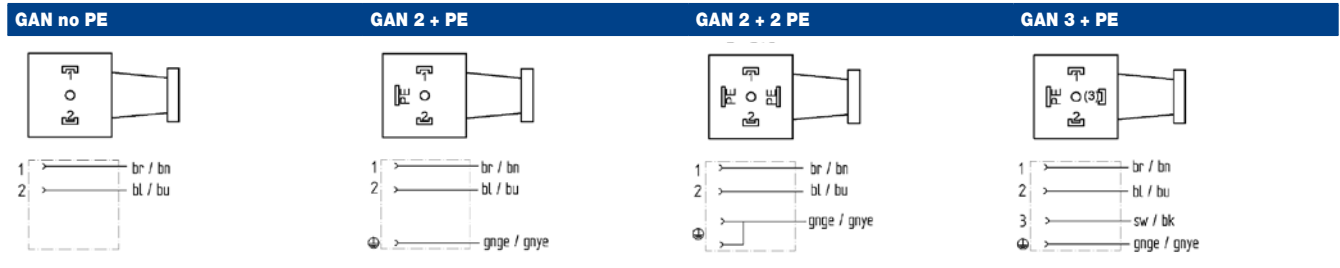

Circuit Diagram

P-Code: A0U

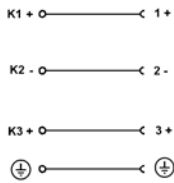









Order Information

Order No.	Order Designation	No. of Pins	Cable Length	Rated Voltage	Conductor Size	Jacket	Characteristics
934889087	GAN20LU-A0U-6060200	2	2 M	50 V/universal, without LED	2 x 0.75 mm ²	PUR, gray	
934889088	GAN20LU-A0U-6060500	2	5 M	50 V/universal, without LED	2 x 0.75 mm ²	PUR, gray	
6736	GAN20LU-A0U-6061000	2	10 M	50 V/universal, without LED	2 x 0.75 mm ²	PUR, gray	
934889085	GAN20LU-A0U-6120200	2	2 M	50 V/universal, without LED	2 x 0.75 mm ²	PVC, gray	
934889086	GAN20LU-A0U-6120500	2	5 M	50 V/universal, without LED	2 x 0.75 mm ²	PVC, gray	
10547	GAN20LU-A0U-6121000	2	10 M	50 V/universal, without LED	2 x 0.75 mm ²	PVC, gray	
934889073	GAN21LU-A0U-6030200	2 + PE	2 M	250 V/universal, without LED	3 x 0.75 mm ²	PUR, gray	
934889074	GAN21LU-A0U-6030500	2 + PE	5 M	250 V/universal, without LED	3 x 0.75 mm ²	PUR, gray	
10548	GAN21LU-A0U-6031000	2 + PE	10 M	250 V/universal, without LED	3 x 0.75 mm ²	PUR, gray	
934889083	GAN22LU-A0U-6030200	2 + 2 PE	2 M	250 V/universal, without LED	3 x 0.75 mm ²	PUR, gray	
934889084	GAN22LU-A0U-6030500	2 + 2 PE	5 M	250 V/universal, without LED	3 x 0.75 mm ²	PUR, gray	
10903	GAN22LU-A0U-6031000	2 + 2 PE	10 M	250 V/universal, without LED	3 x 0.75 mm ²	PUR, gray	
934889070	GAN21LU-A0U-6090200	2 + PE	2 M	250 V/universal, without LED	3 x 0.75 mm ²	PVC, gray	
934889071	GAN21LU-A0U-6090500	2 + PE	5 M	250 V/universal, without LED	3 x 0.75 mm ²	PVC, gray	
934889072	GAN21LU-A0U-6091000	2 + PE	10 M	250 V/universal, without LED	3 x 0.75 mm ²	PVC, gray	

Conversion table mm² to AWG on page 22.

GDM Series Valve Connectors, Type A, Overmolded Female Connectors (continued)



Order Information

Order No.	Order Designation	No. of Pins	Cable Length	Rated Voltage	Conductor Size	Jacket	Characteristics
934889001	GAN22LU-A0U-2050200	2 + 2 PE	2 M	250 V/universal, without LED	3 x 0.75 mm ²	PVC, black	   
934889002	GAN22LU-A0U-2050500	2 + 2 PE	5 M	250 V/universal, without LED	3 x 0.75 mm ²	PVC, black	   
934889003	GAN22LU-A0U-2051000	2 + 2 PE	10 M	250 V/universal, without LED	3 x 0.75 mm ²	PVC, black	   
10904	GAN22LU-A0U-2260200	2 + 2 PE	2 M	250 V/universal, without LED	3 x 0.50 mm ²	PUR, black	   
934889004	GAN22LU-A0U-2260500	2 + 2 PE	5 M	250 V/universal, without LED	3 x 0.50 mm ²	PUR, black	   
934889005	GAN22LU-A0U-2261000	2 + 2 PE	10 M	250 V/universal, without LED	3 x 0.50 mm ²	PUR, black	   
934889081	GAN22LU-A0U-6090200	2 + 2 PE	2 M	250 V/universal, without LED	3 x 0.75 mm ²	PVC, gray	   
934889082	GAN22LU-A0U-6090500	2 + 2 PE	5 M	250 V/universal, without LED	3 x 0.75 mm ²	PVC, gray	   
934889129	GAN22LU-A0U-6091000	2 + 2 PE	10 M	250 V/universal, without LED	3 x 0.75 mm ²	PVC, gray	   
934889006	GAN31LU-A0U-7430200	3 + PE	2 M	250 V/universal, without LED	4 x 0.50 mm ²	PVC, black	   
934889007	GAN31LU-A0U-7430500	3 + PE	5 M	250 V/universal, without LED	4 x 0.50 mm ²	PVC, black	   
934889008	GAN31LU-A0U-7431000	3 + PE	10 M	250 V/universal, without LED	4 x 0.50 mm ²	PVC, black	   
934889009	GAN31LU-A0U-7440200	3 + PE	2 M	250 V/universal, without LED	4 x 0.50 mm ²	PUR, black	   
934889010	GAN31LU-A0U-7440500	3 + PE	5 M	250 V/universal, without LED	4 x 0.50 mm ²	PUR, black	   
934889011	GAN31LU-A0U-7441000	3 + PE	10 M	250 V/universal, without LED	4 x 0.50 mm ²	PUR, black	   
934889078	GAN31LU-A0U-6040200	3 + PE	2 M	250 V/universal, without LED	4 x 0.75 mm ²	PUR, gray	   
934889079	GAN31LU-A0U-6040500	3 + PE	5 M	250 V/universal, without LED	4 x 0.75 mm ²	PUR, gray	   
7947	GAN31LU-A0U-6041000	3 + PE	10 M	250 V/universal, without LED	4 x 0.75 mm ²	PUR, gray	   
934889075	GAN31LU-A0U-6100200	3 + PE	2 M	250 V/universal, without LED	4 x 0.75 mm ²	PVC, gray	   
934889076	GAN31LU-A0U-6100500	3 + PE	5 M	250 V/universal, without LED	4 x 0.75 mm ²	PVC, gray	   
934889077	GAN31LU-A0U-6101000	3 + PE	10 M	250 V/universal, without LED	4 x 0.75 mm ²	PVC, gray	   

Conversion table mm² to AWG on page 22.

Be Certain with Belden

Order Information

Order No.	Order Designation	No. of Pins	Cable Length	Rated Voltage	Conductor Size	Jacket	Characteristics
934889587	GAN200U-A0U-6060200	2	2 M	50 V/universal, without LED	2 x 0.75 mm ²	PUR, gray	UL VDE C   
934889588	GAN200U-A0U-6060500	2	5 M	50 V/universal, without LED	2 x 0.75 mm ²	PUR, gray	UL VDE C   
10549	GAN200U-A0U-6061000	2	10 M	50 V/universal, without LED	2 x 0.75 mm ²	PUR, gray	UL VDE C   
934889573	GAN210U-A0U-6030200	2 + PE	2 M	250 V/universal, without LED	3 x 0.75 mm ²	PUR, gray	UL VDE C   
934889574	GAN210U-A0U-6030500	2 + PE	5 M	250 V/universal, without LED	3 x 0.75 mm ²	PUR, gray	UL VDE C   
10550	GAN210U-A0U-6031000	2 + PE	10 M	250 V/universal, without LED	3 x 0.75 mm ²	PUR, gray	UL VDE C   
934889583	GAN220U-A0U-6030200	2 + 2 PE	2 M	250 V/universal, without LED	3 x 0.75 mm ²	PUR, gray	UL VDE C   
934889584	GAN220U-A0U-6030500	2 + 2 PE	5 M	250 V/universal, without LED	3 x 0.75 mm ²	PUR, gray	UL VDE C   
10551	GAN220U-A0U-6031000	2 + 2 PE	10 M	250 V/universal, without LED	3 x 0.75 mm ²	PUR, gray	UL VDE C   
10552	GAN220U-A0U-2260200	2 + 2 PE	2 M	250 V/universal, without LED	3 x 0.50 mm ²	PUR, black	UL VDE C   
934889504	GAN220U-A0U-2260500	2 + 2 PE	5 M	250 V/universal, without LED	3 x 0.50 mm ²	PUR, black	UL VDE C   
934889505	GAN220U-A0U-2261000	2 + 2 PE	10 M	250 V/universal, without LED	3 x 0.50 mm ²	PUR, black	UL VDE C   
934889506	GAN310U-A0U-7430200	3 + PE	2 M	250 V/universal, without LED	4 x 0.50 mm ²	PVC, black	UL VDE C   
934889507	GAN310U-A0U-7430500	3 + PE	5 M	250 V/universal, without LED	4 x 0.50 mm ²	PVC, black	UL VDE C   
9647	GAN310U-A0U-7431000	3 + PE	10 M	250 V/universal, without LED	4 x 0.50 mm ²	PVC, black	UL VDE C   
934889509	GAN310U-A0U-7440200	3 + PE	2 M	250 V/universal, without LED	4 x 0.50 mm ²	PUR, black	UL VDE C   
934889510	GAN310U-A0U-7440500	3 + PE	5 M	250 V/universal, without LED	4 x 0.50 mm ²	PUR, black	UL VDE C   
934889511	GAN310U-A0U-7441000	3 + PE	10 M	250 V/universal, without LED	4 x 0.50 mm ²	PUR, black	UL VDE C   
934889578	GAN310U-A0U-6040200	3 + PE	2 M	250 V/universal, without LED	4 x 0.75 mm ²	PUR, gray	UL VDE C   
934889579	GAN310U-A0U-6040500	3 + PE	5 M	250 V/universal, without LED	4 x 0.75 mm ²	PUR, gray	UL VDE C   
9641	GAN310U-A0U-6041000	3 + PE	10 M	250 V/universal, without LED	4 x 0.75 mm ²	PUR, gray	UL VDE C   

Conversion table mm² to AWG on page 22.