

One-phase switching power supply
regulated, 240 W



Identification	Type	DRA 240-24B
	Part-No.	722759

Input

Nominal voltage	AC 115 / 230 V (auto select)
Operation voltage range	AC 88 V - 264 V / DC 120 V - 375 V
Line frequency	47 Hz – 63 Hz
Rated current	U _i = AC 115 V: 2.4 A / U _i = AC 230 V: 1.2 A
Inrush current	U _i = AC 115 V: 30 A / U _i = AC 230 V: 60 A
Internal fuse	T6, 3 A / AC 250 V
External fuse	Mini-circuit breaker: B 10 A, C 6 A
Power Factor Correction P.F.C.	0.7

Load Side

Rated voltage output	DC 24 V
Rated current output	10 A
Low power loss	35 W (AC 230 V)
Voltage trim range	22.5–28.5
Accuracy	±1 %
Line regulation	±0.5 %
Load regulation	Single ±1 %, Parallel ±5 %
Rise time	1 s
Temperature coefficient	±0.03 % / °C

18.02.2014 – Subject to technical modification

Part-No. 722759

USA: LUTZE INC.

13330 South Ridge Drive • Charlotte, NC 28273, USA
Tel. +1 (704) 504-0222 • Fax +1 (704) 504-0223
www.lutze.com • info@lutze.com

United Kingdom: LÜTZE Ltd.

Unit 3, Sandy Hill Park
Sandy Way, Amington • GB-Tamworth, Staffs B77 4DU
Tel. +44 (0)1827 31333-0 • Fax +44 (0)1827 31333-2
www.lutze.com • sales.gb@lutze.co.uk



SYSTEMATIC TECHNOLOGY

Technical data sheet • Power supply

Ripple & Noise	100 mV
Hold up time	$V_{in}= 115\text{ V}$: 25 ms / $V_{in}= 230\text{ V}$: 30 ms
Status indication DC ON LED green	$\geq 17.6\text{--}19.4\text{ V}$
Status indication DC LOW LED red	$\leq 17.6\text{--}19.4\text{ V}$
Parallel/redundant operation	max 3 devices with 90 % load current each, switching with switch S/P
Efficiency	89 %
Rated over load protection	105–145 %
Over voltage protection	120–145 %
Short circuit characteristics	Current limit

General

Switching frequency	approx. 40 kHz
Insulation voltage input/output	3.0 kV _{eff}
Insulation voltage input / ground	AC 1.5 kV _{eff}
Insulation resistance at DC 500 V	100 M Ω
Operation temperature range	-40 °C – 71 °C (derating)
Derating	-2.5% / °C starting at 61 °C
Storage temperature range	-25 °C – 85 °C
M.T.B.F.	423000 h
Relative humidity	20–90% RH, non-condensing
Dimensions (w × h × d)	64.0 × 124.5 × 116.6 mm
Cooling	Natural air cooling, 25 mm distance on all sides
Installation position	vertical
Housing material	metal
Protection class	IP 20
Field installation	rail TS 35 (EN 50022)
Application height	4850 m
IP rating	I (SELV, PELV)
Overvoltage category	II
Pollution degree	2
Weight (kg/piece)	1.000
Termination	Screw terminal: 0.2–2.5 mm ² - pluggable, max. 0.56 Nm
Approvals	UL: UL 508 listed; cUL: UL 60950-1; TÜV: EN 60950, CE: EN 61000-6-3, EN 55022 Class B, EN 61000-3-2, EN 61000-3-3, EN 61000-6-2, EN 55024 Class I, Division 2, Groups A, B, C and D

Monitoring

DC ON Control (Rdy)	Normally open
Switching voltage	DC 60 V
Switching current	max. 300 mA
Insulation voltage	DC 500 V

18.02.2014 – Subject to technical modification

Part-No. 722759

USA: LUTZE INC.

13330 South Ridge Drive • Charlotte, NC 28273, USA
Tel. +1 (704) 504-0222 • Fax +1 (704) 504-0223
www.lutze.com • info@lutze.com

United Kingdom: LÜTZE Ltd.

Unit 3, Sandy Hill Park
Sandy Way, Amington • GB-Tamworth, Staffs B77 4DU
Tel. +44 (0)1827 31333-0 • Fax +44 (0)1827 31333-2
www.lutze.com • sales.gb@lutze.co.uk



SYSTEMATIC TECHNOLOGY

Technical data sheet • Power supply

Dimensions

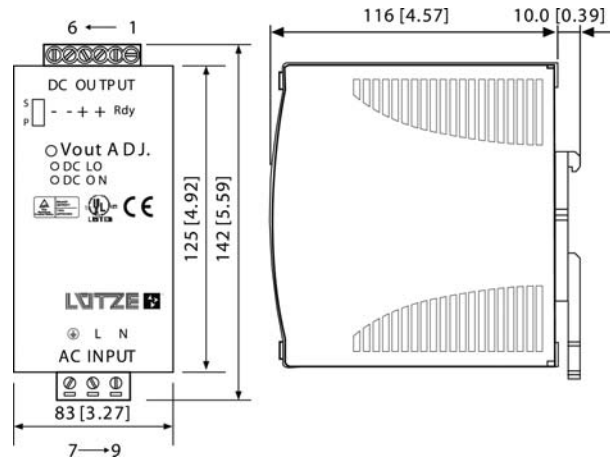

PIN assignment

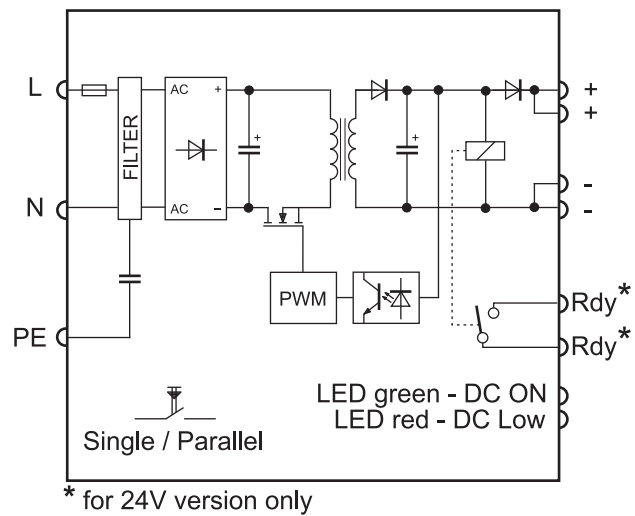

18.02.2014 – Subject to technical modification

Part-No. 722759

USA: LUTZE INC.

13330 South Ridge Drive • Charlotte, NC 28273, USA
 Tel. +1 (704) 504-0222 • Fax +1 (704) 504-0223
 www.lutze.com • info@lutze.com

United Kingdom: LÜTZE Ltd.

Unit 3, Sandy Hill Park
 Sandy Way, Amington • GB-Tamworth, Staffs B77 4DU
 Tel. +44 (0)1827 31333-0 • Fax +44 (0)1827 31333-2
 www.lutze.com • sales.gb@lutze.co.uk



SYSTEMATIC TECHNOLOGY

Derating

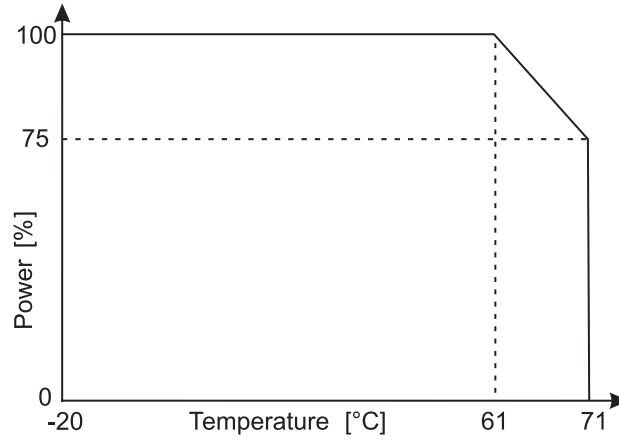

Parallel/redundant mode

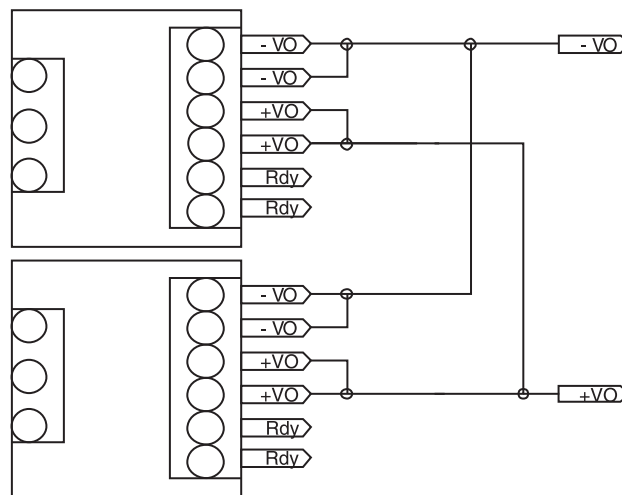

18.02.2014 – Subject to technical modification

Part-No. 722759

USA: LUTZE INC.

13330 South Ridge Drive • Charlotte, NC 28273, USA

Tel. +1 (704) 504-0222 • Fax +1 (704) 504-0223

www.lutze.com • info@lutze.com

United Kingdom: LÜTZE Ltd.

Unit 3, Sandy Hill Park

Sandy Way, Amington • GB-Tamworth, Staffs B77 4DU

Tel. +44 (0)1827 31333-0 • Fax +44 (0)1827 31333-2

www.lutze.com • sales.gb@lutze.co.uk



SYSTEMATIC TECHNOLOGY

Short circuit characteristics

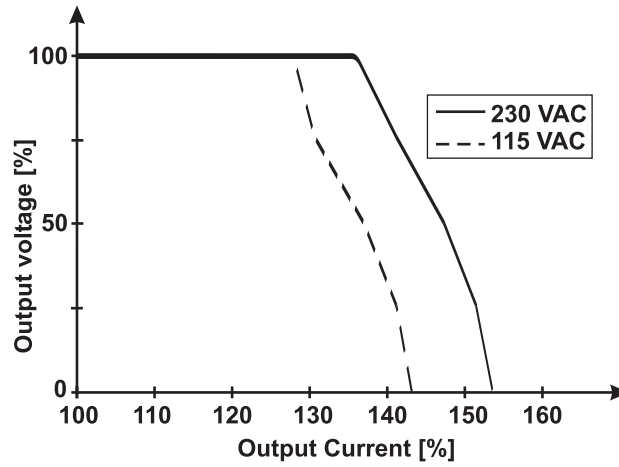

18.02.2014 – Subject to technical modification

Part-No. 722759

USA: LUTZE INC.

13330 South Ridge Drive • Charlotte, NC 28273, USA
Tel. +1 (704) 504-0222 • Fax +1 (704) 504-0223
www.lutze.com • info@lutze.com

United Kingdom: LÜTZE Ltd.

Unit 3, Sandy Hill Park
Sandy Way, Amington • GB-Tamworth, Staffs B77 4DU
Tel. +44 (0)1827 31333-0 • Fax +44 (0)1827 31333-2
www.lutze.com • sales.gb@lutze.co.uk



SYSTEMATIC TECHNOLOGY