

REVISION HISTORY				
REV	ECN No.	CHANGE DESCRIPTION	DATE	BY
00			2018-09-01	Jianhua Wang

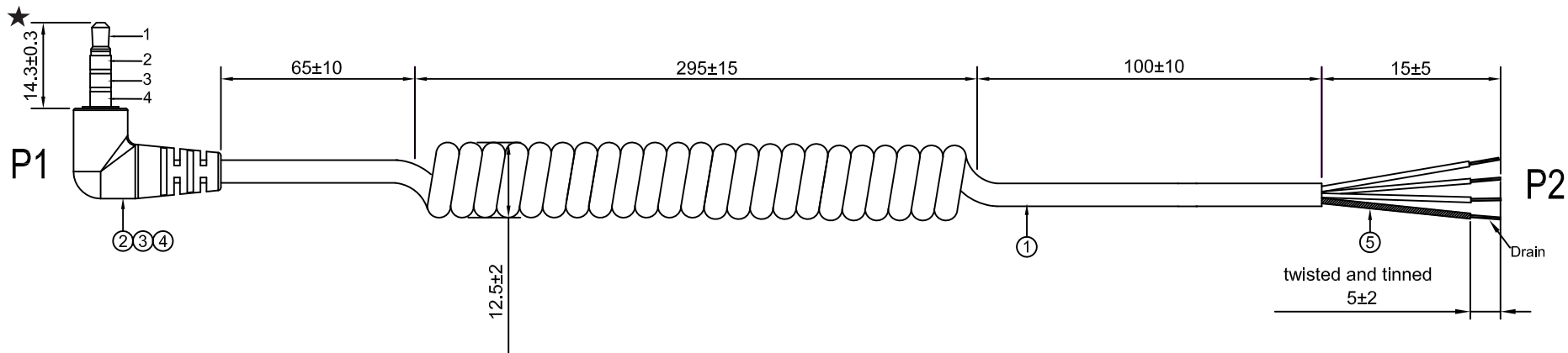

**NOTES:**

1. All the materials are compliant with RoHS requirement.
2. All dimension are mm.
3. Cable assembly meet with IPC-620 class2 standard.
4. The dimension with "★" shall be strictly controlled.

**ELECTEICAL CHARACTERISTICS:**

1. Contact resistance:  $<1 \Omega$
2. Insulation resistance: 300V/DC,  $>20M \Omega$
3. All cable assemblies to be 100% tested for continuity, short and miswire.

**Wiring diagram**

P1		P2
1	— Red —	Open
2	— White —	Open
3	— Green —	Open
4	— Drain —	Open

ITEM	QTY	PART DESCRIPTION	CY PN
5	10mm	Heat shrinking tube, UL94V-0, 125°C 600V VW-1 black.	50-0090
4	-6g	Innermold.LD-PE.	70-0011
3	-10g	Overmold.PVC 45P,color:black	70-0003
2	1PC	3.5mm 4 poles plug,nickel plated	90-0006
1	-490mm	Cable, 26AWG/3C (red,white,green)+drain+AL-mylar jacket: TPU(mouse-proof), OD3.5±0.1, VFF,color:black	11-0060



**Proprietary Notice**

This document is the property of Changzhou ChuangYue Electronics CO.,Ltd. The information contained herein is not to be disclosed to anyone without the express written consent of CZCY.

TOLERANCE UNLESS OTHERWISE SPECIFIED  
 .XX ±  
 .X ±  
 X ±  
 .XX° ±  
 .X° ±  
 X° ±

DRAWN	DATE	ITEM DESCRIPTION	
Jianhua Wang	2018-09-01	DC 3.5 plug 4 poles cable ass'y	
ENGR Linson Zhang	2018-09-01		
ENG APPD. Rong	2018-09-01		
UNIT: mm		ROHS COMPLIANT:	PART NO. ELE-000104
SCALE 1:1	SIZE A4	DRAWING TYPE:	DRAWING NO.
SHEET 1	OF 1		

REVISION HISTORY				
REV	ECN No.	CHANGE DESCRIPTION	DATE	BY
00			2018-09-01	Jianhua Wang

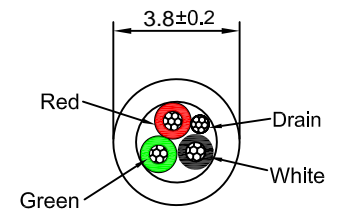
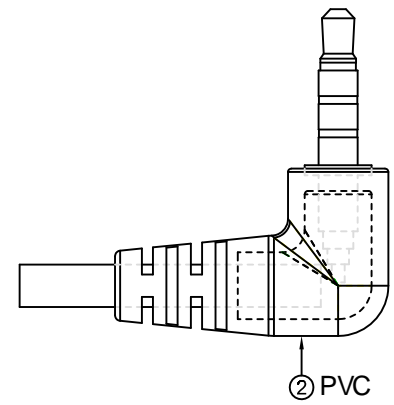
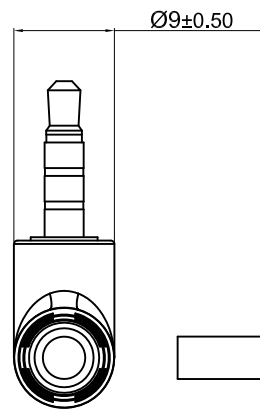
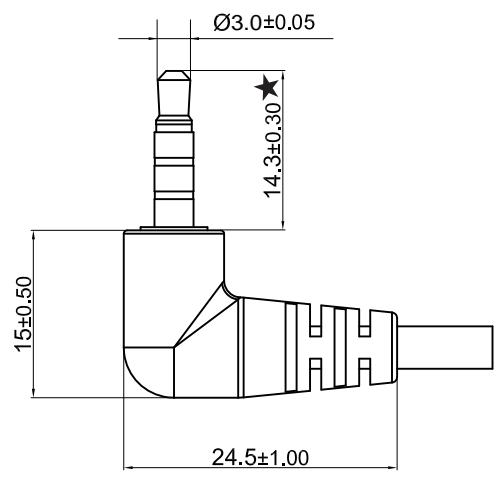
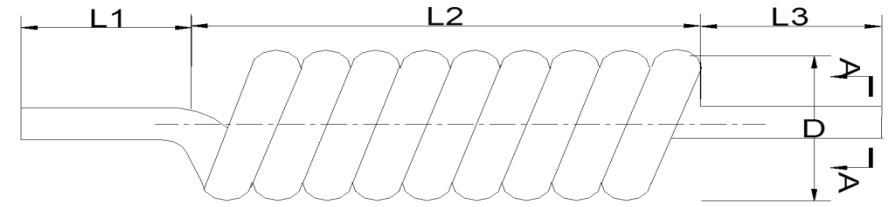
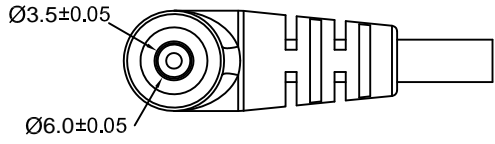

SEC: A--A

L1	100 ± 10
L2	295 ± 15
L3	130 ± 10
D	12.5 ± 2.0
L	2470

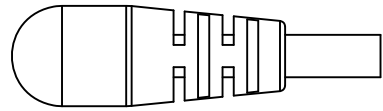

**Proprietary Notice**

This document is the property of Changzhou ChuangYue Electronics CO.,Ltd. The information contained herein is not to be disclosed to anyone without the express written consent of CZCY.

TOLERANCE UNLESS OTHERWISE SPECIFIED  
 .XX ±  
 .X ±  
 X ±  
 .XX° ±  
 .X° ±  
 X° ±

ITEM	Q'TY	PART DESCRIPTION	CY PN
DRAWN Jianhua Wang	DATE 2018-09-01	ITEM DESCRIPTION	
ENGR Linson Zhang	DATE 2018-09-01	DC 3.5 plug 4 poles cable ass'y	
ENG APPD. Rong	DATE 2018-09-01		
UNIT: mm		ROHS COMPLIANT:	PART NO. ELE-000104
SCALE 1:1	SIZE A4	DRAWING TYPE:	DRAWING NO.
SHEET 1	OF 1		