

350779-1 ✓ ACTIVE

MATE-N-LOK | Universal MATE-N-LOK

TE Internal #: 350779-1

Housing, Plug, Wire-to-Board / Wire-to-Wire, 4 Position, 6.35 mm [.25 in] Centerline, Wire & Cable, Universal MATE-N-LOK, Rectangular Power Connectors

[View on TE.com >](#)



Connectors > Power Connectors > Rectangular Power > Rectangular Power Connectors

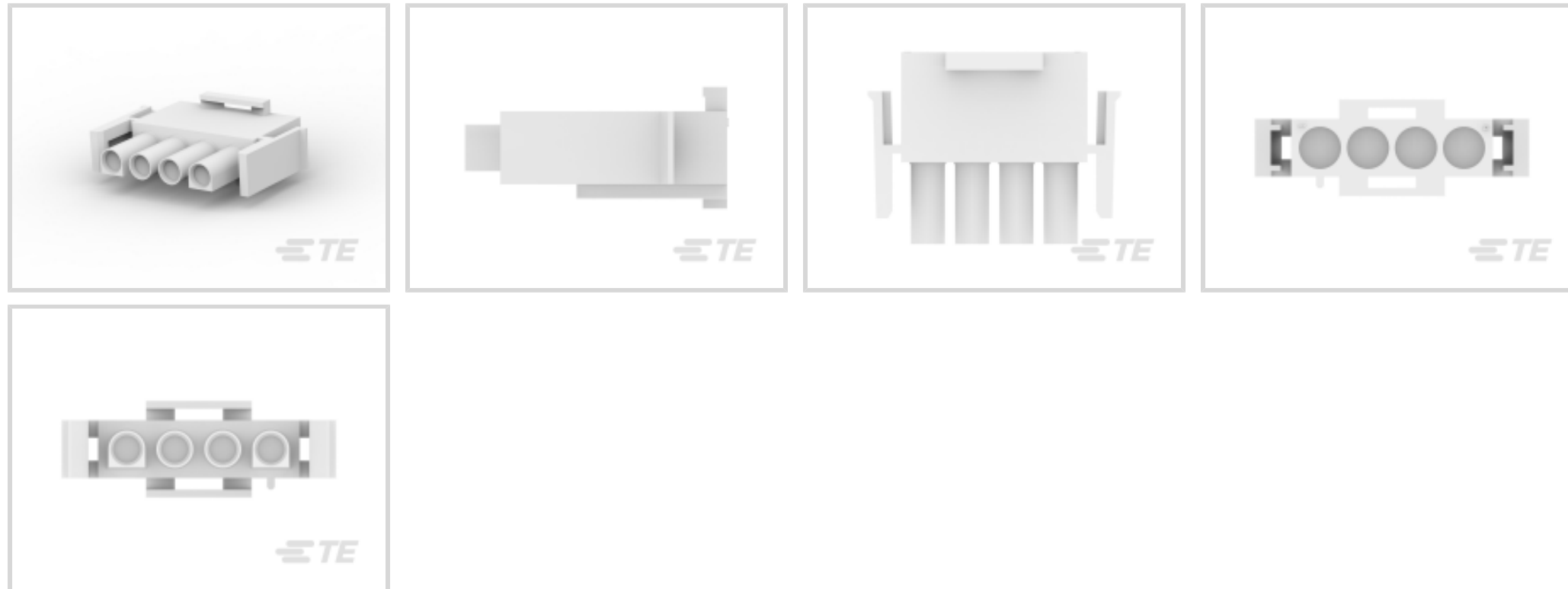

Rectangular Power Connector Type: **Housing**

Connector & Housing Type: **Plug**

Connector System: **Wire-to-Board, Wire-to-Wire**

Number of Positions: **4**

Centerline (Pitch): **6.35 mm [.25 in]**

Features

Dimensions

Product Width	7.52 mm
Product Length	26.7 mm
Connector Height	27.4 mm

Packaging Features

Packaging Quantity	1
Packaging Method	Package

Contact Features

Multiple Contact Types	Without
Contact Layout	Inline
Contact Retention Within Housing	Without
Contact Type	Socket

Mechanical Attachment

Panel Mount Feature	Without
Connector Mounting Type	Cable Mount (Free-Hanging)



Industry Standards

Compatible With Agency/Standards Products	UL, VDE, CSA
UL Rating	Recognized
Compatible With Approved Standards Products	UL E28476
CSA Rating	LR 7189, Certified
UL Flammability Rating	UL 94V-0
Glow Wire Rating	Standard Part - Not Glow Wire

Product Type Features

Rectangular Power Connector Type	Housing
Connector & Housing Type	Plug
Connector System	Wire-to-Board, Wire-to-Wire
Sealable	No
Connector & Contact Terminates To	Wire & Cable

Configuration Features

Number of Positions	4
Number of Rows	1

Electrical Characteristics

Operating Voltage	600 VAC
-------------------	---------

Termination Features

Termination Method to Wire & Cable	Crimp
------------------------------------	-------

Housing Features

Centerline (Pitch)	6.35 mm [.25 in]
Housing Color	Natural
Housing Material	Nylon

Usage Conditions

Operating Temperature Range	-55 – 105 °C [-67 – 221 °F]
-----------------------------	-----------------------------

Operation/Application

Circuit Application	Power & Signal
---------------------	----------------

Other

EU RoHS Compliance	Compliant
EU ELV Compliance	Compliant



Product Compliance

[For compliance documentation, visit the product page on TE.com>](#)

EU RoHS Directive 2011/65/EU	Compliant
EU ELV Directive 2000/53/EC	Compliant
China RoHS 2 Directive MIIT Order No 32, 2016	No Restricted Materials Above Threshold
EU REACH Regulation (EC) No. 1907/2006	Current ECHA Candidate List: JUNE 2024 (241) Candidate List Declared Against: JUNE 2024 (241) Does not contain REACH SVHC
Halogen Content	Low Halogen - Br, Cl, F, I < 900 ppm per homogenous material. Also BFR/CFR/PVC Free
Solder Process Capability	Not applicable for solder process capability

Product Compliance Disclaimer

This information is provided based on reasonable inquiry of our suppliers and represents our current actual knowledge based on the information they provided. This information is subject to change. The part numbers that TE has identified as EU RoHS compliant have a maximum concentration of 0.1% by weight in homogenous materials for lead, hexavalent chromium, mercury, PBB, PBDE, DBP, BBP, DEHP, DIBP, and 0.01% for cadmium, or qualify for an exemption to these limits as defined in the Annexes of Directive 2011/65/EU (RoHS2). Finished electrical and electronic equipment products will be CE marked as required by Directive 2011/65/EU. Components may not be CE marked. Additionally, the part numbers that TE has identified as EU ELV compliant have a maximum concentration of 0.1% by weight in homogenous materials for lead, hexavalent chromium, and mercury, and 0.01% for cadmium, or qualify for an exemption to these limits as defined in the Annexes of Directive 2000/53/EC (ELV). Regarding the REACH Regulation, the information TE provides on SVHC in articles for this part number is based on the latest European Chemicals Agency (ECHA) 'Guidance on requirements for substances in articles' posted at this URL: <https://echa.europa.eu/guidance-documents/guidance-on-reach>

Compatible Parts



TE Part # 1-2213753-3
4 POS HIGH TEMP MATE-N-LOK
SOCKET ASSM



TE Part # 770234-3
UMNL GRND PIN PTPPHBZ















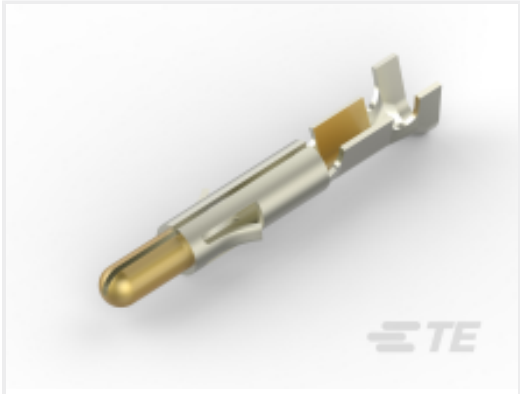

TE Part # 926894-3
UNIV.M-N-L.PIN

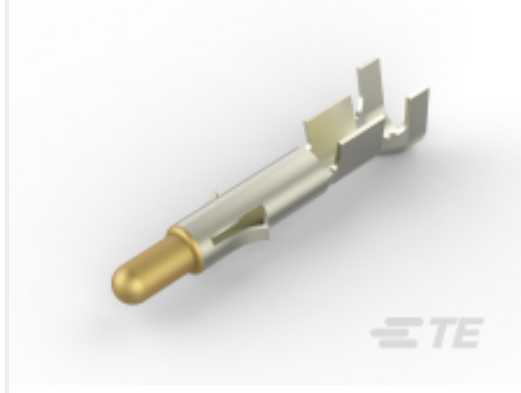

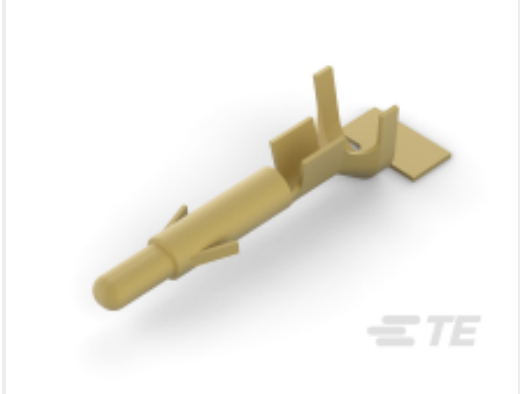



TE Part # 926893-3
UNIV.M-N-L.SOCKET

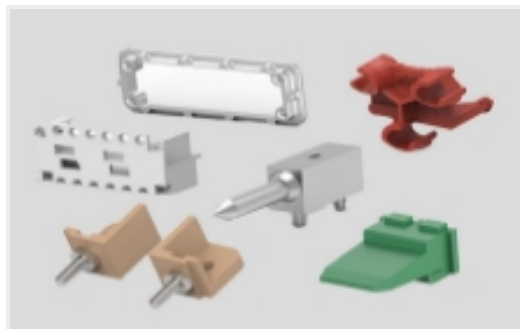

 <p>TE Part # 926885-3 UNIV.M-N-L.PIN</p>	 <p>TE Part # 926887-3 UNIV.M-N-L.PIN</p>	 <p>TE Part # 926882-3 UMNL SOK PTPPHBZ</p>	 <p>TE Part # 1-350779-9 04P UMNL V0 PLUG HSG BLACK</p>
 <p>TE Part # 350561-1 UMNL PIN 24-18 .0126 PTPBR</p>	 <p>TE Part # 350689-6 UMNL SOK 24-18 AUPHBZ L/P</p>	 <p>TE Part # 350570-1 UMNL SOK 24-18 PTPBR</p>	 <p>TE Part # 350707-1 UMNL SPLIT PIN 20-14 PTPBR L/P</p>
 <p>TE Part # 350707-2 UMNL SPLIT PIN 20-14 AUBR L/P</p>	 <p>TE Part # 350547-7 UMNL PIN 20-14 AUBR L/P</p>	 <p>TE Part # 350925-6 UMNL SOK AUNI/PHBZ</p>	 <p>TE Part # 350218-3 UMNL PIN 20-14 .0125PTPPHBZ</p>
 <p>TE Part # 350707-7 UMNL SPLIT PIN 20-14 AUBR L/P</p>	 <p>TE Part # 350780-1 04P UMNL CAP HSG</p>	 <p>TE Part # 350873-3 UMNL PIN 18-14 .0125 PTPPHBZ</p>	 <p>TE Part # 350874-1 UMNL SOK 18-14 .0126 PTPBR</p>

Also in the Series | **Universal MATE-N-LOK**

 <p>Circular Power Connectors(2)</p>	 <p>Connector Contacts(209)</p>	 <p>Connector Hardware(12)</p>	 <p>Power Contacts(209)</p>
---	---	---	--



Rectangular Power Connectors(370)



Standard Circular Connectors(1)

Customers Also Bought



TE Part #350735-1
12P UMNL PLUG HSG



TE Part #350720-1
09P UMNL PLUG HSG



TE Part #350767-1
03P UMNL CAP HSG V0



TE Part #350809-1
05P UMNL PLUG HSG



TE Part #794273-1
04P UMNL INTERFACE SEAL



TE Part #350778-1
02P UMNL CAP HSG



TE Part #350781-1
06P UMNL CAP HSG



TE Part #350715-1
06P UMNL PLUG HSG

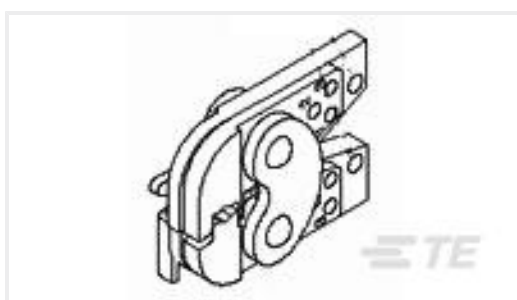

TE Part #752942-1
CRIMPING JAW HEAD ASSY

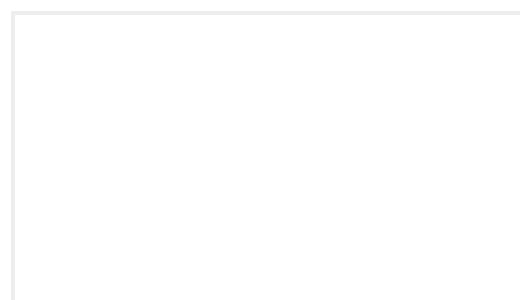

TE Part #803761-SF
FN9222R-6-06

Documents

Product Drawings

[04P UMNL PLUG HSG](#)

English

CAD Files

[3D PDF](#)

3D

Customer View Model

[ENG_CVM_CVM_350779-1_BB.2d_dxf.zip](#)



English

Customer View Model

[ENG_CVM_CVM_350779-1_BB.3d_igs.zip](#)

English

Customer View Model

[ENG_CVM_CVM_350779-1_BB.3d_stp.zip](#)

English

3D PDF

English

Customer View Model

[ENG_CVM_350779-1_AB1.2d_dxf.zip](#)

English

Customer View Model

[ENG_CVM_350779-1_AB1.3d_igs.zip](#)

English

Customer View Model

[ENG_CVM_350779-1_AB1.3d_stp.zip](#)

English

By downloading the CAD file I accept and agree to the [Terms and Conditions](#) of use.

Datasheets & Catalog Pages

[SOFT_SHELL_PIN_SOCKET_CONNECTORS_STANDARD_DENSITY](#)

English

Product Specifications

[Application Specification](#)

English

Instruction Sheets

[Instruction Sheet \(U.S.\)](#)

English

[Instruction Sheet \(U.S.\)](#)

English

Agency Approvals

[VDE Certificate](#)

English

[VDE Certificate](#)

English