

52042-3 ✓ ACTIVE

PLASTI-GRIP

TE Internal #: 52042-3

Closed Ring Tongue Terminal, 6 AWG, 1/4 / M6 Stud Size, 6.73 mm [.265 in] Stud Diameter, Closed Barrel, Straight, Tin, PLASTI-GRIP

[View on TE.com >](#)



Terminals & Splices > Ring Terminals

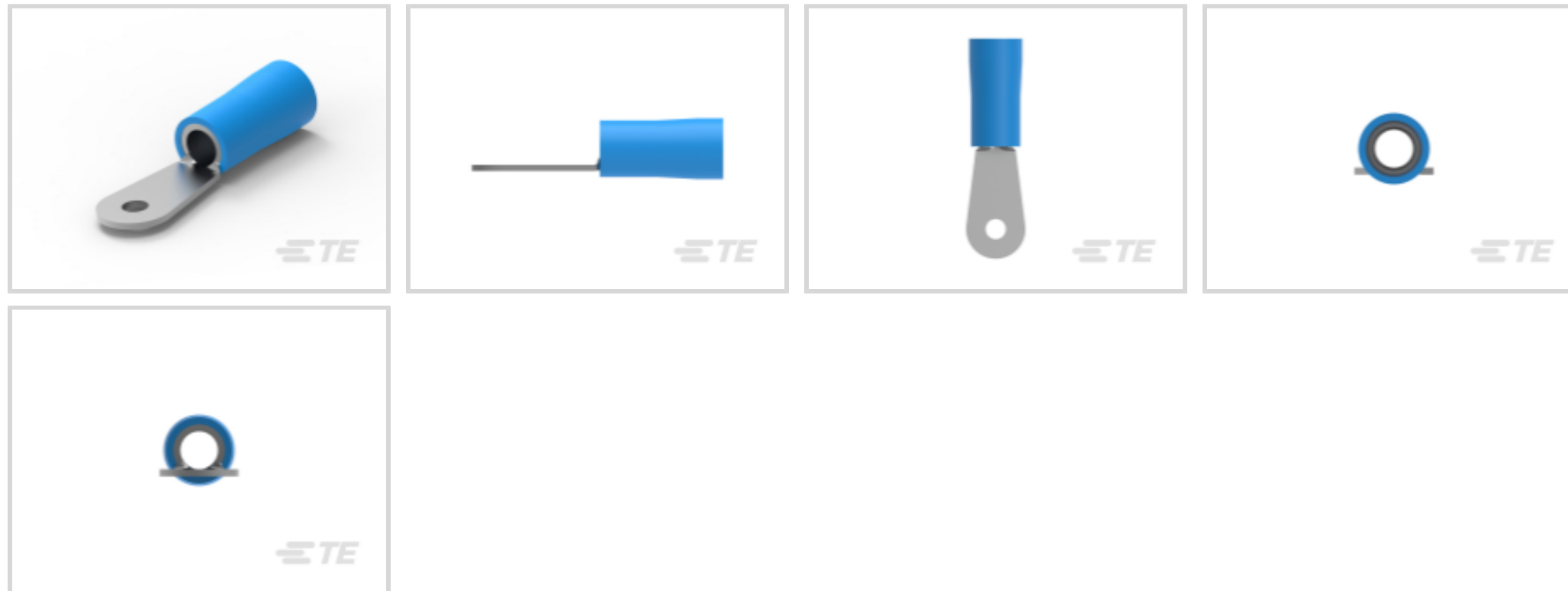

Ring Terminal Product Type: Closed Ring Tongue Terminal

Wire Size: 20800 – 33100 CMA

Stud Size: 1/4, M6

Features

Configuration Features

Number of Holes	1
-----------------	---

Mechanical Attachment

Wire Insulation Support	With
-------------------------	------

Electrical Characteristics

Voltage Rating	600 V
----------------	-------

Industry Standards

Government Qualified Terminal	No
-------------------------------	----

Body Features

Insulation Sleeve Color	Blue
-------------------------	------

Stripe Color	Blue
--------------	------

Packaging Features

Packaging Quantity	100
--------------------	-----

Packaging Method	Loose Piece
------------------	-------------

Product Type Features

Ring Terminal Product Type	Closed Ring Tongue Terminal
----------------------------	-----------------------------



Stud Size	1/4, M6
Sealable	No
Wire Insulation Support Retention Type	Insulation Support

Contact Features

Barrel Type	Closed
Terminal Orientation	Straight
Terminal Plating Material	Tin

Dimensions

Wire Size	20800 – 33100 CMA
Stud Diameter	6.73 mm [.265 in]
Tongue Thickness	.79 mm [.031 in]
Product Length	47.47 mm [1.869 in]
Compatible Insulation Diameter (Max)	9.14 mm [.36 in]
Compatible Insulation Diameter Range	9.14 mm [.36 in]

Usage Conditions

Insulation Option	Partially Insulated
Operating Temperature Range	105 °C [221 °F]

Operation/Application

Compatible With Wire Base Material	Copper
Compatible With Wire Plating Material	Tin

Other

EU RoHS Compliance	Compliant
EU ELV Compliance	Compliant

Product Compliance

[For compliance documentation, visit the product page on TE.com>](#)

EU RoHS Directive 2011/65/EU	Compliant
EU ELV Directive 2000/53/EC	Compliant
China RoHS 2 Directive MIIT Order No 32, 2016	No Restricted Materials Above Threshold
EU REACH Regulation (EC) No. 1907/2006	Current ECHA Candidate List: JUNE 2024 (241) Candidate List Declared Against: JUNE 2024 (241) Does not contain REACH SVHC







Halogen Content	Not Low Halogen - contains Br or Cl > 900 ppm.
-----------------	--

Solder Process Capability	Not applicable for solder process capability
---------------------------	--

Product Compliance Disclaimer

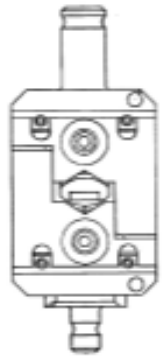
This information is provided based on reasonable inquiry of our suppliers and represents our current actual knowledge based on the information they provided. This information is subject to change. The part numbers that TE has identified as EU RoHS compliant have a maximum concentration of 0.1% by weight in homogenous materials for lead, hexavalent chromium, mercury, PBB, PBDE, DBP, BBP, DEHP, DIBP, and 0.01% for cadmium, or qualify for an exemption to these limits as defined in the Annexes of Directive 2011/65/EU (RoHS2). Finished electrical and electronic equipment products will be CE marked as required by Directive 2011/65/EU. Components may not be CE marked. Additionally, the part numbers that TE has identified as EU ELV compliant have a maximum concentration of 0.1% by weight in homogenous materials for lead, hexavalent chromium, and mercury, and 0.01% for cadmium, or qualify for an exemption to these limits as defined in the Annexes of Directive 2000/53/EC (ELV). Regarding the REACH Regulation, the information TE provides on SVHC in articles for this part number is based on the latest European Chemicals Agency (ECHA) 'Guidance on requirements for substances in articles' posted at this URL: <https://echa.europa.eu/guidance-documents/guidance-on-reach>

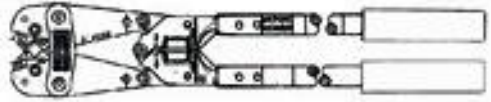
Compatible Parts

 <p>TE Part # 52042 TERMINAL,R PG 6 8</p>	 <p>TE Part # 1490535-1 HYP10 PLASTI-GRIP 6AWG DIE SET</p>	 <p>TE Part # 48753-1 HYP8 PLASTI-GRIP 6AWG 69051 DIE SET</p>	 <p>TE Part # 47821 HYP8 TERMINYL 6AWG DIE SET</p>
 <p>TE Part # 601129-2 HAND TOOL (A.S.I.)</p>	 <p>TE Part # 1490598-1 HYP10 TERMINYL 6AWG DIE SET</p>		

Also in the Series | PLASTI-GRIP

 <p>Compression Connectors(3)</p>	 <p>Crimp Wire Pins, Tabs & Ferrules(18)</p>	 <p>Ring Terminals(297)</p>	 <p>Spade Terminals(157)</p>
--	---	--	---



Splices(44)

Customers Also Bought



TE Part #794215-1
24P MINI UMNL2 CAP HSG UL94V0



TE Part #52263-1
TERMINAL R PG 8 10

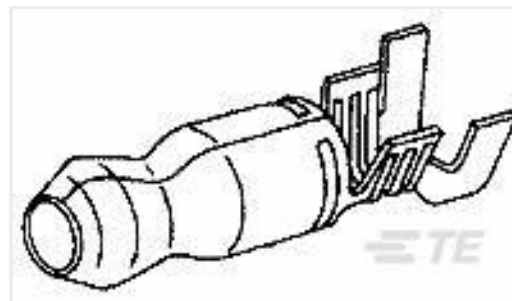

TE Part #60660-1
SHUR PLUG 180 18-14 AWG TPBR



TE Part #130527
PIDG SPADE



TE Part #776433-3
AS16,PLUG ASSY,ST,06P,N SEAL,
CODE C



TE Part #327743
TERMINAL,PIDG R 16-14HD 1/4

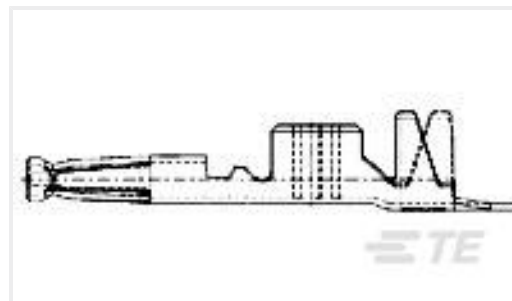

TE Part #1719532-1
MQS0,63 Sn rec CB unseal. AWG18



TE Part #2-1393366-2
GET-SOCKET TERMINAL, SILVER VE

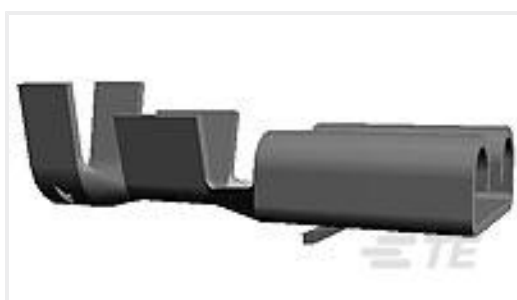

TE Part #160914-2
FF 250 REC 4-6MM2 TPBR



TE Part #60650-2
250 FASTON FLAG REC 18-14 AWG
TPBR

Documents

Product Drawings

[TERMINAL,R PG 6 1/4](#)

English

CAD Files

[3D PDF](#)

3D

[Customer View Model](#)

[ENG_CVM_CVM_52042-3_AD.2d_dxf.zip](#)



English

Customer View Model

[ENG_CVM_CVM_52042-3_AD.3d_igs.zip](#)

English

Customer View Model

[ENG_CVM_CVM_52042-3_AD.3d_stp.zip](#)

English

By downloading the CAD file I accept and agree to the [Terms and Conditions](#) of use.

Product Specifications

[Application Specification](#)

English

Instruction Sheets

[Instruction Sheet \(U.S.\)](#)

English

Agency Approvals

[UL Report](#)

English

[UL Report](#)

English