

One-phase switching power supply
regulated, 120 W



Identification	Type	DRAN 120-24B
	Part-No.	722758

Input

Nominal voltage	AC 115 / 230 V (auto select)
Operation voltage range	AC 90–132 V; AC 186–264 V / DC 210–370 V
Line frequency	47 Hz–63 Hz
Rated current	$U_i = AC 115 V: 1.25 A / U_i = AC 230 V: 0.63 A$
Inrush current	$U_i = AC 115 V: 24 A / U_i = AC 230 V: 48 A$
Internal fuse	T3, 15 A / AC 250 V
External fuse	Mini-circuit breaker: B 6 A
Power Factor Correction P.F.C.	0.7

Load Side

Rated voltage output	DC 24 V
Rated current output	5 A
Low power loss	20 W (AC 230 V)
Voltage trim range	22.5–28.5 V
Accuracy	±1 %
Line regulation	±0.5 %
Load regulation	Single ±1 %, Parallel ±5 %
Rise time	1 s
Temperature coefficient	±0.03 % / °C

21.09.2012 – Subject to technical modification

Part-No. 722758

USA: LUTZE INC.

13330 South Ridge Drive • Charlotte, NC 28273, USA
Tel. +1 (704) 504-0222 • Fax +1 (704) 504-0223
www.lutze.com • info@lutze.com

United Kingdom: LÜTZE Ltd.

Unit 3, Sandy Hill Park
Sandy Way, Amington • GB-Tamworth, Staffs B77 4DU
Tel. +44 (0)1827 31333-0 • Fax +44 (0)1827 31333-2
www.lutze.com • sales.gb@lutze.co.uk



SYSTEMATIC TECHNOLOGY

Technical data sheet • Power supply

Ripple & Noise	50 mV
Hold up time	$V_{in}= 115\text{ V}$: 25 ms / $V_{in}= 230\text{ V}$: 30 ms
Status indication DC ON LED green	$\geq 17.6\text{--}19.4\text{ V}$
Status indication DC LOW LED red	$\leq 17.6\text{--}19.4\text{ V}$
Parallel/redundant operation	max. 3 units at 90% load current, manual switch
Efficiency	86 %
Rated over load protection	105–125 %
Over voltage protection	125–145 %
Short circuit characteristics	Current limit

General

Switching frequency	approx. 80 kHz
Insulation voltage input/output	3.0 kV _{eff}
Insulation voltage input / ground	AC 1.5 kV _{eff}
Insulation resistance at DC 500 V	100 M Ω
Operation temperature range	-25 °C – 70 °C (derating)
Derating	-2.5% / °C starting at 60 °C
Storage temperature range	-25 °C – 85 °C
M.T.B.F.	450000 h
Relative humidity	20–90% RH, non-condensing
Dimensions (w × h × d)	63.5×142.0×116.0 mm
Cooling	Natural air cooling, 25 mm distance on all sides
Installation position	vertical
Housing material	metal
Protection class	IP 20
Field installation	rail TS 35 (EN 50022)
Application height	2000 m
IP rating	I (SELV, PELV)
Overvoltage category	II
Pollution degree	2
Weight (kg/piece)	0.920
Termination	Screw terminal: 0.2–2.5 mm ² - pluggable, max. 0.56 Nm
Approvals	UL: UL 508 listed; cUL: UL 60950-1; TÜV: EN 60950, CE: EN 61000-6-3, EN 55022 Class B, EN 61000-3-2, EN 61000-3-3, EN 61000-6-2, EN 55024

Monitoring

DC ON Control (Rdy)	Normally open
Switching voltage	DC 60 V
Switching current	max. 300 mA
Insulation voltage	DC 500 V

21.09.2012 – Subject to technical modification

Part-No. 722758

USA: LUTZE INC.

13330 South Ridge Drive • Charlotte, NC 28273, USA
Tel. +1 (704) 504-0222 • Fax +1 (704) 504-0223
www.lutze.com • info@lutze.com

United Kingdom: LÜTZE Ltd.

Unit 3, Sandy Hill Park
Sandy Way, Amington • GB-Tamworth, Staffs B77 4DU
Tel. +44 (0)1827 31333-0 • Fax +44 (0)1827 31333-2
www.lutze.com • sales.gb@lutze.co.uk



SYSTEMATIC TECHNOLOGY

Technical data sheet • Power supply

Dimensions

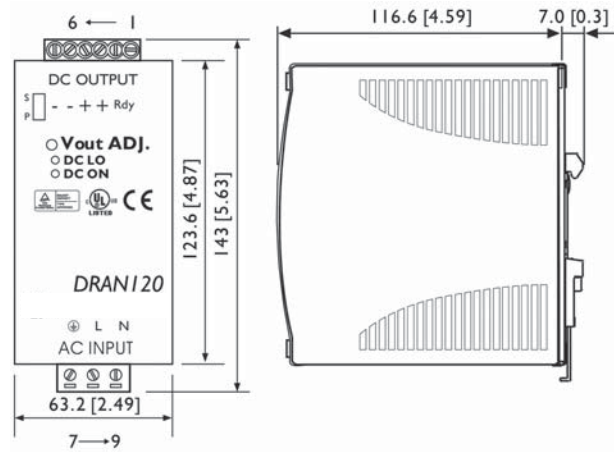

PIN assignment

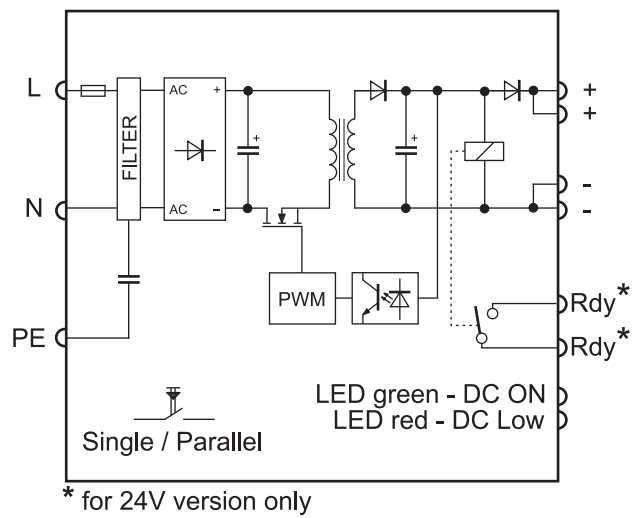

21.09.2012 – Subject to technical modification

Part-No. 722758

USA: LUTZE INC.

13330 South Ridge Drive • Charlotte, NC 28273, USA

Tel. +1 (704) 504-0222 • Fax +1 (704) 504-0223

www.lutze.com • info@lutze.com

United Kingdom: LÜTZE Ltd.

Unit 3, Sandy Hill Park

Sandy Way, Amington • GB-Tamworth, Staffs B77 4DU

Tel. +44 (0)1827 31333-0 • Fax +44 (0)1827 31333-2

www.lutze.com • sales.gb@lutze.co.uk



SYSTEMATIC TECHNOLOGY

Derating

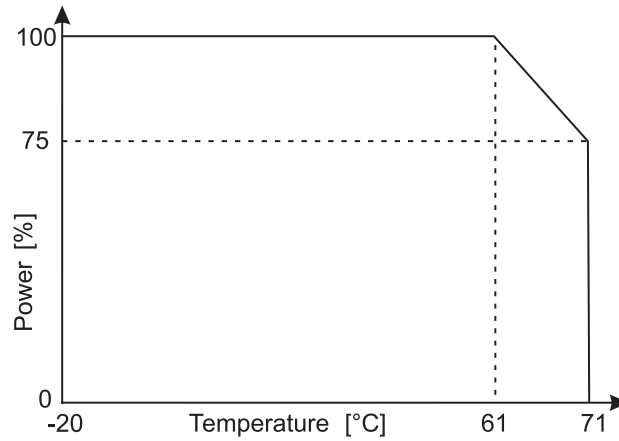

Parallel/redundant mode

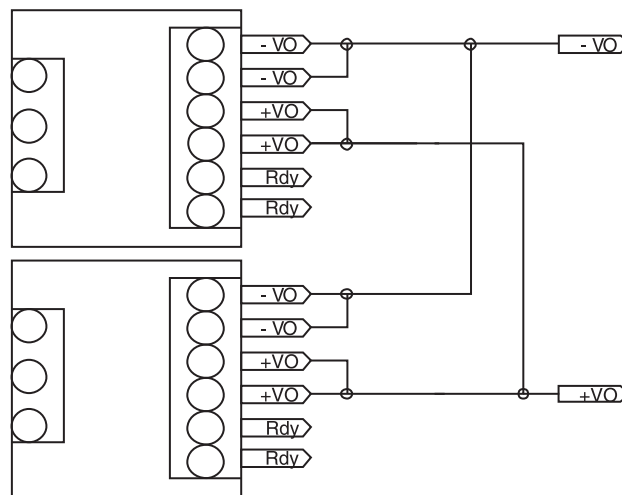

21.09.2012 – Subject to technical modification

Part-No. 722758

USA: LUTZE INC.

13330 South Ridge Drive • Charlotte, NC 28273, USA
Tel. +1 (704) 504-0222 • Fax +1 (704) 504-0223
www.lutze.com • info@lutze.com

United Kingdom: LÜTZE Ltd.

Unit 3, Sandy Hill Park
Sandy Way, Amington • GB-Tamworth, Staffs B77 4DU
Tel. +44 (0)1827 31333-0 • Fax +44 (0)1827 31333-2
www.lutze.com • sales.gb@lutze.co.uk



SYSTEMATIC TECHNOLOGY

Short circuit characteristics

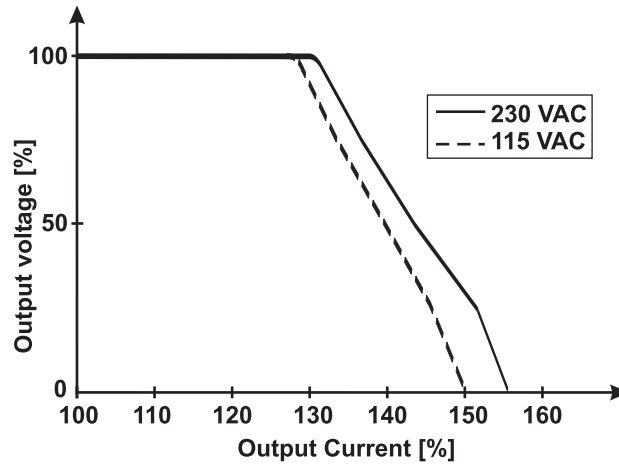

21.09.2012 – Subject to technical modification

Part-No. 722758

USA: LUTZE INC.

13330 South Ridge Drive • Charlotte, NC 28273, USA
Tel. +1 (704) 504-0222 • Fax +1 (704) 504-0223
www.lutze.com • info@lutze.com

United Kingdom: LÜTZE Ltd.

Unit 3, Sandy Hill Park
Sandy Way, Amington • GB-Tamworth, Staffs B77 4DU
Tel. +44 (0)1827 31333-0 • Fax +44 (0)1827 31333-2
www.lutze.com • sales.gb@lutze.co.uk



SYSTEMATIC TECHNOLOGY