

External Hinged Interfaces

AMPSEAL 16 Connector



Dimensional Data and Part Number Configuration

Part No.	Conduit Size (A)		Nominal Dimensions				Connector Reference
	NC	NW	B	C	D	E	
CI08-AT2PL	08	7.5	23	18	34	12	2 Way
CI08-AT3PL	08	7.5	28	18	33	11	3 Way
CI08-AT4PL	08	7.5	29	23	39	13	4 Way
CI12-AT4PL	12	10	29	23	37	11	4 Way
CI12-AT6PL	12	10	29	23	37	11	6 Way
CI12-AT8PL	12	10	32	23	37	11	8 Way
CI12-AT12PL	12	10	41	23	37	11	12 Way
CI16-AT8PL	16	13	32	23	37	11	8 Way
CI16-AT12PL	16	13	41	23	37	11	12 Way
CI20-AT20PL	20	17	41	23	48	12	20 Way

Note : Nominal Dimensions are in mm

LP = Low Profile back shell for AMPSEAL Plug,
 LR = Low Profile Back Shell for AMPSEAL Receptacle
 PL= Standard Profile Back Shell for AMPSEAL Plug

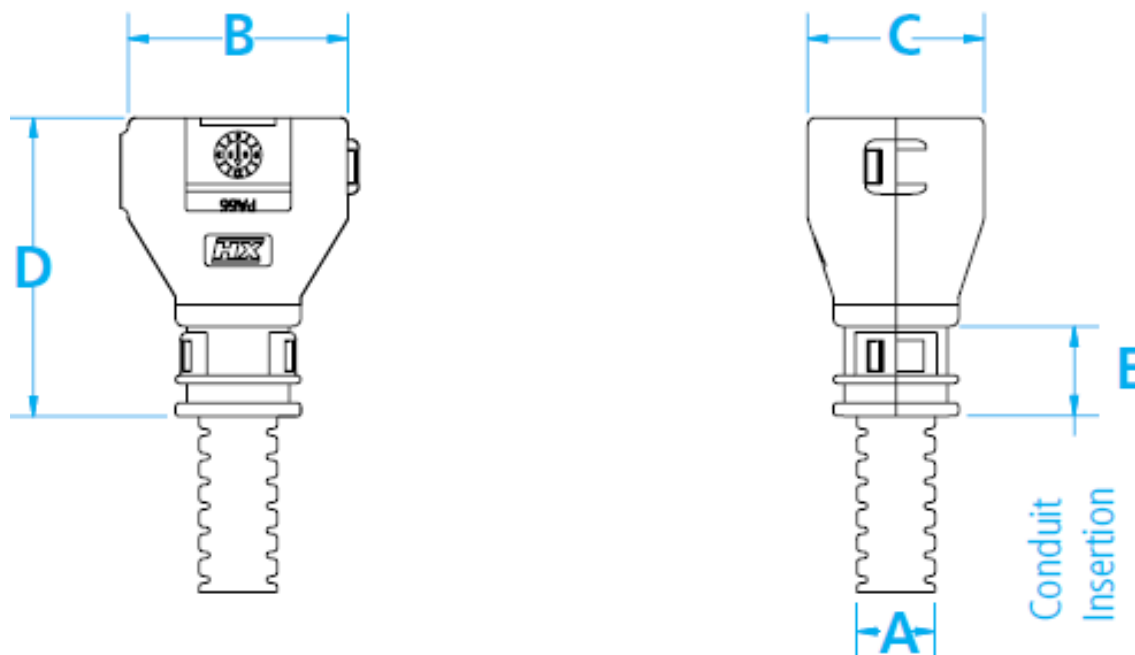

Cable Management Products Ltd.

CMG House - Station Road - Coleshill - B46 1HT - United Kingdom
 Tel: +44(0)1675 468 222 - Fax: +44(0)1675 464 930
 Technical Support e-mail: cmg.conduitsystems@tnb.com - www.harnessflex.com

External Hinged Interfaces

AMPSEAL 16 Connector



Dimensional Data and Part Number Configuration

Part No.	Conduit Size (A)		Nominal Dimensions				Connector Reference
	NC	NW	B	C	D	E	
CI08-90-AT2LP	08	7.5	37.3	25.0	17.0	7.1	2 Way
CI08-90-AT2LR	08	7.5	37.3	25.0	20.0	7.1	2 Way
CI08-90-AT3LP	08	7.5	39.8	29.0	17.1	7.1	3 Way
CI08-90-AT3LR	08	7.5	39.8	29.0	17.1	7.1	3 Way
CI08-90-AT4LP	08	7.5	40.8	29.4	20.6	7.1	4 Way
CI08-90-AT4LR	08	7.5	40.8	29.4	20.6	7.1	4 Way
CI08-90-AT6LP	08	7.5	42.8	29.4	22.5	7.1	6 Way
CI08-90-AT6LR	08	7.5	42.8	29.4	22.5	7.1	6 Way

Note : Nominal Dimensions are in mm

LP = Low Profile back shell for AMPSEAL Plug,
 LR = Low Profile Back Shell for AMPSEAL Receptacle
 PL= Standard Profile Back Shell for AMPSEAL Plug

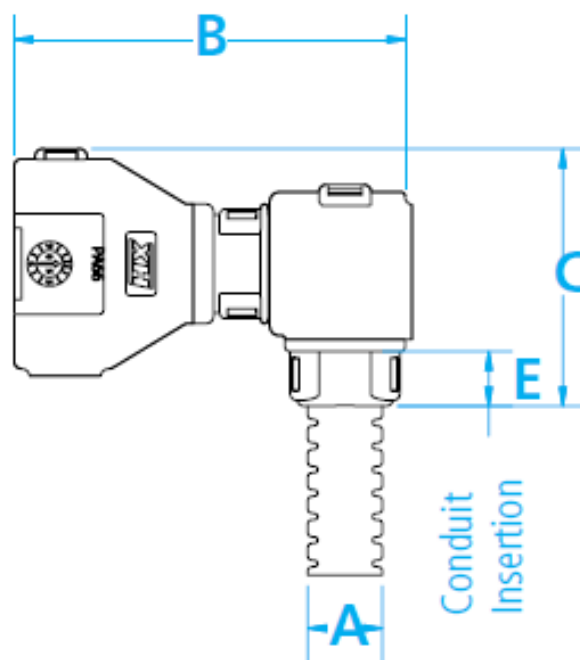
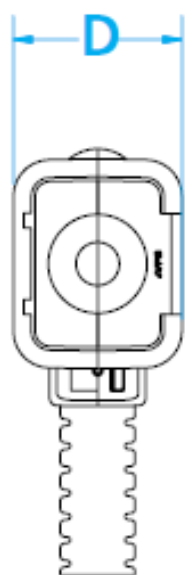

Cable Management Products Ltd.

CMG House - Station Road - Coleshill - B46 1HT - United Kingdom
 Tel: +44(0)1675 468 222 - Fax: +44(0)1675 464 930
 Technical Support e-mail: cmg.conduitsystems@tnb.com - www.harnessflex.com

External Hinged Interfaces

AMPSEAL 16 Connector



Dimensional Data and Part Number Configuration

Part No.	Conduit Size (A)		Nominal Dimensions				Connector Reference
	NC	NW	B	C	D	E	
CI12-90-AT2LP	12	10	38	23	20	7.1	2 Way
CI12-90-AT2LR	12	10	38	23	20	7.1	2 Way
CI12-90-AT3LP	12	10	40.2	27.1	17.1	7.1	3 Way
CI12-90-AT3LR	12	10	40.2	27.1	17.1	7.1	3 Way
CI12-90-AT4LP	12	10	41.1	27.5	20.6	7.1	4 Way
CI12-90-AT4LR	12	10	41.1	27.5	20.6	7.1	4 Way
CI12-90-AT6LP	12	10	43.1	27.5	22.5	7.1	6 Way
CI12-90-AT6LR	12	10	43.1	27.5	22.5	7.1	6 Way

Note : Nominal Dimensions are in mm

LP = Low Profile back shell for AMPSEAL Plug,
 LR = Low Profile Back Shell for AMPSEAL Receptacle
 PL= Standard Profile Back Shell for AMPSEAL Plug

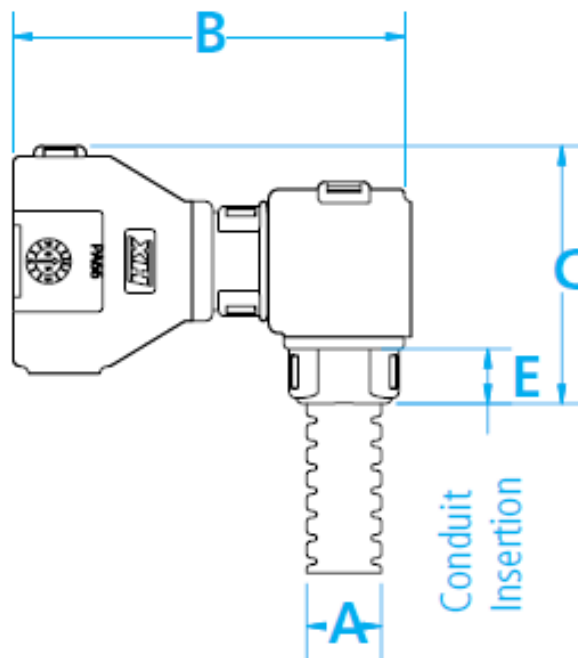
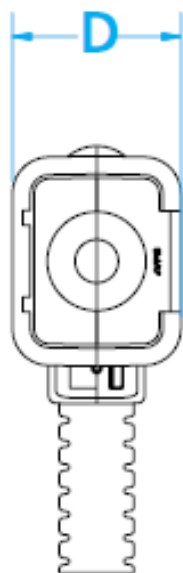

Cable Management Products Ltd.

CMG House - Station Road - Coleshill - B46 1HT - United Kingdom
 Tel: +44(0)1675 468 222 - Fax: +44(0)1675 464 930
 Technical Support e-mail: cmg.conduitsystems@tnb.com - www.harnessflex.com

External Hinged Interfaces

AMPSEAL 16 Connector



Dimensional Data and Part Number Configuration

Part No.	Conduit (A)		Nominal Dimensions				Connector Reference
	NC	NW	B	C	D	E	
CI08-90-AT2PL	08	7.5	49	32	20	7.1	2 Way
CI08-90-AT3PL	08	7.5	49	34	20	7.1	3 Way
CI08-90-AT4PL	08	7.5	53	34	23	7.1	4 Way
CI12-90-AT2PL	12	10	49	32	20	7.1	2 Way
CI12-90-AT3PL	12	10	49	34	20	7.1	3 Way
CI12-90-AT4PL	12	10	53	35	23	7.1	4 Way

Note : Nominal Dimensions are in mm

LP = Low Profile back shell for AMPSEAL Plug,
 LR = Low Profile Back Shell for AMPSEAL Receptacle
 PL= Standard Profile Back Shell for AMPSEAL Plug

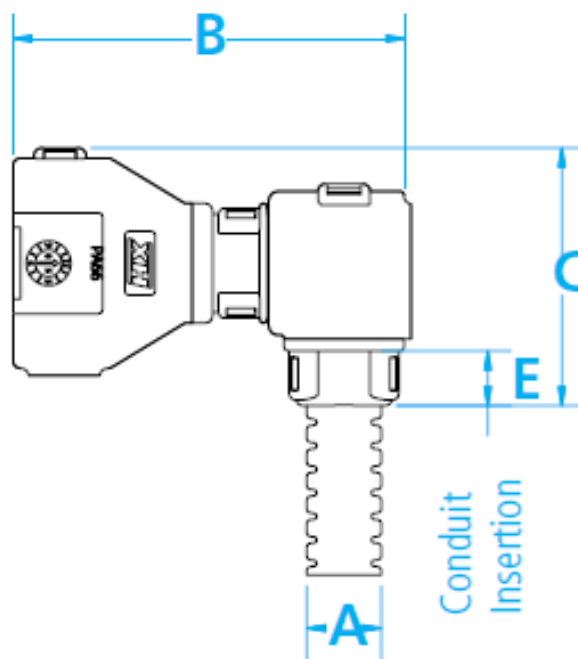
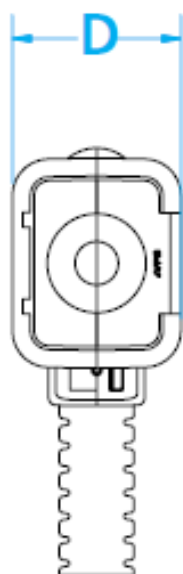

Cable Management Products Ltd.































































CMG House - Station Road - Coleshill - B46 1HT - United Kingdom
 Tel: +44(0)1675 468 222 - Fax: +44(0)1675 464 930
 Technical Support e-mail: cmg.conduitsystems@tnb.com - www.harnessflex.com

External Hinged Interfaces

AMPSEAL 16 Connector



Chemical Resistance Chart

Key: Suitable :  Limited Suitability :  Unsuitable :  Not Tested : 	 Astm No.1	 Diesel oil	 Methyl Bromide	 Sulphur Dioxide (Gas)
	 Astm No.2	 Diethylamine	 MEK	 Sulphuric Acid (10%)
	 Astm No.3	 Ethanol	 Nitric Acid (10%)	 Sulphuric Acid (70%)
	 Acetic Acid (10%)	 Ether	 Nitric Acid (70%)	 Toluene
	 Acetone	 Ethylamine	 Oxalic Acid	 Transformer Oil
	 Aluminium Chloride	 Ethylene Glycol	 Ozone (Gas)	 1,1,1-Trichloroethane
	 Aniline	 Ethyl Ethanoate	 Paraffin oil	 Trichloroethylene
	 Benzaldehyde	 Freon 32	 Petrol	 Turpentine
	 Benzene	 Hydrochloric Acid (10%)	 Phenol	 Vegetable Oil
	 Carbon tetrachloride	 Hydrochloric Acid (36%)	 Sea Water	 Vinyl Acetate
	 Chlorine water	 Hydrogen Peroxide (35%)	 Silver Nitrate	 Water
	 Chloroform	 Hydrogen Peroxide (87%)	 Skydrol	 White Spirit
	 Citric Acid	 Lactic Acid	 Sodium Chloride	 Zinc Chloride
	 Copper Sulphate	 Lubricating oil	 Sodium Hydroxide (10%)	
	 Cresol	 Methanol	 Sodium Hydroxide (60%)	

The information above is given as a guide only and is based on published technical data and experience. The chemical resistance of the above products is dependant on factors such as chemical exposure, concentration of the chemical and temperature. The above chemicals are valid for a temperature of 23°C. Use of the above table is at the users own discretion and risk. Those using it must satisfy themselves that their application presents no health and safety risks. The end user should assess compatibility with their application and contact Thomas & Betts for further information.

ADHERENCE TO THE CURRENT WIRING REGULATIONS BS7671 OR NEC WIRING REGULATIONS (FOR USA) IS STRONGLY ADVISED.

MINIMUM BEND RADIUS FOR FLEXING IS DEPENDANT UPON MINIMUM TEMPERATURE, BENDING FREQUENCY AND CHEMICAL ENVIRONMENT.

Storage Guidelines

To maintain balanced moisture content, Harnessflex recommends storing products under the following conditions:

Storage temp.	Installation temp.	Rel. humidity
18°C to 30°C	>18°C	>30%

If products from an outside environment are brought into a heated processing area, the change in climate may suddenly cause temporary de-moisturisation around the edges. After 24 hours in the processing area a natural balance will be restored.

Observing this storage recommendation ensures optimum process-ability and material properties.