

REV.	REVISION HISTORY	DATE
0	INITIAL RELEASE FOR QUOTE	JUL-24-2009
1	Add P/N	OCT-20-2014

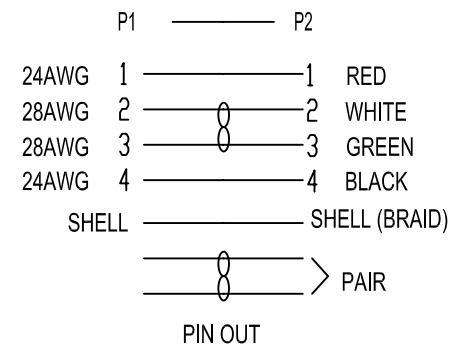

P/N CHART				
	1019217	8.196	2.5	2500
	LABEL	FT	M	L
P/N				+50/-50

MANUFACTURED IN CHINA

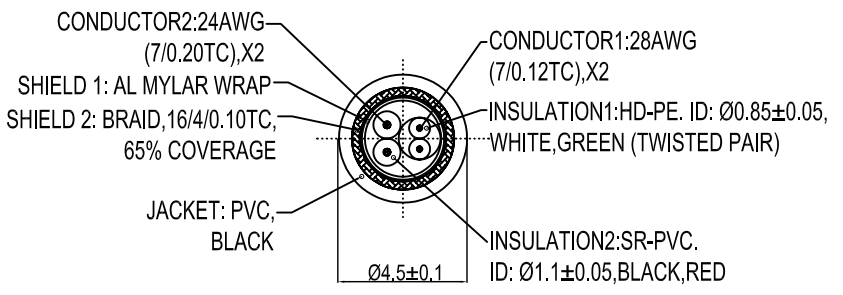
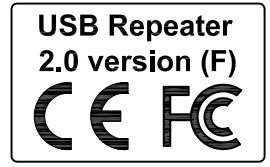
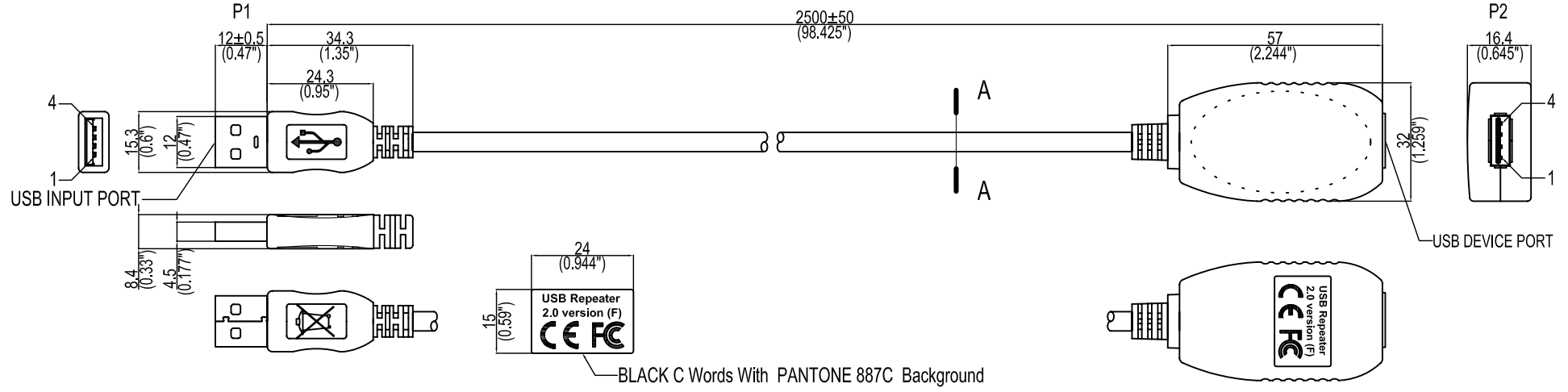



DRAWING APPROVED			
<small>IMPORTANT! A CONFIRMATION OF THE INFORMATION CONTAINED IN THIS DRAWING IS THE SOLE RESPONSIBILITY OF CABLES TO GO. ANY REPRODUCTION IN PART OR AS A WHOLE WITHOUT THE WRITTEN PERMISSION OF CABLES TO GO IS PROHIBITED.</small>			
	TITLE USB 2.0 2.5M Active Extension Cable	ENG. DATE	
SCALE NONE	CUS. NAME	CHECKED DATE	
SHEET 1/3	CUS. P/N 1019217	APPROVED DATE	
<small>UNLESS OTHERWISE NOTED</small> X ± = 0.5 (0.020") Y ± = 0.050 (0.001")	ANGLES ±	DWG. NO.	
REV.	CUS. REV.	DATE	

REV.	REVISION HISTORY	DATE
0	INITIAL RELEASE FOR QUOTE	JUL-24-2009
1	Add P/N	OCT-20-2014

NOTES:

1. ALL DIMENSIONS ARE IN MILLIMETERS(INCH).
2. PRODUCT IS CE MARKED AND CONFORMS TO 2011/65/EU ROHS 2.
3. MATERIAL:
 - P1: PVC. COLOR: BLACK.
 - P2: HOUSING, ABS. COLOR: TRANSLUCENT BLACK.
4. CONNECTOR:
 - P1: USB 2.0 A TYPE MALE, SOLDER TYPE, WHITE PBT INSULATION, GOLD PLATED 30u" CONTACTS, NICKEL PLATED SHELL
 - P2: USB 2.0 A TYPE FEMALE, PCB 90° TYPE, WHITE PBT INSULATION, GOLD PLATED 30u" CONTACTS, NICKEL PLATED SHELL
5. CABEL MARKING:
 - E338413 AWM STYLE 2725 80°C 30V VW-1 USB 2.0
 - E253299 AWM STYLE 2725 80°C 30V VW-1 USB 2.0
6. OPERATION TEM: -5°C TO +55°C; 5~95% RH(NON-CONDITINING)
7. STORAGE TEMP: -10°C TO +85°C; 5~95% RH(NON-CONDITINING)
8. QC INSPECTION:
 - 8.1 CHECK PRODUCT OPERATION FUNCTIONALITY
 - 8.2 ELECTRICAL TEST VERIFICATION
 - 8.3 CHECK ALL ACCESSORIES INCLUDED

REACH TEST REPORT		
Test Item	Method	MDL(mg/kg)
DBP	Withreference to EN14372:2004.AnylyzedbyGCMS.	30
BBP	Withreference to EN14372:2004.AnylyzedbyGCMS.	30
DEHP	Withreference to EN14372:2004.AnylyzedbyGCMS.	30

DRAWING APPROVED			
<small>PROPRIETARY & CONFIDENTIAL. THE INFORMATION CONTAINED IN THIS DRAWING IS THE SOLE PROPERTY OF CABLES TO GO. ANY REPRODUCTION IN PART OR AS A WHOLE WITHOUT THE WRITTEN PERMISSION OF CABLES TO GO IS PROHIBITED.</small>			
	mm	TITLE	 GET CONNECTED
SCALE	NONE	USB 2.0 2.5M Active Extension Cable	
SHEET	2/3	CUS. NAME	ENG. DATE
<input type="checkbox"/> <small>INDUSTRIAL TELEPHONES UNLESS OTHERWISE NOTED</small>		CUS. P/N	CHECKED DATE
<input type="checkbox"/> <small>REV.</small>	$X \pm = 0.5 (0.020")$ $XX \pm = 0.100 (0.03")$ $XXX \pm = 0.050 (0.001")$	1019217	APPROVED DATE
	<small>ANGLES ±</small>	DWG. NO.	
	<small>CUS. REV.</small>		

REV.	REVISION HISTORY	DATE
0	INITIAL RELEASE FOR QUOTE	JUL-24-2009
1	Add P/N	OCT-20-2014

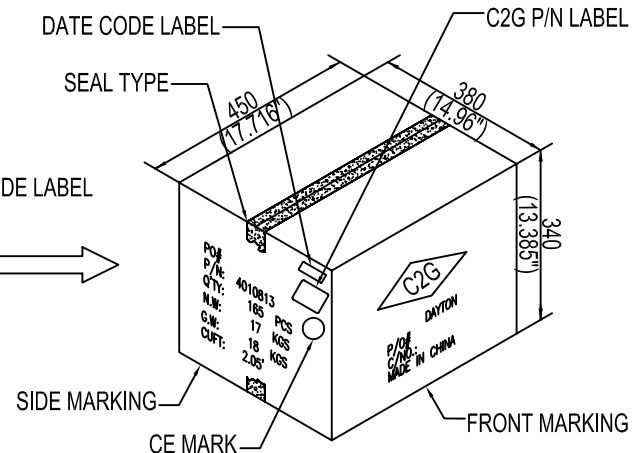
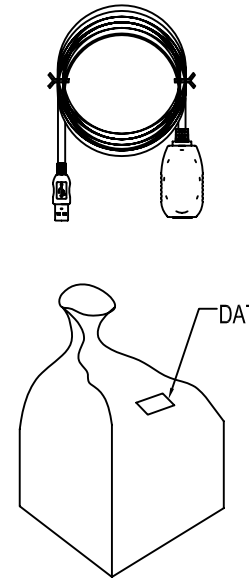
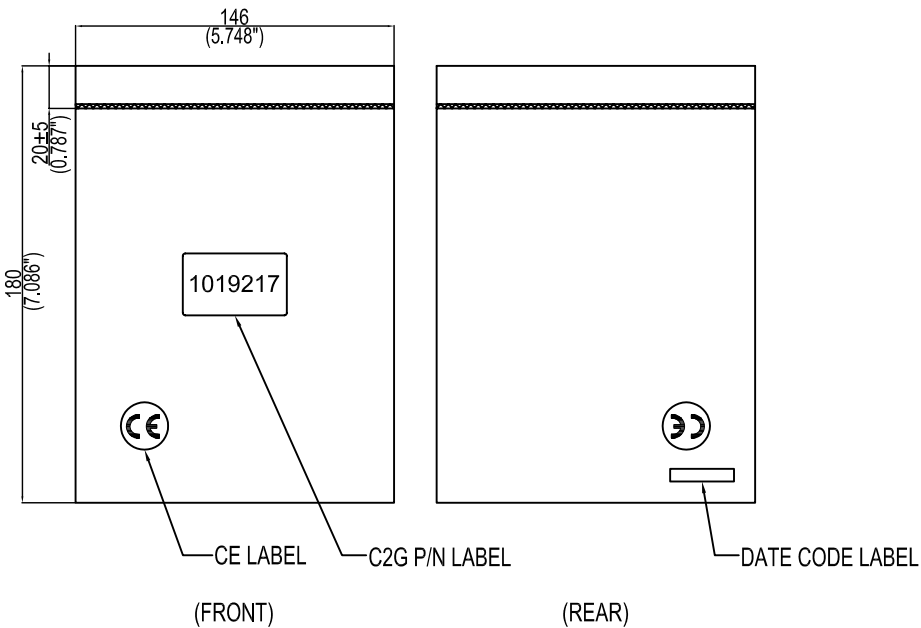

CARTON MARKINGS

SIDE MARKING	FRONT MARKING
PD# P/N: 4010813 Q'TY: 165 PCS N.W.: 17 KGS G.W.: 18 KGS CUFT: 2.05'	 DAYTON P/O# C/NO.: MADE IN CHINA

C2G P/N LABEL

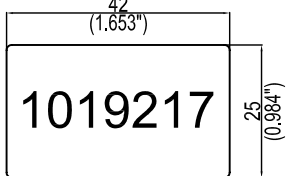

DATE CODE LABEL

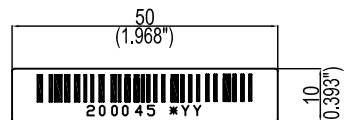

CE LABEL

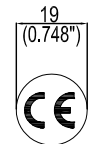

- PACKING CONTENTS:
- (1)PE BAG(7.086**5.748**0.002")
 - (2)C2G P/N LABEL(1.635**0.984")
 - (3)C2G CE LABEL
 - (4)DATE CODE LABEL
 - (5)MASTER CARTON

YEAR, 11=2011, 12=2012...
 MONTH, A=JAN, B=FEB...
 SUPPLIER ID(LH=20045)

DRAWING APPROVED

<small>PROPRIETARY & CONFIDENTIAL. THE INFORMATION CONTAINED IN THIS DRAWING IS THE SOLE PROPERTY OF CABLES TO GO. ANY REPRODUCTION IN PART OR AS A WHOLE WITHOUT THE WRITTEN PERMISSION OF CABLES TO GO IS PROHIBITED.</small>		 <small>GET CONNECTED</small>
<small>TITLE</small> USB 2.0 2.5M Active Extension Cable	<small>CUS. NAME</small> 1019217	
<small>SCALE</small> NTS	<small>CUS. P/N</small> 1019217	<small>ENG.</small> DATE
<small>SHEET</small> 3/3	<small>DWG. NO.</small> 1019217	<small>CHECKED</small> DATE
<small>APPROVED</small> DATE	<small>APPROVED</small> DATE	<small>APPROVED</small> DATE

P/N	180*146*0.06(7.086**5.748**0.002")	450*380*340(17.716**14.96**13.385)	165
	PE BAG SIZE	CARTON SIZE	CARTON Q'TY