

# Cable Ladders

## Ladder Sections

CUSTOM WIDTHS AND RUNG PLACEMENT AVAILABLE. CALL FOR DETAILS.

A complete line of 12", 18", and 24" wide, fully welded cable ladders. Cable ladder sections ship fully boxed, which minimizes product damage and simplifies shipping and storage. Highly durable finish consists of 2 layers of black powder coat and is exceptionally scratch resistant. Compatible with most popular brands and accessories of cable ladders, these will work on both new and retrofit installations.



EIA/TIA Compliant



Spec. # 96-986  
A&E  
for full product info.

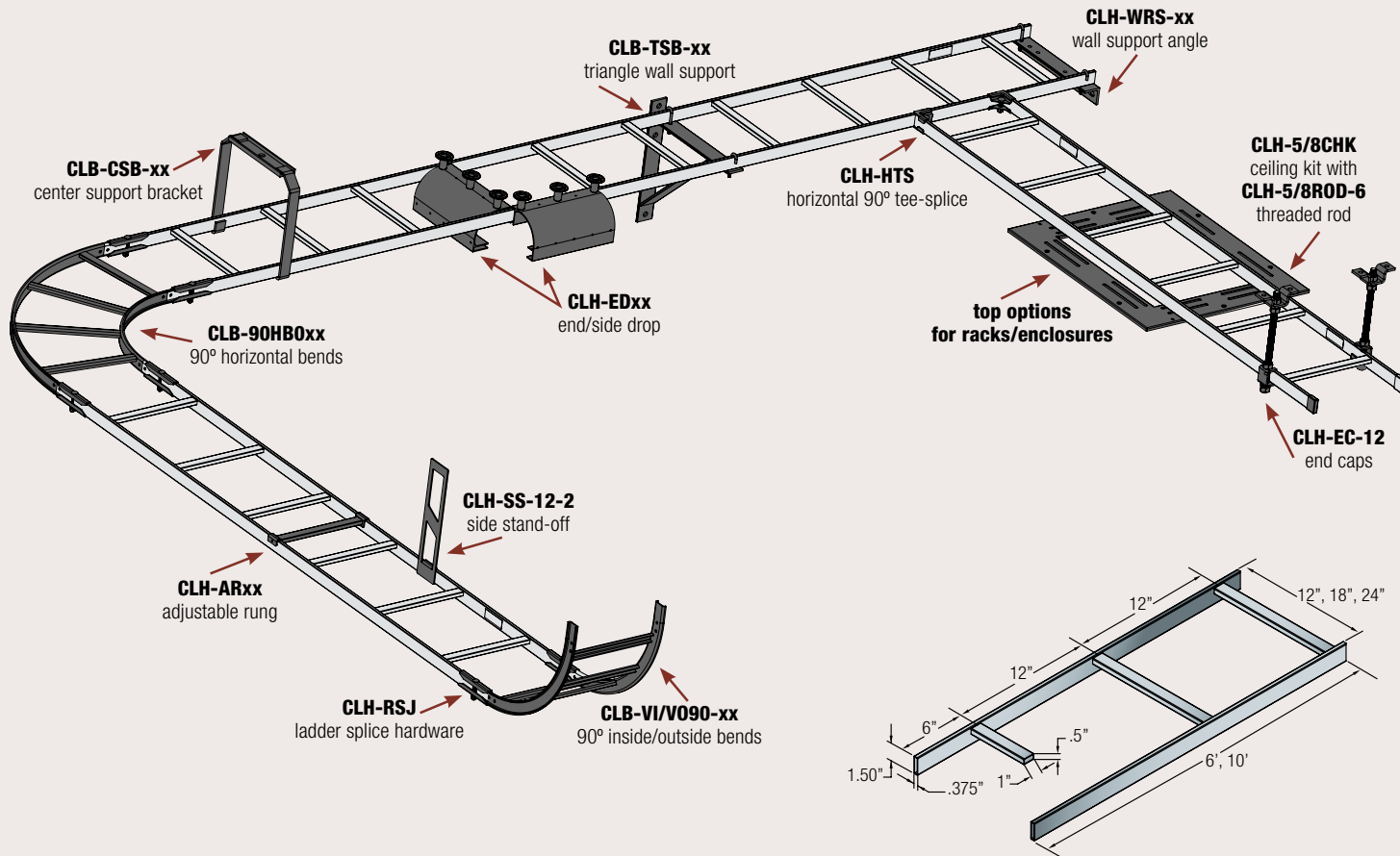

12" Wide Bulk Packs	12" Wide Part #	18" Wide Part #	24" Wide Part #	Description
CLB-6-12 (12 pieces)	CLB-6	CLB-6-W18	CLB-6-W24	6' long straight ladder section, black
CLB-10-12 (12 pieces)	CLB-10	CLB-10-W18	CLB-10-W24	10' long straight ladder section, black
CLB-90HB-4 (4 pieces)	CLB-90HB	CLB-90HB-W18	CLB-90HB-W24	90° horizontal bend, black
CLB-VI90-4 (4 pieces)	CLB-VI90	CLB-VI90-W18	CLB-VI90-W24	90° vertical inside bend, black
CLB-V090-4 (4 pieces)	CLB-V090	CLB-V090-W18	CLB-V090-W24	90° vertical outside bend, black

## Junction and Splice Hardware - All Hardware has Black Finish

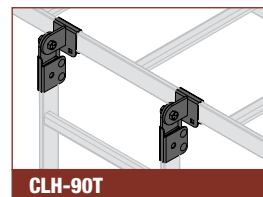
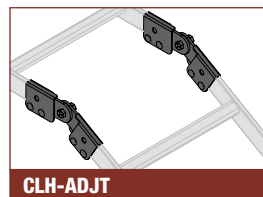
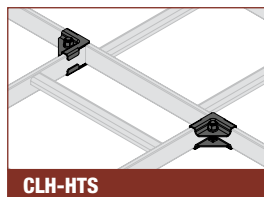
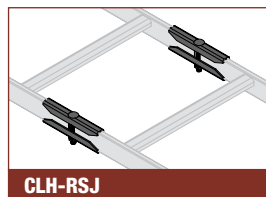
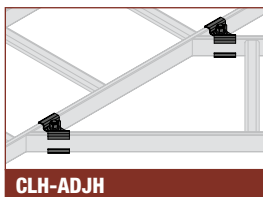

Part #	Qty	Description
CLH-ADJH	1 pair	adjustable horizontal splice hardware
CLH-ADJH-6	6 pairs	adjustable horizontal splice hardware
CLH-RSJ	1 pair	ladder end splice hardware
CLH-RSJ-6	6 pairs	ladder end splice hardware
CLH-HTS	1 pair	horizontal 90° tee splice hardware

Part #	Qty	Description
CLH-HTS-6	6 pairs	horizontal 90° tee splice hardware
CLH-ADJT	1 pair	adjustable ladder end splice hardware
CLH-ADJT-6	6 pairs	adjustable ladder end splice hardware
CLH-90T	1 pair	adjustable 90° tee splice hardware
CLH-90T-6	6 pairs	adjustable 90° tee splice hardware



# Cable Ladders

## Wall/Ceiling Mounts - All Hardware has Black Finish

CUSTOM WIDTHS AND RUNG PLACEMENT AVAILABLE. CALL FOR DETAILS.

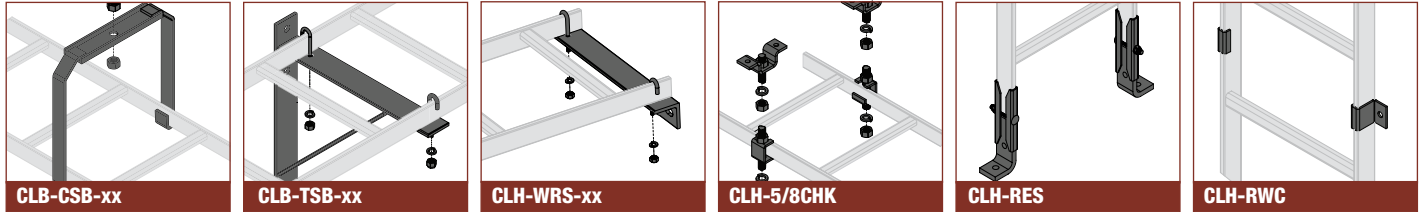

12" Wide (Bulk 6 Pack)	12" Wide Part #	18" Wide Part #	24" Wide Part #	Description
CLB-CSB-6	CLB-CSB	CLB-CSB-W18	CLB-CSB-W24	center support bracket
CLB-TSB-6	CLB-TSB	CLB-TSB-W18	CLB-TSB-W24	triangle wall support bracket
CLH-WRS-6	CLH-WRS or CLH-WRS-W6-W12	CLH-WRS-W18-W24	CLH-WRS-W18-W24	ladder wall support angle
CLH-5/8CHK-6		CLH-5/8CHK		5/8" slotted ceiling kit, fits all widths
-		CLH-5/8ROD-12-4		12" long section 5/8" threaded rod, 4 pieces
-		CLH-5/8ROD-6		6" long section 5/8" threaded rod, 1 piece
CLH-RES-6		CLH-RES		ladder end support hardware, fits all widths
CLH-RWC-6		CLH-RWC		ladder wall clamp, fits all widths

## Side, End Drops and Adjustable Rungs

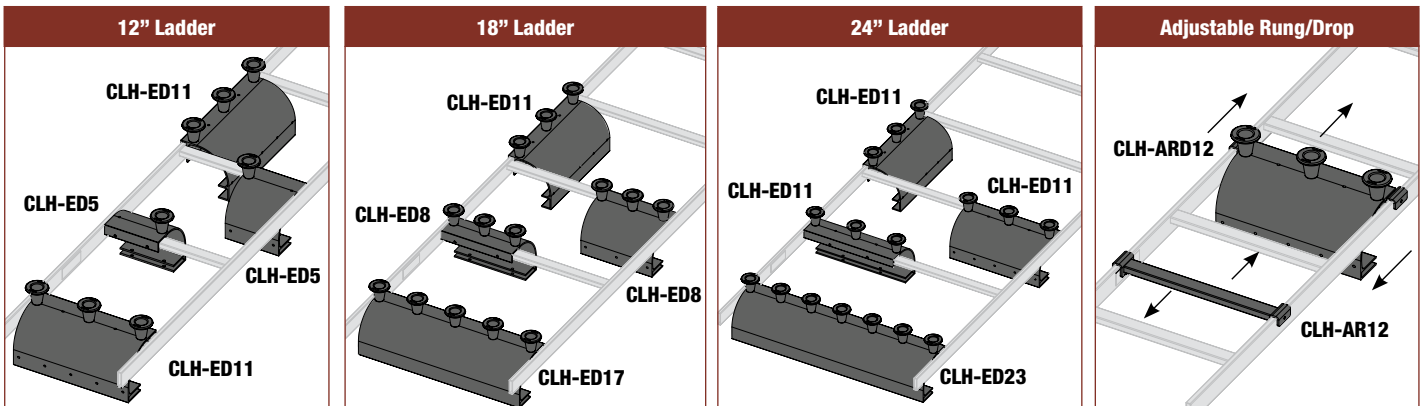

12" Wide (Bulk 4 Pack)	12" Wide Part #	18" Wide Part #	24" Wide Part #	Description
-	CLH-AR12	CLH-AR18	CLH-AR24	adjustable rung (no drop)
-	CLH-ARD12	CLH-ARD18	CLB-ARD24	adjustable rung drop with spools
CLH-ED11-4	CLH-ED11	CLH-ED17	CLH-ED23	end drop with spools
-		CLH-ED5		5" wide end drop with spools, fits all widths
-		CLH-ED8		8" wide end drop with spools, fits all widths
CLH-SD8-4		CLH-SD8		8" wide side drop with spools, fits all widths

## Accessories

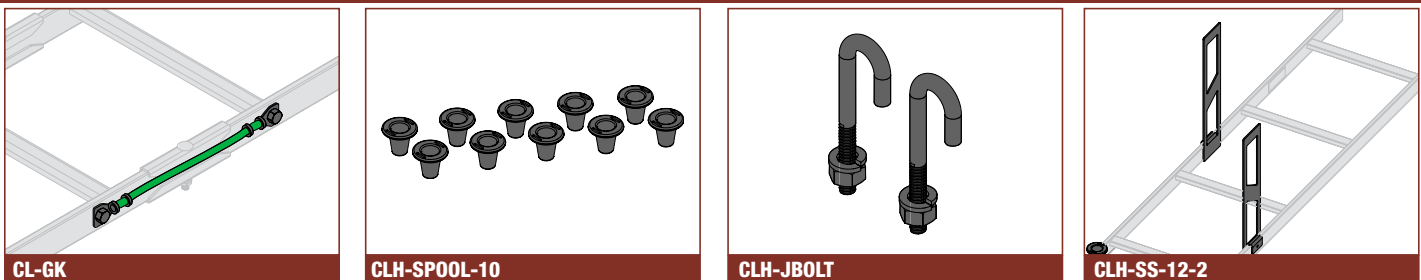

Part #	Description	Part #	Description
CL-GK	cable ladder bonding kit	CLH-5/8ROD-6	6' long section 5/8" threaded rod, 1 piece
CLH-EC-12	cable ladder end caps (12 pieces)	CLH-SS-12-2	12" high, side stand-off, 2 pieces
CLH-JBOLT	5/16" J-bolts and nuts (1 pair)	MK-LA	ladder adapter kit for MK-19-45-RL & RLA Series racks
CLH-SPOOL-10	cable management spools (10 pieces)	MW-LA	top option for DRK, MRK, WRK, VRK and VMRK Series enclosures
CLH-5/8ROD-12-4	12" long section 5/8" threaded rod, 4 pieces		

