

# Avenue System Overview

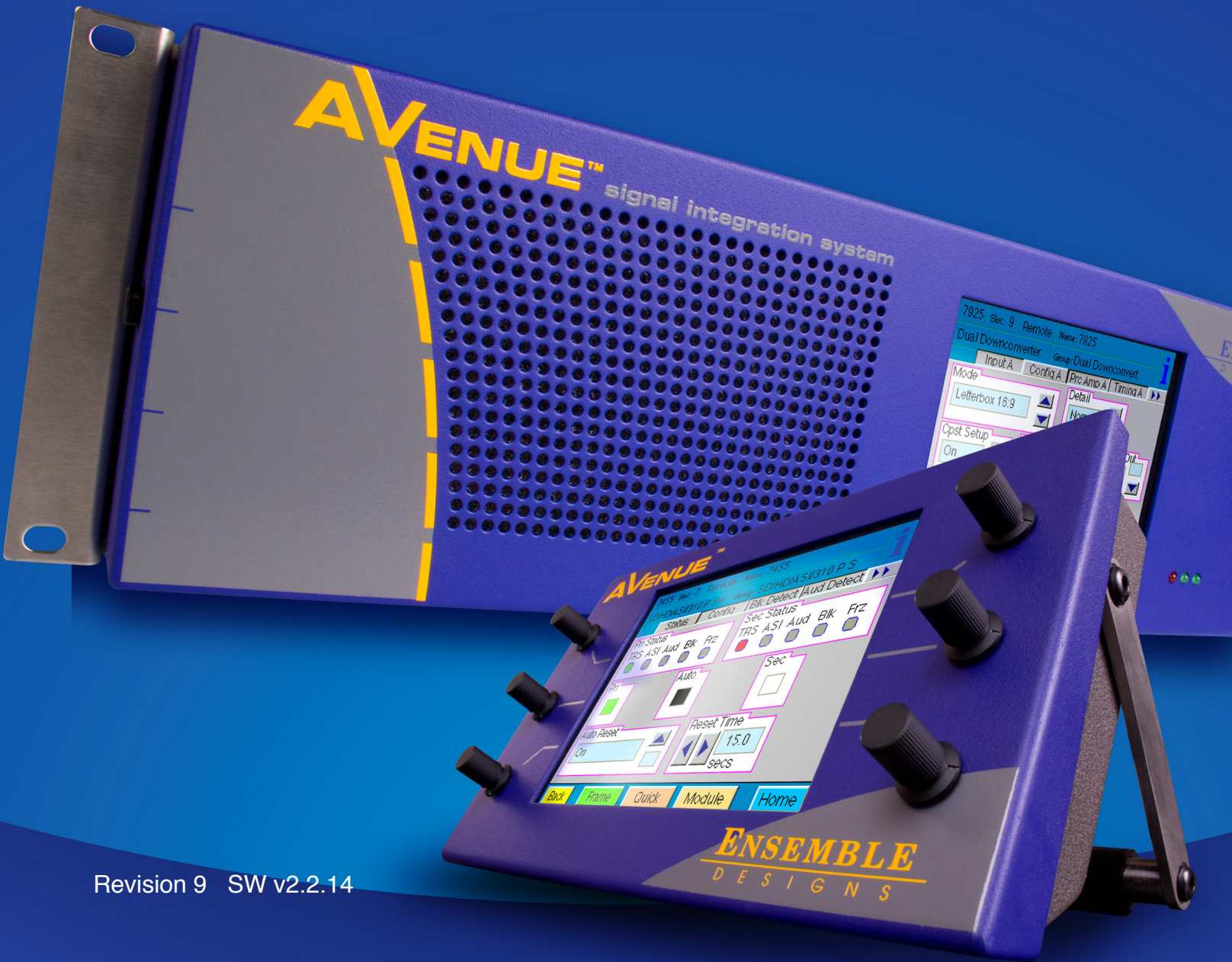

Revision 9 SW v2.2.14

# ENSEMBLE

---

D E S I G N S

*Purveyors of Fine Video Gear—Loved by Engineers Worldwide*

Clearly, Ensemble wants to be in the broadcast equipment business. It's so rare anymore to find a company of this caliber that has not been gobbled up by a large corporation. They are privately held so they don't have to please the money people. They really put their efforts into building products and working with customers.

I'm really happy with the Avenue products and Ensemble's service, and even more important my engineers are happy. We've continued to upgrade the product and add more cards. We will be rebuilding our production control room and we will use Avenue again.

~ Don McKay, Vice President Engineering, Oregon Public Broadcasting

## Who is Ensemble Designs?

### By Engineers, For Engineers

In 1989, a former television station engineer who loved designing and building video equipment, decided to start a new company. He relished the idea of taking an existing group of equipment and adding a few special pieces in order to create an even more elegant ensemble. So, he designed and built his first product and the company was born.



Avenue frames handle 270 Mb/s, 1.5 Gb/s and 3 Gb/s signals, audio and MPEG signals. Used worldwide in broadcast, mobile, production, and post.

### Focused On What You Need

As the company has grown, more former TV station engineers have joined Ensemble Designs and this wealth of practical experience fuels the company's innovation. Everyone at the company is focused on providing the very equipment you need to complete your ensemble of video and audio gear. We offer those special pieces that tie everything together so that when combined, the whole ensemble is exactly what you need.

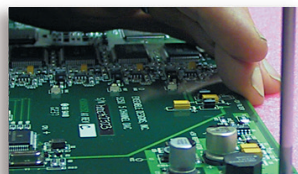

We're focused on processing gear— 3G/HD/SD/ASI video, audio and optical modules.

### Notably Great Service for You

We listen to you – just tell us what you need and we'll do our best to build it. We are completely focused on you and the equipment you need. Being privately held means we don't have to worry about a big board of directors or anything else that might take attention away from real business. And, you can be sure that when you call a real person will answer the phone. We love this business and we're here to stay.



Come on by and visit us. Drop in for lunch and a tour!

### Bricks and Mortar of Your Facility

The bricks and mortar of a facility include pieces like up/downconverters, audio embedders, video converters, routers, protection switches and SPGs for SD, HD and 3Gb/s. That's what we're focused on, that's all we do – we make proven and reliable signal processing and infrastructure gear for broadcasters worldwide, for you.



Shipped with care to television broadcasters and video facilities all over the world.



## Contents

<b>Chapter 1: Avenue System Description</b>	<b>6</b>
<b>Introduction</b>	<b>6</b>
<b>Avenue Frames and Modules</b>	<b>7</b>
Avenue 1RU Frame	7
Avenue 3RU Frame	8
<b>Video and Audio Modules</b>	<b>9</b>
<b>5010 Power Supply</b>	<b>10</b>
<b>5020 Power Supply</b>	<b>10</b>
<b>5030/5035 System Control Modules</b>	<b>11</b>
<b>Avenue Control System</b>	<b>12</b>
Avenue PC Software	12
Virtual Modules	12
Alarms	12
User Levels	12
Free Software Updates	12
<b>Chapter 2: Installation</b>	<b>13</b>
<b>Frame Installation</b>	<b>13</b>
<b>Module Installation</b>	<b>14</b>
1RU Frame	14
3RU Frame	15
<b>Avenue Touch Screen Installation</b>	<b>17</b>
Touch Screen Front Panel Installation	17
Tabletop Touch Screen Installation	17
<b>Chapter 3: Cabling</b>	<b>19</b>
<b>Frame Cabling</b>	<b>19</b>
Video Connections	19
Control Connections	20
<b>Tabletop Control Panel Cabling</b>	<b>22</b>

<b>Express Panel Cabling</b>	<b>22</b>
<b>Module Cabling</b>	<b>23</b>
<b>Chapter 4: Networking</b>	<b>24</b>
<b>Networking Prerequisites</b>	<b>24</b>
<b>Control Options</b>	<b>24</b>
Avenue Touch Screen Control Panels	24
Express Panel	24
Avenue PC Control Software	25
<b>Four Approaches to Networking Avenue Systems</b>	<b>25</b>
1. Ethernet Star Configuration	26
2: Ethernet Hub with AveNet Groups and Control Panels	27
3: Direct Connection of Two AveNet Groups Over IP	28
4: AveNet Interconnection Only	29
<b>Configuring Each Frame's System Control Module</b>	<b>30</b>
3RU Frames	30
1RU Frames	30
5030 and 5035 Front Panel Controls and Indicators	31
Control Module Configuration Menus	32
Enabling AVIP (AveNet over IP)	33
Setting the AveNet Address	33
Setting the AveNet Lower and Upper Addresses	34
Setting the IP Address	34
<b>Avenue Security Overview</b>	<b>39</b>
User Levels	39
Module Lock	40
<b>SNMP Monitoring</b>	<b>46</b>
Upgrading For SNMP Monitoring	46
SNMP Function Table	47

<b>Chapter 5: Operations</b>	<b>48</b>
<b>Local Operation</b>	<b>48</b>
<b>Avenue PC Operation</b>	<b>48</b>
<b>Avenue Express Panel Menus and Operation</b>	<b>48</b>
<b>Avenue Touch Screen Panel Menus and Operation</b>	<b>48</b>
Home Menu	49
Touch Screen Calibration and Adjustment	50
Select Frame/Module Menu	52
Virtual Modules	57
Configuration Menu	57
<b>Avenue Touch Screen Troubleshooting</b>	<b>60</b>
To Reset the Touch Screen on a 3RU Frame	60
To Reset the Touch Screen on a Tabletop Control Panel	60
<b>Specifications</b>	<b>61</b>
Avenue 1RU Frame with 5010 Power Supply	61
Avenue 3RU Frame with 5020 Power Supply	61
<b>Warranty</b>	<b>62</b>
<b>Factory Service</b>	<b>62</b>

# Chapter 1: Avenue System Description

## Introduction

This chapter provides an overall description of Avenue components available as part of the Avenue Signal Integration System.

The Avenue system includes modules for up/down/cross conversion, audio embedding, synchronization, video conversion, routing, noise reduction, protection switches, test signal generators and more. Avenue signal processing modules are used worldwide in broadcast, mobile, satellite, cable, worship and post production facilities. Avenue is a tray-based signal integration system housed in a 3RU or 1RU frame. Any combination of 1.5 Gb/s HD, 3 Gb/s HD, SD, MPEG, analog video and audio processing modules can be used together in the same frame. All modules are hot swappable. Because of the universal backplane, no special rear connectors are needed.

For facilities using both fiber and coaxial cables, Avenue provides a complete and simple solution. The Avenue Intersection frame is just 1RU and holds 10 optical modules. It can be used independently or tied to an Avenue 3RU frame.

Built-in networking lets you tie your Avenue system together, streamlining control and monitoring. All frames and modules in the system can be accessed from multiple locations in a facility, as well as from remote locations via the Internet. Comprehensive management and control is achieved by using any combination of Avenue Control Panels and/or Avenue PC software. Front edge/local controls are also available for each module.

## Avenue Frames and Modules

Two frames are available for the Avenue system: 1RU and 3RU. Both frames handle nearly any mix of hot-swappable video and audio modules.

### Avenue 1RU Frame

Each Avenue 1RU frame can house a broad mix of three audio or video modules. However, when a 5035 System Control module is installed, the following modules cannot be installed in slot 3 of a 1RU frame:

- 4450
- 4455
- 7400
- 7420
- 7435
- 7450
- 7455
- 7465
- 9400
- P9425
- 9430
- 9440
- 9455
- 9465
- 9950

Video and audio modules for conversion, distribution and synchronization plug into a universal frame motherboard. No separate rear connector cards are needed. Plastic overlays for each module type are provided and slip over the corresponding BNCs on the backplane to identify the input and output designations on each type of module.

In addition to the three audio or video modules, the optional 5035 System Control module adds the capability to distribute a master timing reference to each module in the frame. It also allows for ethernet and serial interface to the frame and is required for remote control from one of the Avenue remote control options. Any number of frames with System Control modules installed can be networked and controlled together via Ethernet and/or AveNet.

You can have complete control over configuration of module parameters and monitoring from any location in your facility using one of the Avenue remote control options. These include the stand alone Tabletop Touch Screen Control Panel, the Touch Screen Front panel installed in the 3RU frame and the Avenue PC Application Software.



*Avenue 1RU Frame Front*

## Avenue 3RU Frame

The 3RU frame is a full-featured chassis that accommodates any ten Avenue modules. In addition to the ten module slots, there is a dedicated slot for the optional 5030 System Control module. The Avenue 3RU (5.25 inches) frame fits in a standard 19-inch rack. Any number of frames may be stacked together in any combination. All critical components such as fuses, filter and fan are accessible from the front of the unit.

Video and audio modules for conversion, distribution and synchronization plug into a universal frame motherboard. No separate rear connector cards are needed. Plastic overlays for each module type are provided and slip over the corresponding BNCs on the backplane to identify the input and output designations on each type of module.

In addition to the ten audio and video modules, the optional 5030 System Control module adds the capability to distribute a master timing reference to each module in the frame. It also allows for ethernet and serial interface to the frame and is required for remote control from one of the Avenue remote control options. Any number of frames with System Control modules installed can be networked and controlled together via Ethernet and/or AveNet.

You can have complete control over configuration of module parameters and monitoring from any location in your facility using one of the Avenue remote control options. These include the stand alone Tabletop Touch Screen Control Panel, the Touch Screen Front panel installed in the 3RU frame and the Avenue PC Software application. Avenue 3RU frames are available with either a plain door or one with the optional Touch Screen Panel installed as shown in the figures below.

A fan in the front door of each 3RU frame provides the necessary cooling for the frame. The fan is temperature-sensitive and adjusts its speed accordingly. Should the fan fail, a red LED will light on the front panel. If using a remote control option, an alarm can be set to alert the user of fan failure.

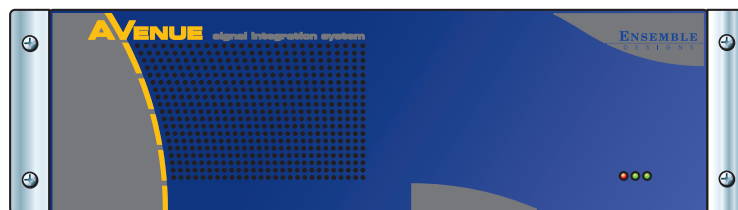

*Avenue 3RU Frame*

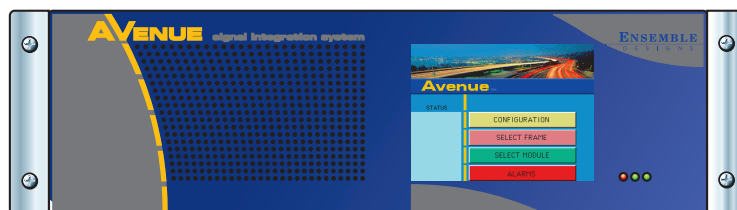

*Avenue 3RU Frame with Touch Screen*



## Video and Audio Modules

The Avenue modules available include the following types:

- Up/Down/Cross Converters
- Routers
- Mix Effects and Logo Inserters
- Multiviewers
- Protection and Clean Switches
- Sync Pulse and Test Signal Generators
- Audio Loudness and Compliance
- Audio and Dolby™ Embedding, Delay and Processing
- Audio Conversion, Distribution and Delay
- Video Conversion, Frame Syncs and Legalizers
- Proc Amps and Noise Reducers
- DVB-ASI Modules
- SMPTE 310M Modules
- Fiber Optic Modules
- Distribution Amplifiers
- GPI/Serial Interface Modules

New modules are being introduced all the time. To check for new modules as they become available, go to the the Ensemble Designs web site at [www.ensembledesigns.com](http://www.ensembledesigns.com).

Every module ships from the factory with the plastic overlay for its corresponding BNCs and a CD that contains PDFs of all the module manuals. Each module has a separate manual describing its installation, configuration and operation.

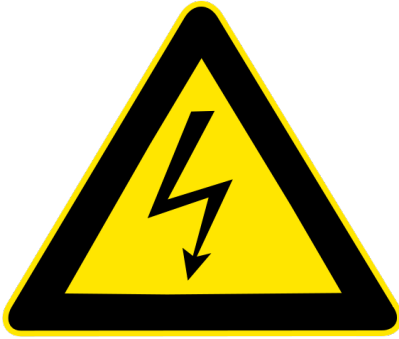

**Caution!**

Risk of electric shock. Qualified service personnel should only access power supply after frame has been unplugged from power.

This product may contain lasers. This is a Class A Laser Product. The optical output emits invisible radiation. Do not stare directly into the optical output beam or view directly with optical instruments.

## 5010 Power Supply

Each Avenue 1RU frame includes a single 5010 Power Supply module. It installs in the upper right slot of the frame. Power is provided to all modules in the frame where it is regulated to the required voltages for the module.

The Avenue 1RU frame uses an external in-line power supply. There is a single point of connection on the frame for power.

For customers who want a redundant power solution, Ensemble offers an external in-line dual power supply with two line cords. This optional power supply auto-switches.

## 5020 Power Supply

Each Avenue 3RU frame comes with one 5020 Power Supply module installed. An optional redundant power supply is available if desired to provide backup. Power is provided to all modules in the frame, the front door fan and optional Touch Screen Panel.

## 5030/5035 System Control Modules

The optional 5030/5035 System Control module provides the Ethernet, AveNet (our proprietary Local Area Network communication) and Serial interface connections required for networking, remotely configuring and controlling the frame modules from the Avenue remote control options. Ethernet can be used instead of, or in conjunction with, AveNet and Serial.

As shown below, the System Control module interfaces to the frame backplane for controlling the 10BaseT Ethernet TCP/IP connection, the AveNet LAN connection, and the serial communications port between frames. The System Control module is also used for distributing a master timing reference from the rear backplane BNC to all modules in a frame.

Any combination of Avenue equipment including 3RU frames, 1RU frames, Router Panels, Touch Screen Panels and Intersection frames can be used together on a network.

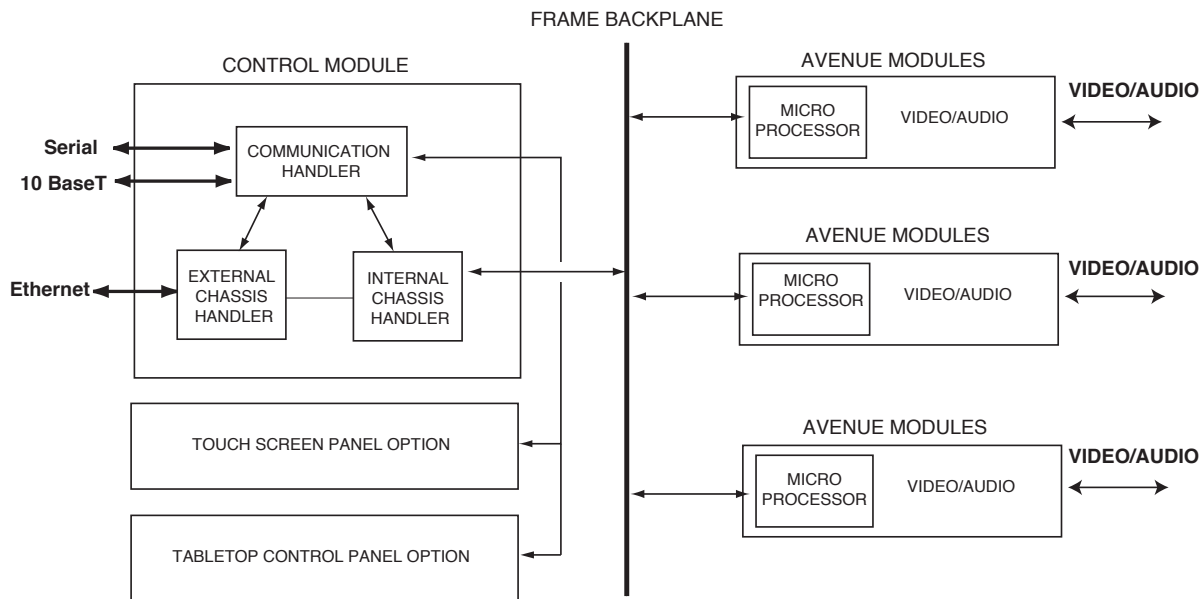

Control System Block Diagram

## **Avenue Control System**

### **Avenue PC Software**

Using Avenue PC Software, modules can be controlled and configured remotely. Any number of frames may be linked together and controlled by a PC running the Avenue software, even from remote locations via the Internet. The number of control points is expandable to suit the needs of the facility. Our protocol is also available for interfacing to automation and other third-party control systems.

### **Virtual Modules**

You can create custom menus for Avenue PC and Touch Screens that combine functionality from any modules in the system. A custom menu could include controls from several different modules, such as an embedder module, a video converter module and an audio delay module. Alternately, a custom menu could include a subset of controls from one module. You can design module menus and parameters to suit your needs. Custom menus are authored using Avenue PC and downloaded to any control point on the network.

### **Alarms**

Alarms can be created using Avenue PC. The Alarm menu offers choices specific to the module or frame you want to monitor. For example, you can set an alarm for loss of reference to a particular module or for power failure in a particular frame. If an alarm occurs, you can choose to have a log entry generated, an alarm sound on your PC, an email sent out, or even a page sent.

### **User Levels**

Touch Screens, the Express Panel, and Avenue PC have four user levels: Admin, Level1, Level2, and View Only. User levels can be protected by a four-digit pass code allowing level access to be assigned to different functional groups within your facility. Some groups may need more expert level access to certain parameters while others require read-only access. Critical modules can also be locked out entirely or set so only a single control point has access.

### **Free Software Updates**

Software updates for modules are posted on the following page on the Ensemble Designs web site:

<http://www.ensembledesigns.com/support/>

Updates are available to customers at no charge. After downloading the software, use Avenue PC to upload the new software into a module. The latest version is always available to you.

## Chapter 2: Installation

This chapter provides installation instructions for all Avenue hardware components including frames, modules and Touch Screens. Avenue PC installation is covered in the manual that accompanies the software.

### Frame Installation

The Avenue 1RU (1.75 inches) and 3RU (5.25 inches) frames fit in a standard 19-inch rack. Any number of frames may be stacked together, if desired, as illustrated in the figure at right.

A fan in the front door of each 3RU frame provides the necessary cooling for the frame. The fan is temperature-sensitive and adjusts its speed accordingly. Should the fan fail, a red LED will light on the front panel. If using a remote control option, an alarm can be set to alert the user of fan failure. All critical components such as fuses, filter and fan are accessible from the front of the unit.

The frame temperature is reported in degrees centigrade and the percentage of fan capacity being used is given in the Frame Controller Information Touch Screen menu (described in the Operation section of this manual). When using Avenue PC, the temperature and amount of fan capacity being used is reported in Frame Configuration under the Frame pulldown. When no Control module is present, the fan runs at full speed.

Should the frame temperature become too high (above 45 degrees C), a red LED will light on the front panel. If using a remote control option, an alarm can be set to alert the user of an overheating condition.

The power supplies are auto-switching and no setting is necessary for selecting line voltages. Power supplies are hot-swappable.

The fuses for the power supplies are located on the front of each supply and can be accessed from the front of the frame. Green LEDs on the front panel indicate status of the power supplies.

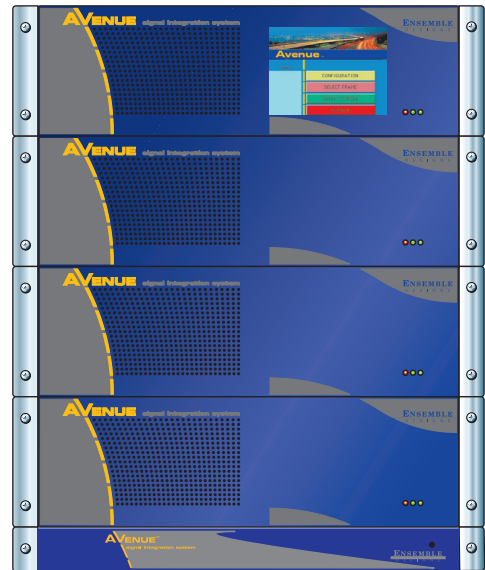

Front and rear rack ear kits are provided with the 1RU for mounting the frame. Front rack ears are installed on the 3RU frames at the factory and a rear rack ear kit is supplied with each frame.

To install the rack ears on either the 1RU or 3RU frames, locate the rear rack ear kits included with each frame. Each rear rack ear kit provides two rear rack ears and two slotted support tongues and screws for installation. Each frame has two holes on either side of the frame for installing the rear mounting hardware as shown in the illustration below.

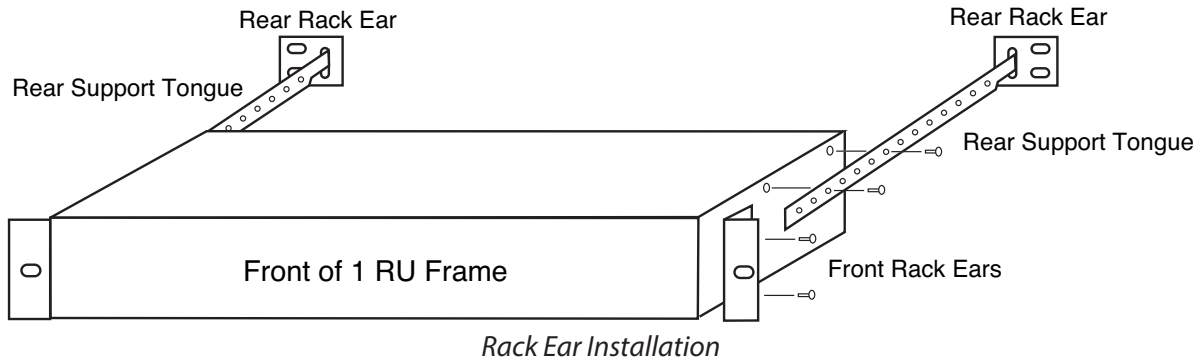

## Module Installation

### 1RU Frame

Modules are accessed and installed from the front of the frame. To access the modules in a 1RU frame, remove the cover from the frame front. Grasp the front cover on either side and pull out to remove it.

Any type of video and audio modules may be installed in any of the three cells from the left as shown below (except the 5440 8x8 Expansion Router which requires a two-cell expanse). They may be hot-swapped (installed or moved without powering down the frame) at any time. If a module has been remotely configured, it may be moved without losing configuration information.

The optional System Control module is installed in the lower right cell under the power supplies, as shown below. The Power Supply module is installed in the right top cell of the frame.

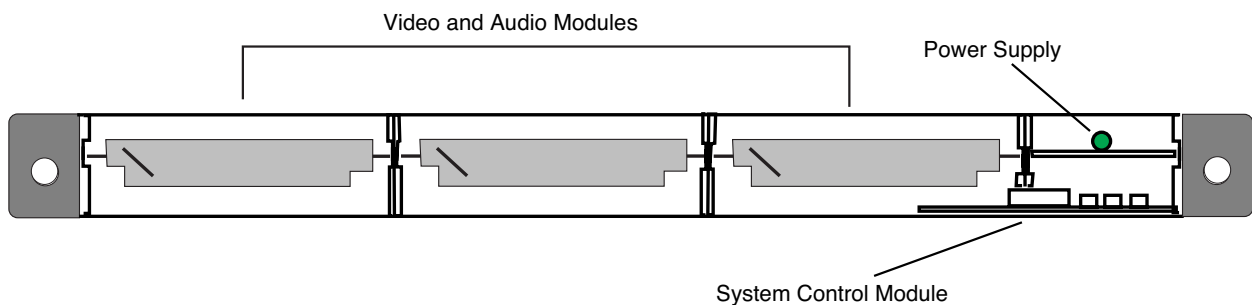

## 3RU Frame

To access and install modules in the 3RU frame, open the front door by depressing the latch on the left side of the frame and swinging the door open. The modules and power supplies are installed in the cell locations as shown in the figure at the top of the next page.

The video and audio modules may be installed in any of the first ten cells from the left. They may be hot-swapped (installed or moved without powering down the frame) at any time. If a module has been remotely configured, it may be moved without losing configuration information.

The System Control module is installed at the last cell before the power supplies, as shown on the next page. If the Touch Screen Panel option is installed in the front door, the ribbon cable from the System Control module must be connected to the corresponding connector (J3) on the inside of the front door as shown on the next page.

The Power Supply modules are installed in the rightmost cells of the frame. The ribbon cable from the power supply must be connected to the corresponding connector on the inside of the front door. This provides power to the fan and the Touch Screen option in the front door. If redundant power supplies are installed, one of the ribbon cables from either power supply should be connected to this connector.

**Note:** *Each power supply is protected from direct access by a metal safety panel. Removal of the safety panel exposes high voltages which can be a shock hazard. Power supplies should be installed and removed using the handle on the bracket only. When finished, replace the safety panel.*

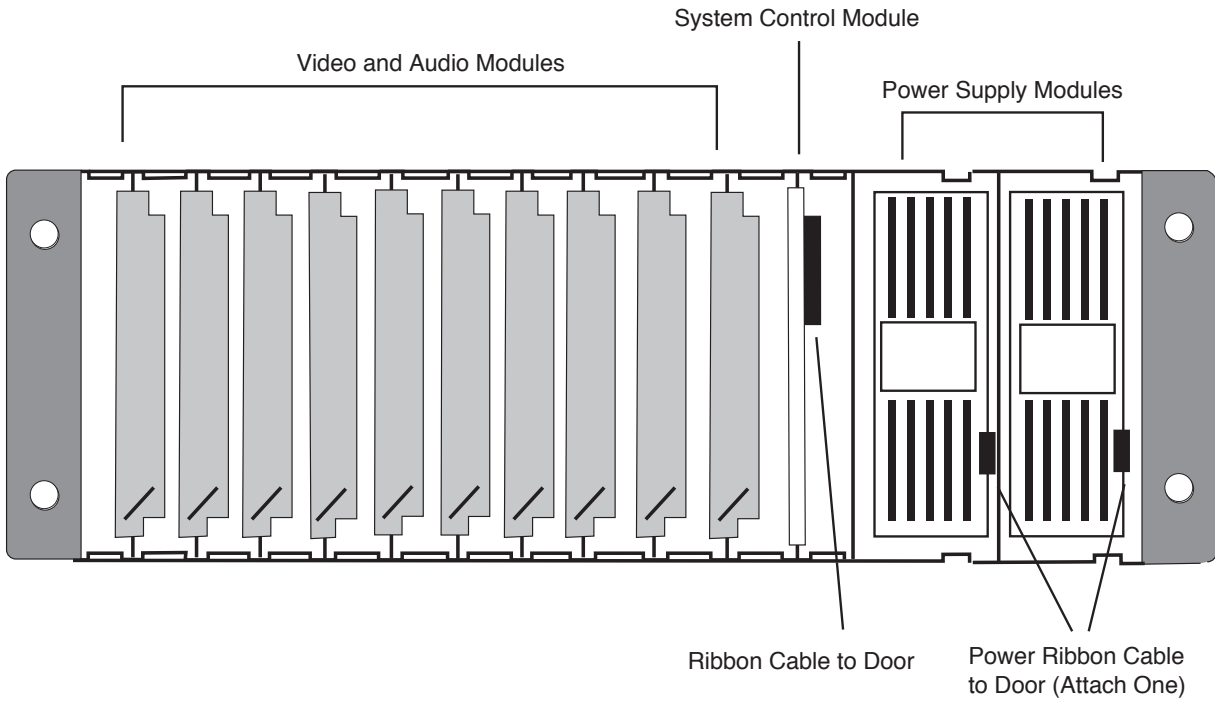

3RU Frame Module Installation (Front Door Not Shown)

### Inside Front Door

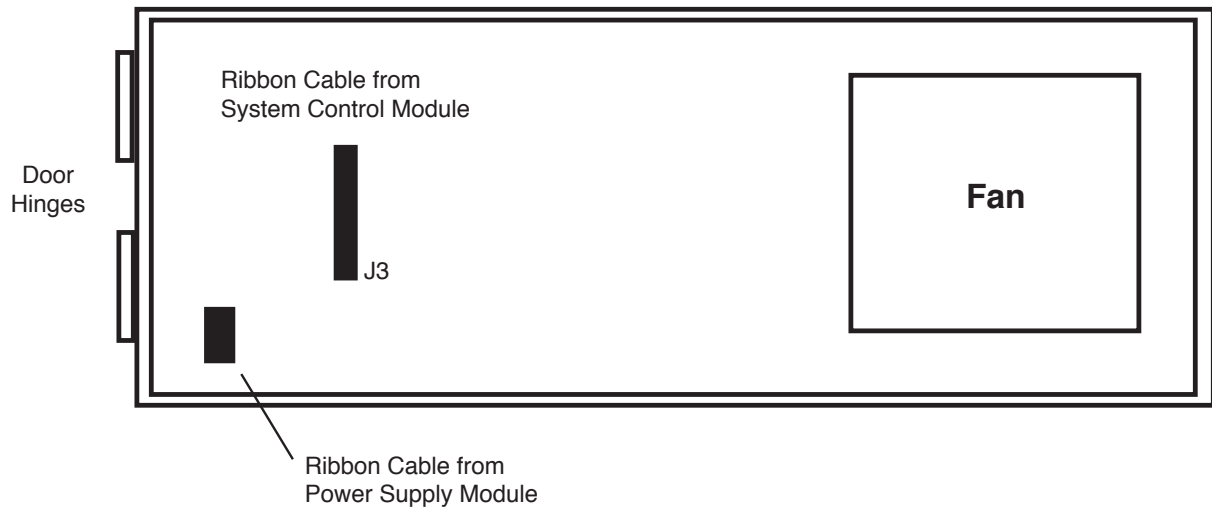

Inside of Front Door of 3RU Frame



## Avenue Touch Screen Installation

This section explains installation and cabling instructions necessary for using Avenue Touch Screen Control Panels. After installation, configuration of the network can be set up using the Touch Screen controls for each frame containing a Touch Screen and any Touch Screen Control Panels. Refer to [“Chapter 4: Networking”](#) on page 24 for more details about network configuration.

### Touch Screen Front Panel Installation

The Touch Screen Front Panel option comes installed in the front door of a 3RU frame. Connections to the Touch Screen panel are made from the frame to the inside of the front door. The Touch Screen is powered from the frame power supply. Note that a 5030 System Control module is required for any frame being controlled with an Avenue Touch Screen door.

### Tabletop Touch Screen Installation

The Tabletop Touch Screen Control Panel option can be set on any table surface, held as a laptop device or it can be installed directly into a standard 3RU half-frame of a waveform monitor with a TableTop rack mounting kit available from the Ensemble factory. (Call the factory to obtain the kit with part number TBKLTCPRK).

All Tabletop connections and adjustments are clearly labeled on the rear of the unit as shown in the illustration below. Power to the Tabletop Control Panel is through an in-line AC power converter that accompanies the unit. Connect the in-line power unit to the AC connection shown in the illustration.

The position of the Tabletop support bar can be changed by ratcheting the bar to any angle desired. Rack mounting requires removing the support bar and installing the metal bracket onto the rear of the control panel with four screws. To remove the support bar, remove the two screws holding it to the control panel with a 1/8-inch allen wrench. Locate the four holes in the rear of the control panel casing for attaching the bracket as shown below.

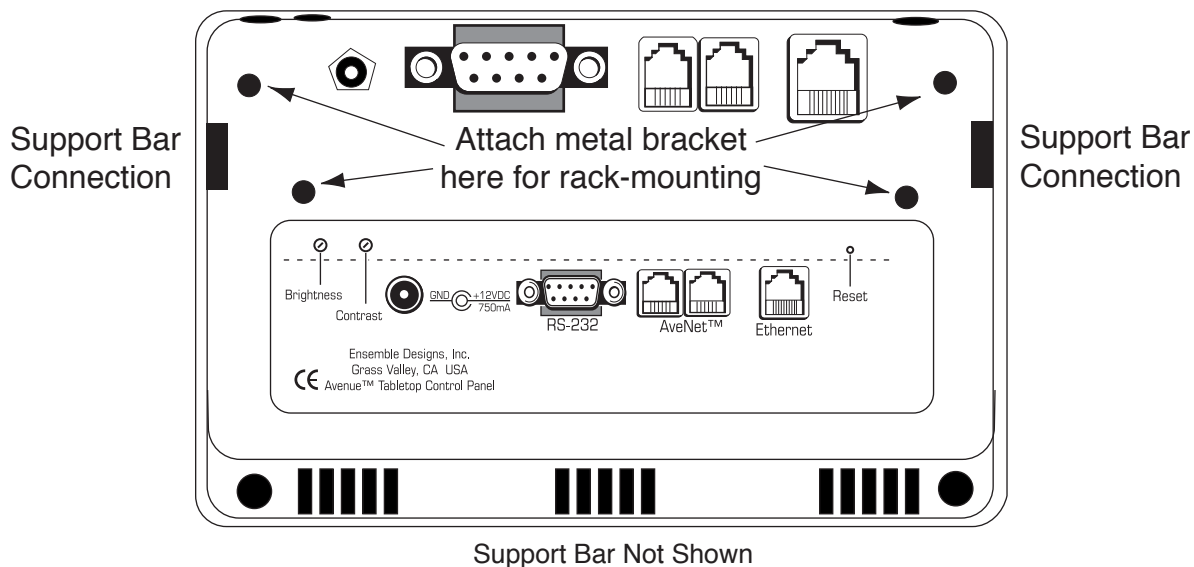

Tabletop Control Panel Rear View

Attach the front of the metal bracket to the rear of the Touch Screen panel with the four screws provided as shown in the figure below.

Install the entire assembly into one side of a waveform monitor and secure to the rack with two rear screws (not provided). Use the holes in the top rear of the metal bracket to secure cables from the control panel with cable ties if desired.

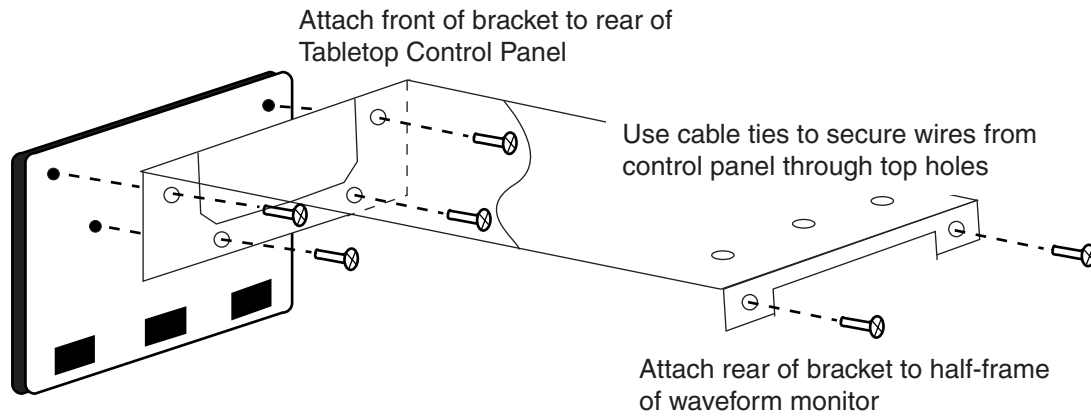

*Mounting Metal Bracket to Tabletop Control Panel*

# Chapter 3: Cabling

This chapter provides cabling instructions for Avenue 1RU and 3RU frames and the Tabletop Touch Screen Control Panel. Video and control cabling for individual Avenue modules is explained in detail in each module's manual. Use this chapter in conjunction with ["Chapter 4: Networking" on page 24](#) to configure Avenue systems. Refer to the separate Avenue PC manual for additional information on connections required for Avenue PC.

## Frame Cabling

The remote control connectors, Master Reference Input, and the AC connections on the left of the 1RU and 3RU frame backplanes are shown in the illustrations below.

## Video Connections

There is one Master Reference Input video connection to the frame in the control section of the 1RU and 3RU backplanes shown in the illustrations below.

### Master Reference (1RU and 3RU Frame)

The **Master Reference Input** BNCs are used in conjunction with the optional System Control module for distributing a common video reference to all modules installed in a frame. This is a looping input and should be terminated in  $75 \Omega$  if not looped to another destination. A Control module must be installed for the Master Ref input to be present.

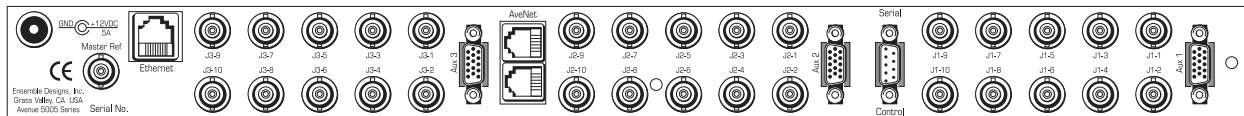

Avenue 1RU Frame Backplane

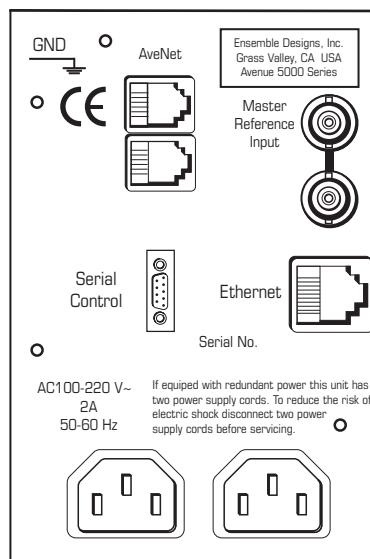

Avenue 3RU Frame Backplane Interface Connectors

## Control Connections

Use the remote control connections described below to interface an Avenue frame to a PC with the Avenue PC Control Application Software or using a Tabletop Touch Screen Control Panel. Remote control requires the presence of an optional System Control module in each frame being controlled.

### Ethernet

The Avenue frame may be controlled by a PC running the Avenue PC Control application software connected to a 10BaseT Ethernet network. The IP Address for each frame is set on the System Control module in the frame or frames connected to the Ethernet network. The Avenue backplanes have a standard RJ45 connector for Ethernet interface.

Each frame on the Ethernet network must have a different IP Address. The address is set using the Status menu functions on the front of the 5030/35 Control Module in each frame or a Touch Screen Panel if installed. Refer to [“Chapter 4: Networking” on page 24](#) for details.

### AveNet

**AveNet** is the Avenue control bus that allows communication between frames by the System Control modules in each frame. Up to 20 frames can be connected on each individual AveNet network. Any number of AveNet networks can then be connected together via Ethernet. PC control is not required for using AveNet. You may use a single Avenue Control Panel to control a group of frames. AveNet connection between frames requires looping between the standard RJ11 LAN connectors of each frame with standard phone cable or custom-made simple twisted pair LAN cable. The unused connectors must be terminated with 100 ohm LAN terminations at the first and last frames in the group. Pinouts of the RJ11 connector and termination are shown below.

Each Avenue device on the AveNet LAN network must have a different AveNet address. The address is set using the Status menu functions on the front of the 5030/35 Control module in each frame or a Touch Screen Panel if installed. Refer to [“Chapter 4: Networking” on page 24](#) for detailed information.

### RJ11 Connector

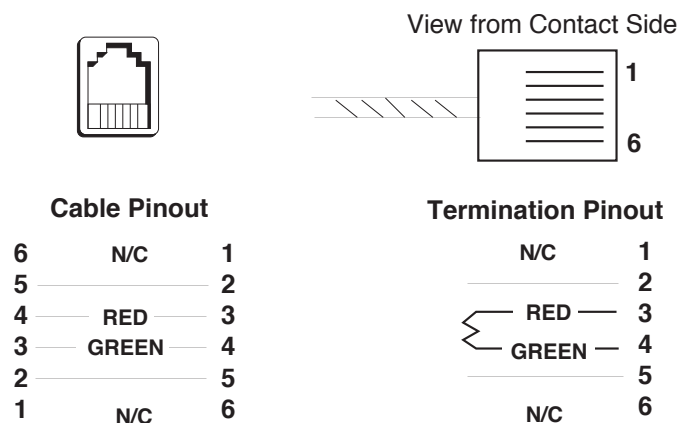

*AveNet RJ11 Connector Pinout*

## Serial Control

If you intend to remotely control a frame with the Avenue PC Control Application software through the PC serial port or using a Tabletop Control Panel serial connection, connect a 9-pin D to 9-pin D cable (pinout is shown in the pinout diagram below) from the **Serial Control** port on the Avenue frame to a serial port on your PC. Frames and control panels can be connected on an Ethernet or AveNet network.

Avenue PC can access any frame or control panels on the network. Refer to the Avenue PC Application documentation for PC setup information.

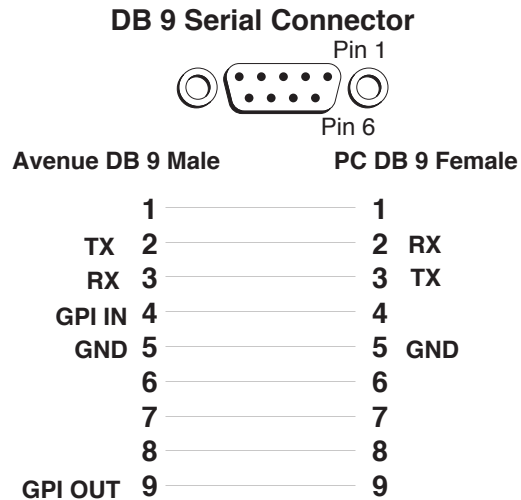

NOTE: A pin-to-pin cable may be used if the GPI signals are not being used.

*Serial Connector Pinout*

## Tabletop Control Panel Cabling

A Tabletop Touch Screen control panel can be interfaced to the network to control frames using the same control interfaces as described above. The rear connections to a Tabletop Control Panel are shown below.

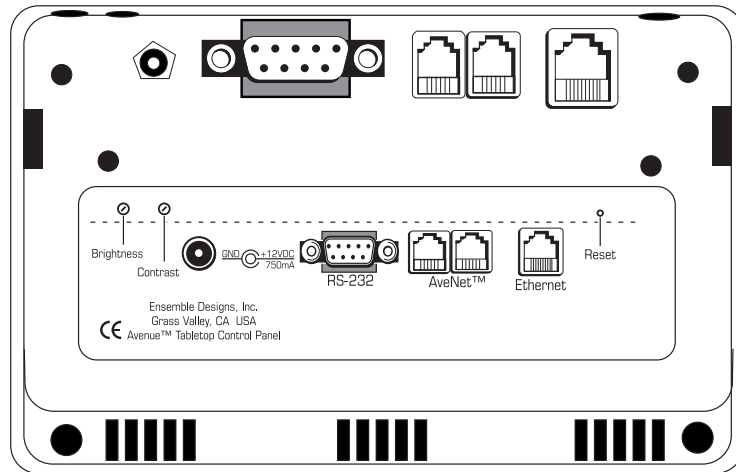

Support Bar Not Shown

*Tabletop Control Panel Rear Backplane*

## Express Panel Cabling

An Avenue Express Control Panel can be connected to the network to control frames using the same control interfaces as described above. Refer to the Avenue Express Control Panel manual that accompanies the panel for complete details.

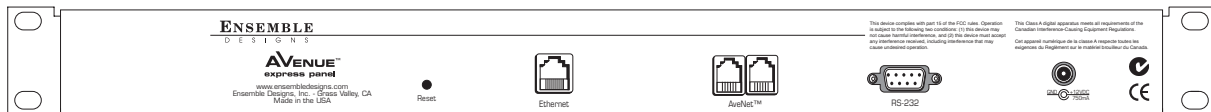

*Express Control Panel Rear Backplane*

## Module Cabling

Each frame module provides 10 BNCs and a 15-pin high-density control connector for various inputs and outputs depending on the functionality of the module. A plastic overlay is provided with each module to identify its inputs and outputs. The overlay is placed over the corresponding rear BNCs on the frame. The overlay may be placed permanently in position by using the adhesive backing on each overlay or simply placed over the BNCs allowing the modules to be moved if desired.

The orientation of BNCs and the 15-pin connector for modules in the 1RU and 3RU frames are illustrated below. Refer to individual module manuals for complete installation, setup and further cabling information.

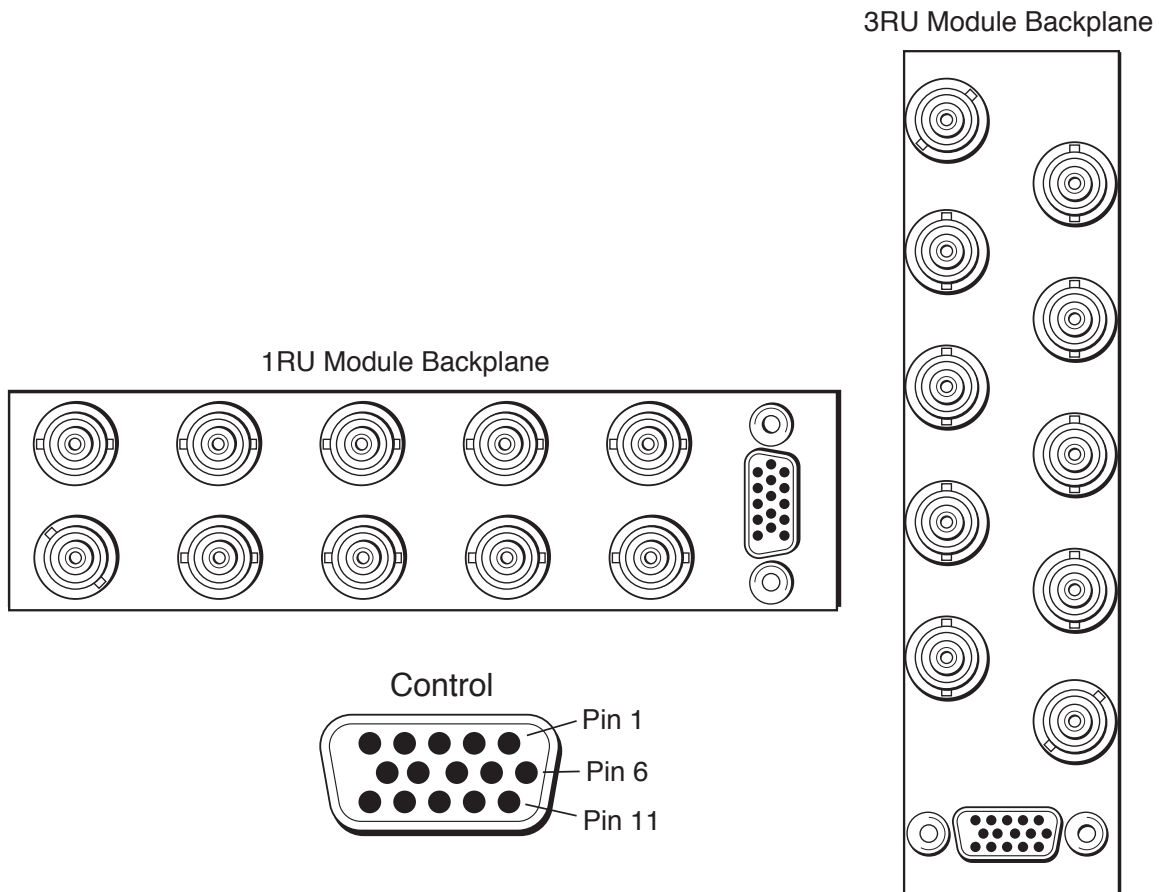

*Orientation of BNCs and 15-pin Connector for 1RU and 3RU Frames*

# Chapter 4: Networking

This chapter addresses how to connect Avenue frames and remote control points together over a network.

## Networking Prerequisites

In order for Avenue frames to be networked, a System Control module must be installed in each frame. The 3RU frame takes a 5030 System Control module. The 1RU frame takes a 5035 System Control module.

Additionally, the Remote/Local switch on each module must be set to **Remote** to be able to change a module's settings remotely. Once module parameters are set remotely, the information is stored directly on the module. Subsequently, a module may be moved to a different cell or frame without losing its configuration.

## Control Options

You can use a single control panel to control and configure multiple modules installed in one or more networked Avenue frames located in multiple locations. You can also use the Avenue PC Control software.

### Avenue Touch Screen Control Panels

All remote control features can be controlled by a Touch Screen installed in the front panel of the 3RU frame door or by a standalone Tabletop Touch Screen Control Panel. The Touch Screen Control Panel provides a series of menus to name frames, modules and groups of frames, and to configure module and system parameters.

### Express Panel

The Express Panel provides another means to control all remote control features for Avenue modules. The Express Panel, shown below, is a 1RU control panel that is especially well suited for ingest areas and remote trucks. It has dedicated knobs for proc controls and a menu display for controlling all other parameters.





## Avenue PC Control Software

With the Avenue PC Control option, you can access and control all frames and modules in an Avenue system. Avenue PC, available by CD or by download from the Ensemble Designs website, is supported by any Windows operating system.

To use Avenue PC, connect your PC to one of the Avenue frames (1RU, 3RU, or Intersection) through Ethernet or through a serial port.

Using Avenue PC, you can:

- name modules, frames and groups of frames.
- configure, control and monitor modules.
- save module configuration settings to a file and download them to a different module.
- create "Virtual Modules".

Virtual Modules are custom menus that combine functionality from any modules in the system. You can group and customize both menus and parameter names. With Virtual Modules, you can include controls from several different modules present in your system such as an embedder, a video converter, and an audio delay module.

Virtual Modules are authored with Avenue PC, then exported to a control point on the network.

## Four Approaches to Networking Avenue Systems

The four types of Avenue networks you can set up are described and illustrated on the following four pages. You can of course create variations on these four themes. These four types are:

1. Ethernet Star Configuration
2. Ethernet Hub with AveNet Groups and Control Panels
3. Direct Connection of Two AveNet Groups Over IP
4. AveNet Interconnection Only

## 1. Ethernet Star Configuration

Frames, control panels and computers running Avenue PC can be networked over Ethernet. This first example illustrates the most commonly used approach when Ethernet ports are available in each frame location.

An Ethernet cable from the hub or switch is connected directly to the Ethernet port of each frame or control panel, creating a star configuration. AVIP (AveNet over IP) is turned on for each frame and control panel. AVIP enables frames to send and receive AveNet information through the Ethernet ports. For this type of configuration, the AveNet ports are not used. Rather, all network connectivity is going through the Ethernet ports.

The frames and control panels are addressed sequentially, using numbers 1 through 6. Each frame with an Ethernet connection is given a unique IP address. Note in the example below how each frame or control panel is configured with respect to these factors:

- AVIP
- AveNet address
- Lower AveNet address
- Upper AveNet address
- IP address

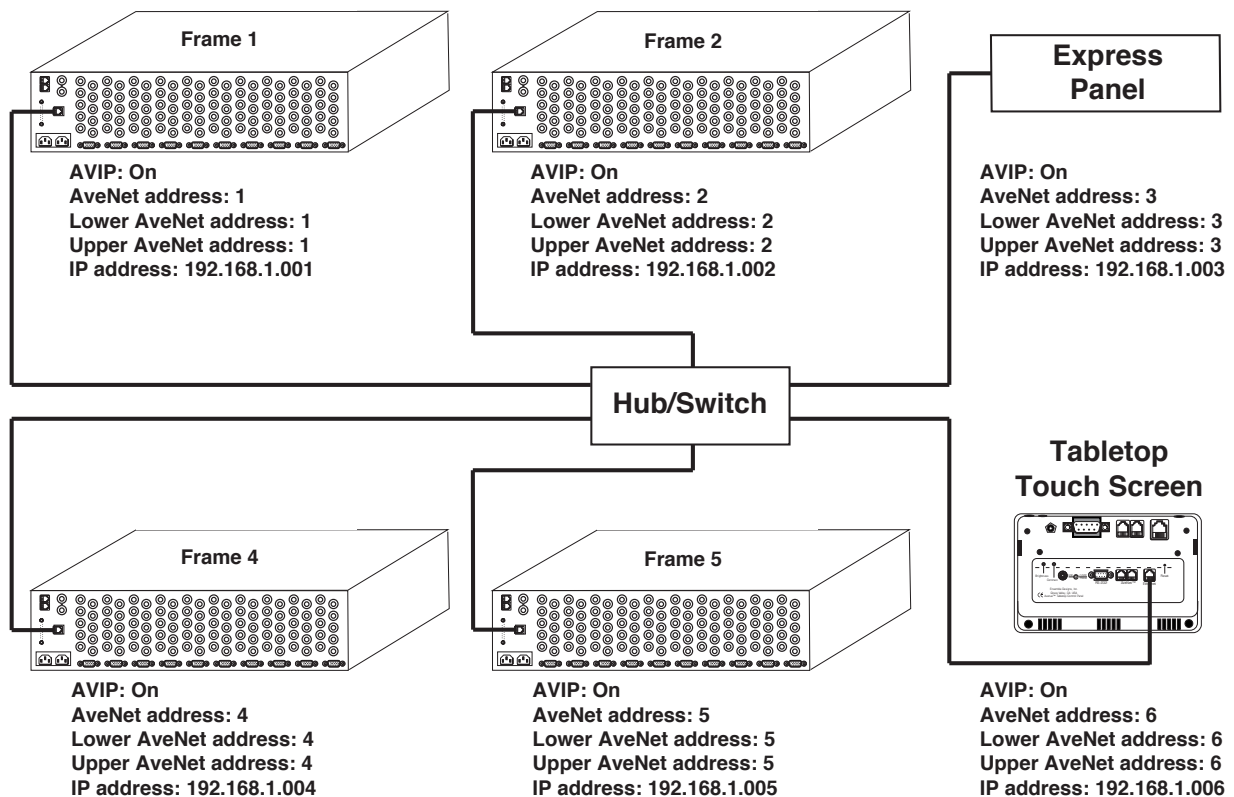

## 2: Ethernet Hub with AveNet Groups and Control Panels

In this second example, Ethernet is used in conjunction with AveNet, and fewer IP addresses are needed. This approach is useful when fewer IP addresses are available or when you want to use AveNet groups for work flow purposes.

Unique IP addresses are assigned only to components that are directly connected to the Ethernet hub; in this instance, those components are Frame 3, Frame 7, the Tabletop Touch Screen control panel, and the computer running Avenue PC.

AVIP (AveNet over IP) is turned On for Frame 3, Frame 7, and the Tabletop Touch Screen control panel. AVIP enables frames and control panels to send and receive AveNet information over Ethernet.

Every frame and the Tabletop Touch Screen control panel require an AveNet address. They use sequential AveNet addresses 1 through 7.

Frames 3 and 7 also have Lower AveNet and Upper AveNet addresses assigned, encompassing the AveNet addresses of the frames in their respective groups. This enables them to recognize and communicate with the frames in their groups.

The AveNet information generated by the Avenue system is carried among the two frame groups, the Tabletop Touch Screen control panel and the Avenue PC workstation through the RJ45 Ethernet cable, then distributed to the frames in each frame group through the RJ11 AveNet cables. A 100 ohm termination is plugged into the unused AveNet ports of Frame 1, Frame 3, Frame 5 and Frame 7 to properly terminate the cable at both ends of each frame group.

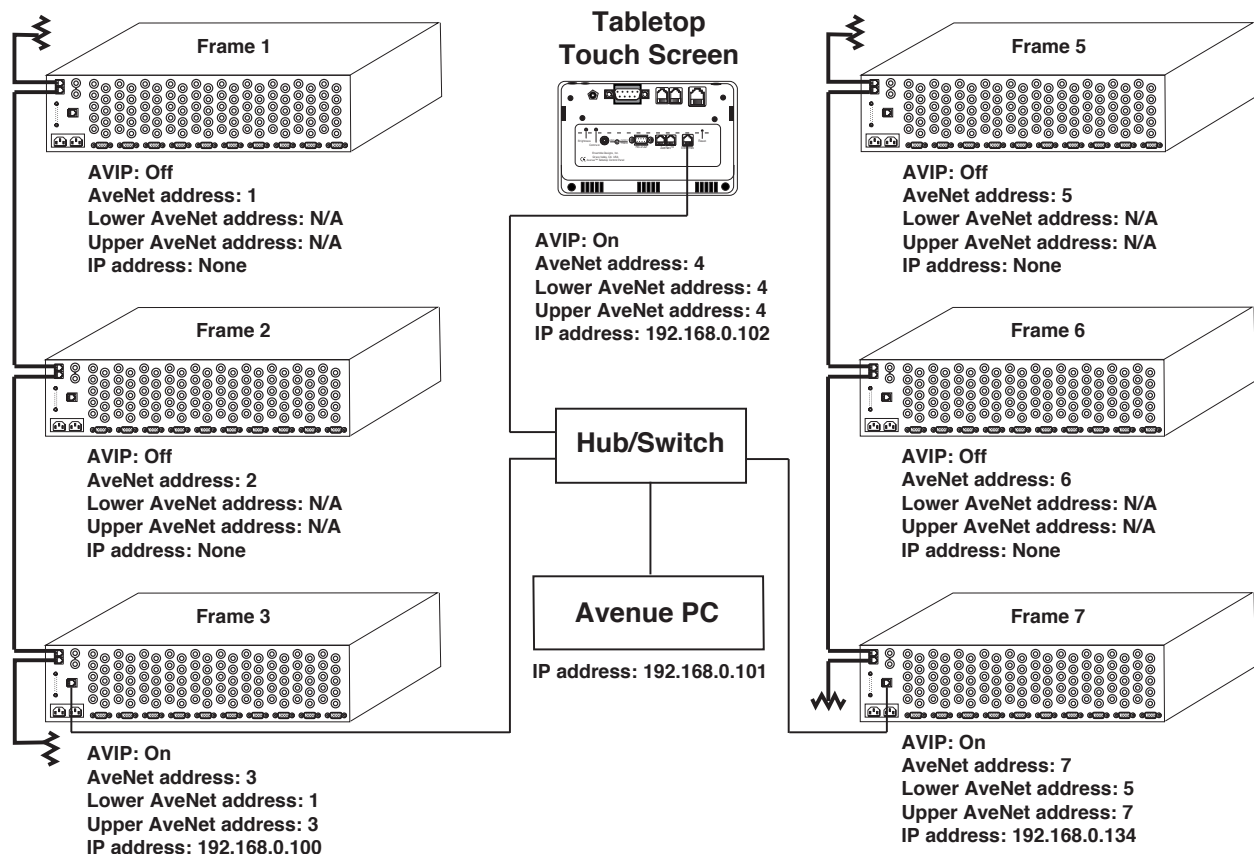

### 3: Direct Connection of Two AveNet Groups Over IP

When only two groups of frames need to be connected, use an **Ethernet crossover** (or reversing) cable as shown below. Note that no hub/switch is needed when there are only two groups of frames.

In this example, each frame and control panel uses an AveNet address. Only Frame 3 and Frame 7 require an IP address since they are the only frames using Ethernet ports to connect to the Ethernet cable. Additionally, Frame 3 and Frame 7 need to set Lower AveNet addresses and Upper AveNet addresses to recognize and communicate with the frames in their AveNet groups.

The AveNet ports are connected by RJ11 cable. A 100 ohm termination is plugged into the unused RJ11 jacks of Frame 1, Frame 3 and Frame 7 to properly terminate the cables.

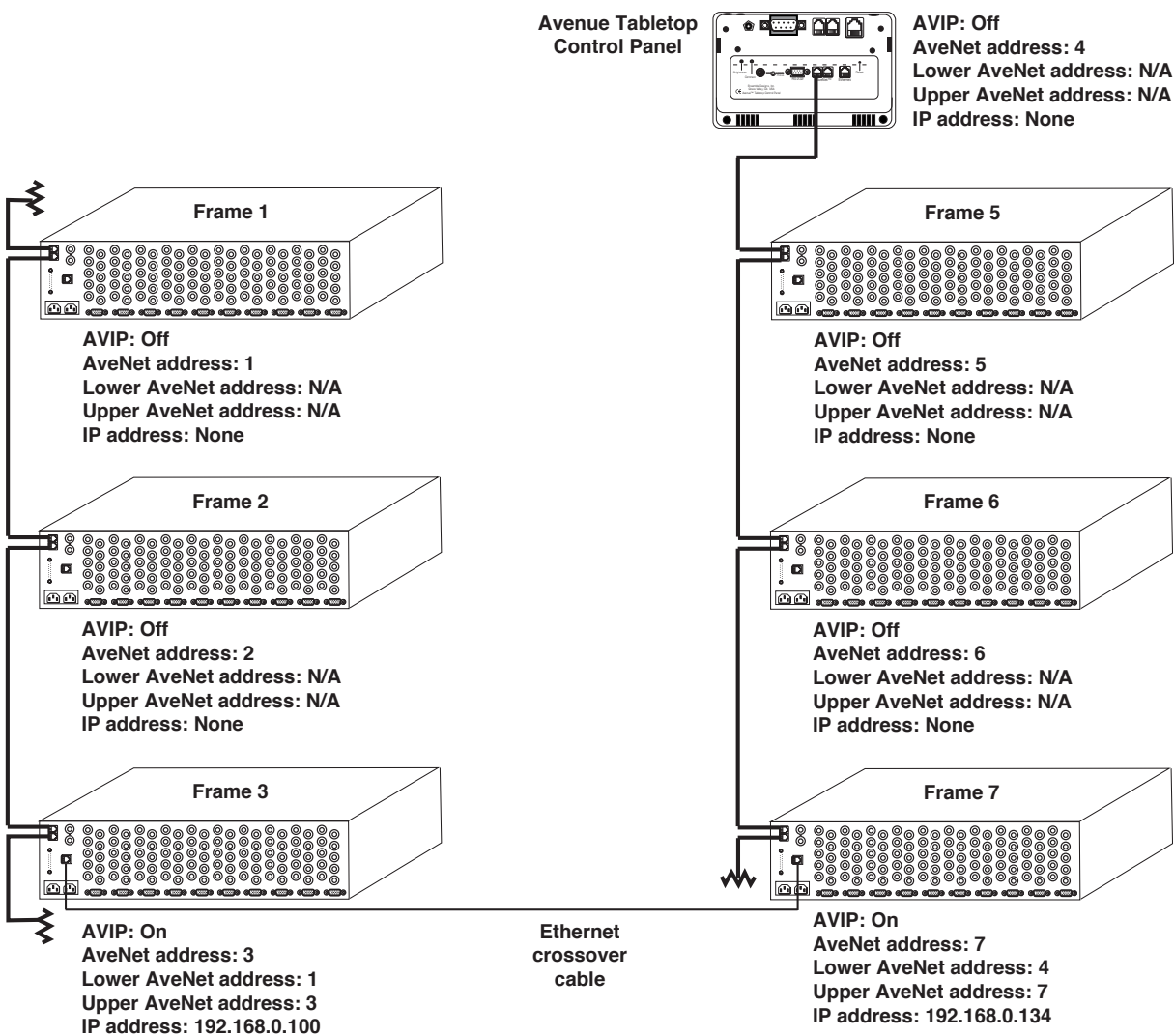

## 4: AveNet Interconnection Only

When there is no need to integrate with an Ethernet network, a single Touch Screen panel (installed on Frame 1 in this example), Tabletop Control Panel, or Express Panel can control and configure one or more Avenue frames through AveNet exclusively. For this type of configuration, all network connectivity is going through the AveNet ports. Because no Ethernet connectivity is being used, AVIP (AveNet over IP) is turned off on each frame.

The AveNet ports are connected by RJ11 cable. A 100 ohm termination is plugged into the unused RJ11 jacks of Frame 1 and Frame 3 to properly terminate the cable at each end.

Each frame or control panel must have a unique AveNet address. In this example, the frames are addressed sequentially, using AveNet addresses 1, 2 and 3. The AveNet addresses are the only configuration parameters required.

When the Select Frame/Module button is pressed on Frame 1's Touch Screen front panel, the 5030 Control module in Frame 1 sends a query along the RJ11 cable and the connected frames respond with information about their installed modules.

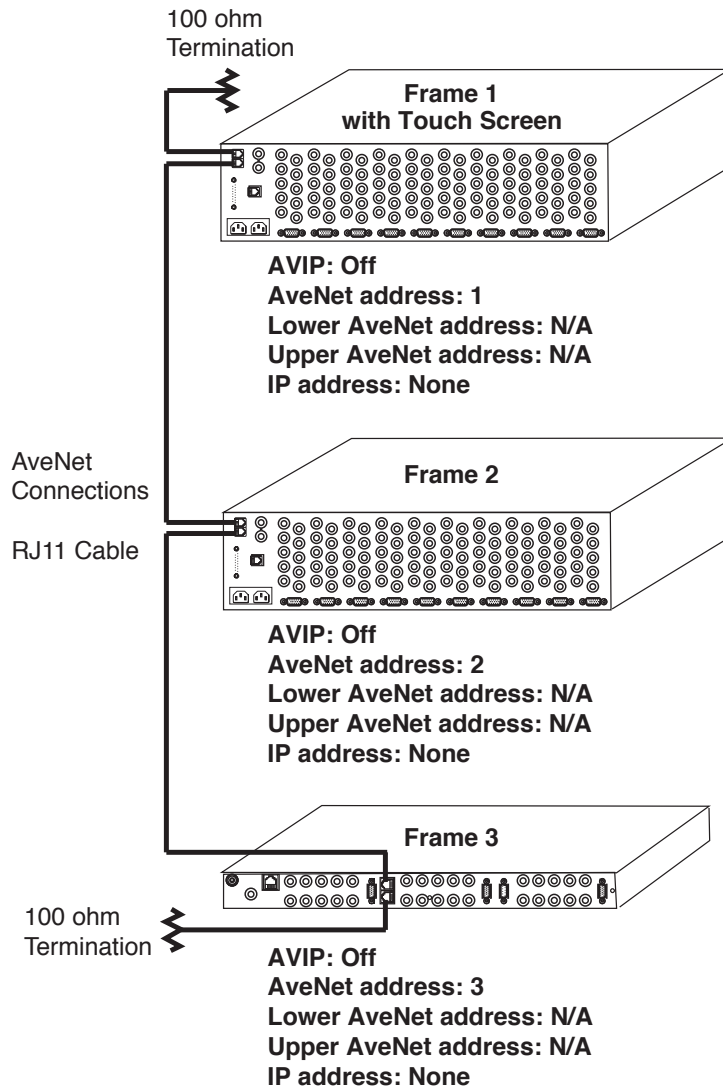

## Configuring Each Frame's System Control Module

For each frame in your network, you will need to configure its System Control Module—the 5030 for the 3RU frame and the 5035 for the 1RU frame. Each frame's configuration will vary according to its role in the network and according to the type of network you are setting up, whether you are using Ethernet, AveNet, or a combination of the two.

Through each System Control Module's configuration controls, you can do the following:

- Display the current software version running on the System Control Module
- Set the addresses for AveNet, IP, Subnet Mask, Gateway, and Distant IP
- Reset the Touch Screen Panel calibration
- Set the Fan to Auto or Full
- Enable or disable AVIP (AveNet over IP)
- Set lower and upper AveNet addresses for a frame group

### 3RU Frames

To configure the System Control Module for 3RU frames, use the Touch Screen Door if you have one installed. Otherwise, use the front panel switch controls located directly on the 5030 System Control Module. The 5030 module is installed in the dedicated slot to the right of the 3RU frame's ten slots for video and audio modules.

### 1RU Frames

To configure the System Control Module for 1RU frames, use the front panel switch controls located directly on the 5035 System Control Module. The module is installed in the dedicated slot to the right of the 1RU frame's three slots for video and audio modules, and below the power supply.

## 5030 and 5035 Front Panel Controls and Indicators

The Status menu display and configuration switches are shown in the illustration below.

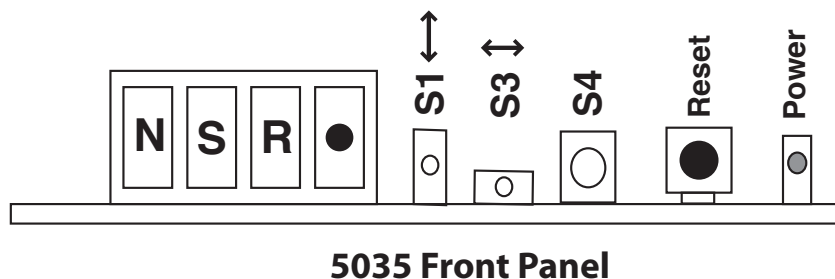
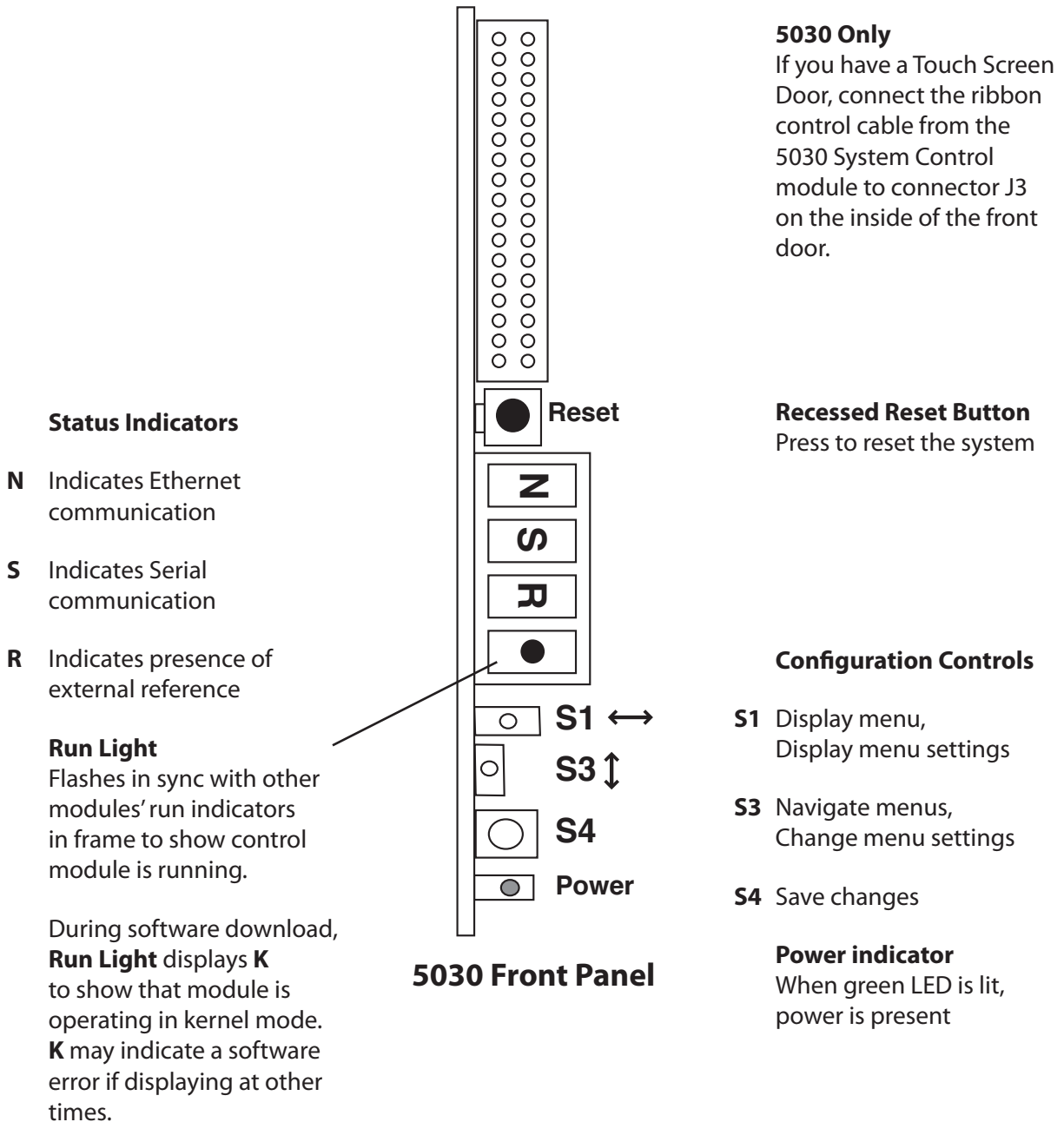

## Control Module Configuration Menus

Menu	Definition	Value Range or Function
Ver	system software version	Reports current software version
Adr	AveNet address	1 - 1023
V Ip	IP address	0 - 255 for each segment
V Ma	SubNet Mask address	0 - 255 for each segment
V Ga	Gateway address	0 - 255 for each segment
V Di	Distant IP address	0 - 255 for each segment
Tch	Touch Screen	Press S4 (Enter) to reset calibration
Fan	Fan settings	Auto, Full
AVIP	AveNet Over IP	On, Off
Lo A	Lowest AveNet address in frame group	1 - 1023
Up A	Upper (highest) AveNet address in frame group	1 - 1023
ip1	first segment of IP address	0 - 255
ip2	second segment of IP address	0 - 255
ip3	third segment of IP address	0 - 255
ip4	fourth segment of IP address	0 - 255
Mas1	first segment of SubNet Mask address	0 - 255
Mas2	second segment of SubNet Mask address	0 - 255
Mas3	third segment of SubNet Mask address	0 - 255
Mas4	fourth segment of SubNet Mask address	0 - 255
Gat1	first segment of Gateway address	0 - 255
Gat2	second segment of Gateway address	0 - 255
Gat3	third segment of Gateway address	0 - 255
Gat4	fourth segment of Gateway address	0 - 255
Dis1	first segment of Distant IP address	0 - 255
Dis2	second segment of Distant IP address	0 - 255
Dis3	third segment of Distant IP address	0 - 255
Dis4	fourth segment of Distant IP address	0 - 255



## **Enabling AVIP (AveNet over IP)**

AVIP enables frames to send and receive AveNet information through the Ethernet ports. When an Ethernet cable from a hub or switch is connected directly to the Ethernet port of a frame or control panel, AVIP needs to be turned on.

### **To Enable or Disable AVIP**

1. From the 5030 System Control Module front panel, navigate to the AVIP menu by pressing S3 up or down sequentially until "AVIP" displays on the Status Menu light panel. AVIP is the ninth selection on the menu.
2. Press S1 to the left once to display the AVIP menu's current setting. The Status Menu will display either On or Off.
3. Press S3 up or down to toggle to the setting you want.
4. Press S4 to set your selection. "Set!" displays for a moment on the Status Menu.

## **Setting the AveNet Address**

Each frame or control panel in a network must have a unique AveNet address. AveNet addresses can have values ranging from 1 to 1023.

### **To Set the AveNet Address**

1. From the 5030 System Control Module front panel, navigate to the Adr (AveNet address) menu by pressing S3 up or down sequentially until "Adr" displays on the Status Menu light panel. Adr is the second selection on the menu.
2. Press S1 to the left once to display the Adr menu's current setting.
3. Press S3 up one or more times to decrease the value or down one or more times to increase the value until the menu is displaying the value you want.
4. Press S4 to set your selection. "Set!" displays for a moment on the Status Menu.

## Setting the AveNet Lower and Upper Addresses

When networking one or more groups of frames, you need to enter the lowest AveNet address (Lo A) and highest AveNet address (Up A) used by the frames in each group into the controlling frame's System Control Module. This enables the controlling frames to recognize and communicate with the frames in their respective groups. AveNet addresses can have values ranging from 1 to 1023.

### To Set the AveNet Lower and Upper Addresses

1. From the 5030 System Control Module front panel, navigate to the Lo A (Lowest AveNet address) menu by pressing S3 up or down sequentially until "Lo A" displays on the Status Menu light panel. Lo A is the tenth selection on the menu.
2. Press S1 to the left once to display the Lo A menu's current setting.
3. Press S3 up one or more times to decrease the value or down one or more times to increase the value until the menu is displaying the value you want.
4. Press S4 to set your selection. "Set!" displays for a moment on the Status Menu.
5. Navigate to the Up A (Upper AveNet address) menu by pressing S3 up or down sequentially until "Up A" displays on the Status Menu light panel. Up A is the eleventh selection on the menu.
6. Press S1 to the left once to display the Up A menu's current setting.
7. Press S3 up one or more times to decrease the value or down one or more times to increase the value until the menu is displaying the value you want.
8. Press S4 to set your selection. "Set!" displays for a moment on the Status Menu.

## Setting the IP Address

Frames, control panels and computers running Avenue PC can be networked over Ethernet. Assign a unique IP address to each frame or PC that will be using an Ethernet connection.

### To Set the IP Address

For each of the four segments of the IP address, follow these steps:

1. From the 5030 System Control Module front panel, navigate to the IP address segment you are configuring by pushing S3 up or down sequentially until "ip1," "ip2," "ip3," or "ip4" displays on the Status Menu light panel. The IP address segment menus are located at the 12th through the 15th position on the menu.
2. Press S1 to the left once to display your chosen IP address segment's current setting.
3. Press S3 up one or more times to decrease the value or down one or more times to increase the value until the menu is displaying the value you want.
4. Press S4 to set your selection. "Set!" displays for a moment on the Status Menu.

For 3RU frames with a Touch Screen Front Door installed and on a Tabletop Control Panel, you may set or change the IP and AveNet addresses, enable and set parameters for AveNet Over IP and name the control Name and Group using the **Configuration Menu**. Select **Configuration** from the top level **Home** menu on the Touch Screen shown below.

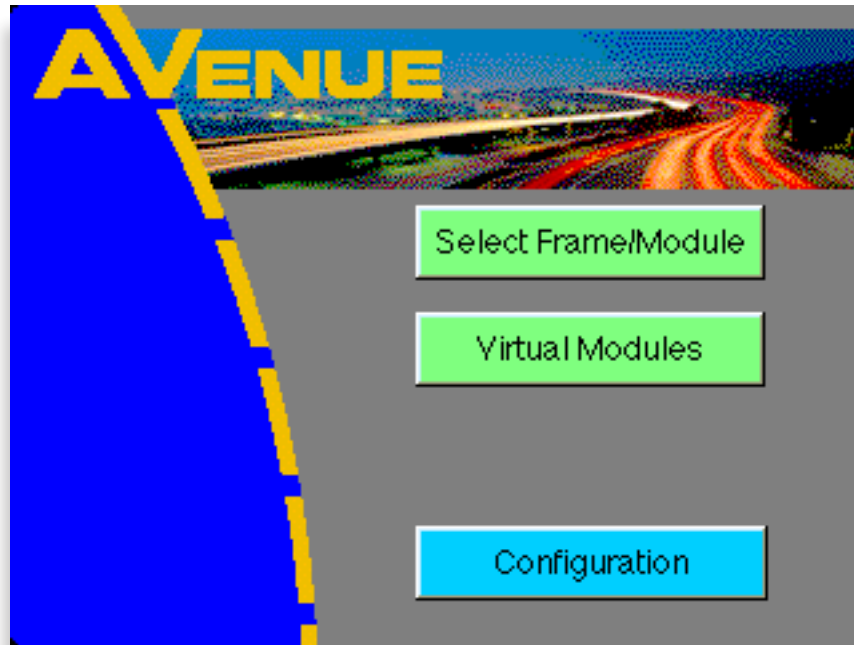

The Configuration Menu shown below displays the local frame configuration information including the current software version and the Control name and group. Push the Network Config selection to bring up the networking menu. The Touch Calibration menu allows you to calibrate the Touch Screen and is explained in detail in the Touch Screen manual.

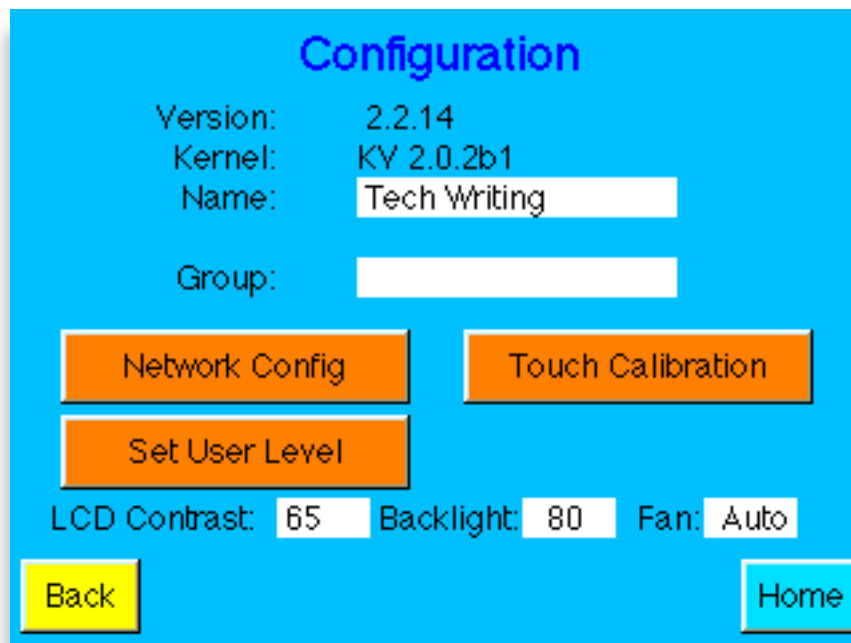

Use the Network Configuration menu (shown below) to set the AveNet and IP Addresses for the frame.

Enable the AveNet over IP Routing (AVIP) function by pressing the Enable field. Enter the lowest numbered frame AveNet address in the frame group in the Lower field. Enter the highest numbered frame AveNet address in the frame group in the Upper field. Use the keypad explained below to enter the parameters.

**Network Configuration**

AveNet	Internet
Address: 25	IP Address
AveNet over IP Routing	192.168.0.125
Enable AVIP On	SubNet Mask
Local Range	255.255.255.0
Lower: 25	Gateway
Upper: 25	0.0.0.0
Distant	

Module Selection / Navigation

Module Type: Phys & Yir Server Avenet Adr: 1

Back Home

To set or change the parameters for the frame, push the number field to bring up the Number Pad as shown in the illustration below.

To change a value, use **Del** to backspace. Enter a value using the keyboard touch pad and press **ENTER** to finalize the selection. The **Number Pad** window will then close.

To cancel at any time and close the **Number Pad** window, press **Cancel**. The selection will remain unchanged. The **Default** selection is used when setting module parameters.

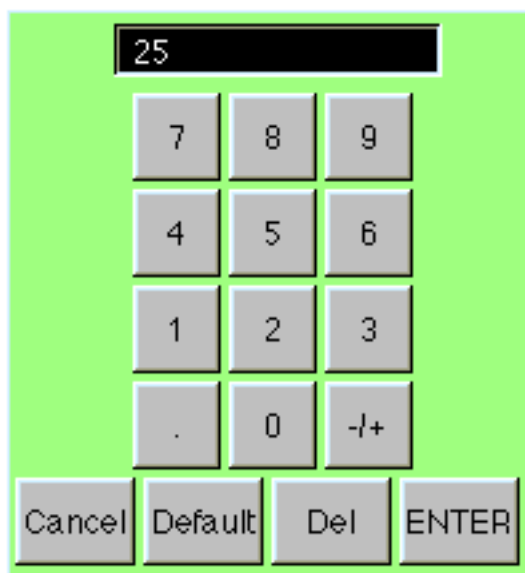

For large networks, such as a frame located in another city for example, it may be necessary to use the Distant IP feature in the Network Configuration menu to establish communications. Distant IP is used as follows when an IP address is outside the Local Subnet Mask:

- In the Gateway field, enter the IP address of your router to the distant network.
- Press the **Distant** button and enter the IP address of the targeted frame at distant locations into the **Distant IP** table that appears as shown below. The corresponding indicator in the table will turn green if a response is received from the distant frame.
- Avenue PC also uses this Distant table to locate distant frames on the network.

The default **Local Subnet Mask** is 255.255.255.000. This is the Class C mask which allows 256 local addresses. If the mask were 255.255.255.254.000, then 512 local addresses would be allowed. Anything not falling into this group would be Distant. The Gateway address is the IP address of the router which connects to the Distant network. Remember that all AveNet addresses must be unique over the entire network.

1	122.23.124.12	■	7	0.0.0.0	■
2	122.32.54.117	■	8	0.0.0.0	■
3	85.102.0.24	■	9	0.0.0.0	■
4	0.0.0.0	■	10	0.0.0.0	■
5	0.0.0.0	■	11	0.0.0.0	■
6	0.0.0.0	■	12	0.0.0.0	■

Back Home

The **Module Selection/Navigation** area of the Network Configuration menu provides the following two controls:

- **Module Type** – select the type of modules you wish to view in the Module list. Physical Only, Virtual Only, or both Physical and Virtual Modules can be shown in the Touch Screen module list. The Physical modules are those that are present in the networked frames. Virtual Modules are custom groups of menus and parameters based on Physical modules that can be created using the Avenue PC Application software as explained in the **Operations** chapter of this document.
- **Server AveNet Adr** – This is the AveNet number of the frame (Control module) that is assigned to act as the storage location for any Virtual Modules created with the Avenue PC software application as described later in the **Operations** chapter of this document. Any frame (Control module) communicating with the Avenue PC application can be used as the Virtual Module server. This control does not need a value if no Virtual Modules are being used.

## Avenue Security Overview

The Avenue system offers a number of security features, from limiting access to individual module parameters to the ability to completely lock out a module or dedicate control of a module from one specific control point. This section provides an overview of the available security features.

Avenue offers several types of remote control devices for accessing frame modules: the Avenue Touch Screen in a Tabletop Control Panel or installed in the front of a 3RU frame, the Express Panel, and the Avenue PC Application software installed on a networked PC. These devices act as control points for all networked frames.

There are two types of remote control security: User Levels and Module Lock.

### User Levels

Every Avenue module running software version 2.0 and later has a User Level assigned to every control parameter. These User Levels are assigned in software at the factory and may be changed using Avenue PC if desired by a user with Administrator access. User Levels for each parameter are listed in the specific module manual parameter table and in the **Edit Module User Level** menu in the **Module** pulldown in Avenue PC.

There are four User Levels, **Admin**, **Level 1**, **Level 2**, and **View Only**. User Levels are defined to allow limited access to some parameters that may be in a critical path or need to be locked out to some users. This allows limiting changing of some parameters while permitting view only status and allowing other parameters to be changed.

Access to each User Level through the Touch Screen is done by selecting the **Set User Level** button in the **Configuration** menu which brings up the **User Level** menu screen (shown at left below).

The same function is also available from Avenue PC in the User Level control in the File pulldown (shown below at right).

Any User Level can be protected by setting a 4-digit Pin number for each level by a user with Administrator privileges.

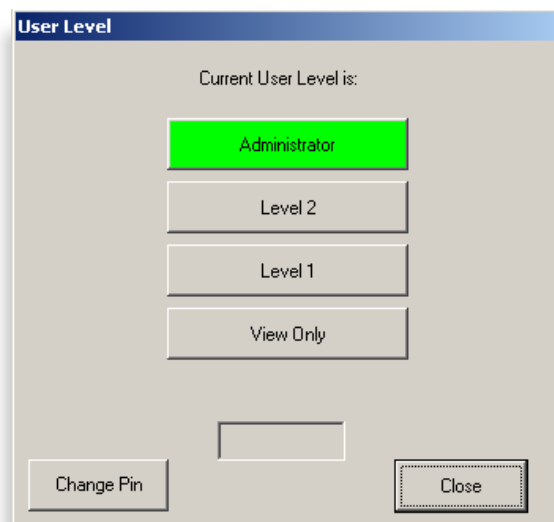
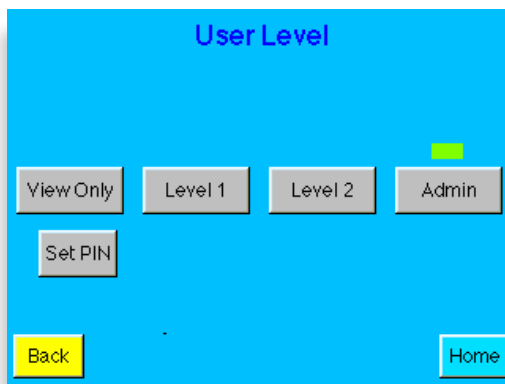

For example, a user given Level 1 access can log onto the control point (Touch Screen or Avenue PC) and have control over all parameters at Level 1. All inaccessible levels will be viewable but grayed out. When a user tries to access a parameter they do not have permission for, a message will pop up reporting that access is denied at this level.

The same is true for Avenue PC operation. When a parameter is not accessible from the current level, the parameter in the module screen will be grayed out.

Specific instructions for setting User Levels with the Touch Screen are explained later in this document in the **Touch Screen Configuration** section. Refer to the Avenue PC manual for specific instructions on setting User Levels with the application.

## Module Lock

Modules can also be locked out entirely or set so that only a single control point has access to changing parameters. Each Avenue module running software version 2.0 and later also has this module lock function. The module lock function operates in one of three modes:

1. Module access is open to all control points (except for individual parameter level User Level access).
2. Module is locked completely to all changes (regardless of User Levels set for each parameter).
3. Module access is locked to only one control point on the network (all other control points do not have access). This module must be locked directly from the specific control point.

Modules can only be locked by a user with Administrator privileges. Access to module locking is available from any networked Avenue PC Touch Screen (in a frame front or TableTop) or the Avenue PC application on a PC connected to the same network.

Locking modules using the Touch Screen and Avenue PC is summarized below.



### Avenue Touch Screen

From a Touch Screen, if a module has been locked, it will appear with a lock symbol in the Touch Screen Frame List as shown in the example for the 7400 Sync Pulse and Test Signal Generator module in the figure below.

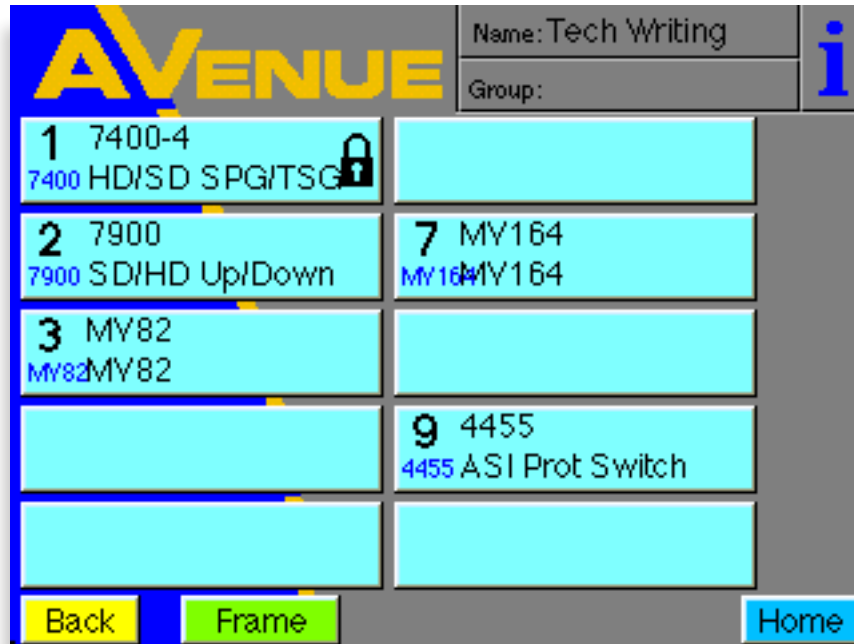

Select the module on the Touch Screen Frame List shown above to bring up the main module screen. Note the module lock symbol will also be shown in the upper right corner. All parameters will be grayed out and inaccessible. Selecting a parameter field will bring up the following message:

**“This module is locked. You cannot make any control changes from this panel!”**

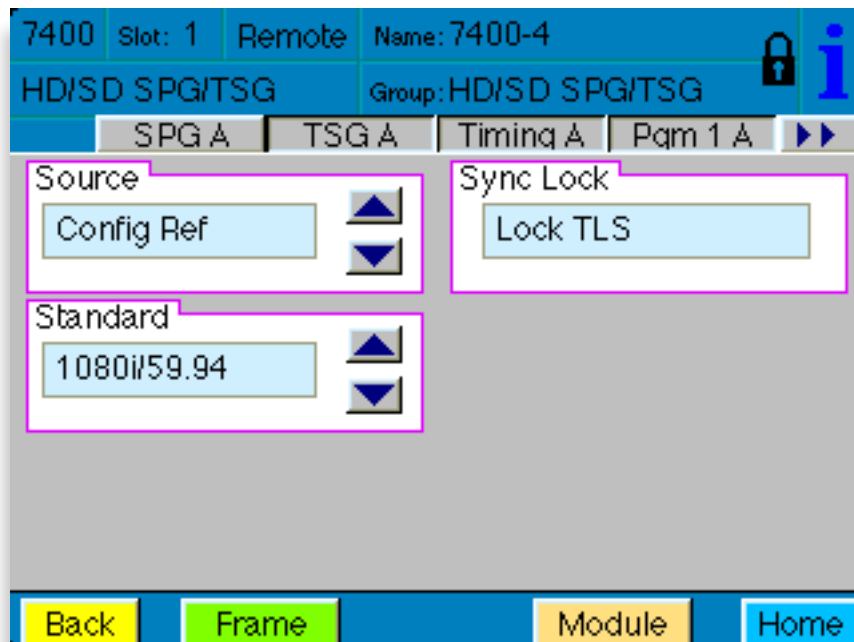

If the user has Administrator privileges, they may access the Module Information screen shown below by pressing the “i” field at the top right of the previous screen. If a user without Administrator privileges attempts to access this view, the following message will pop up:

**“User Level must be set to Admin to edit this parameter.”**

In the Module Information screen the Administrator can determine if the module has been locked out from a specific control point by pressing the Mod Lock Status field. The module will either change to All Access or show the AveNet address of the locking control point device on the Avenue network.

AveNet addresses for each Touch Screen control point on the network are listed in the Frame List accessible by pressing the Select Frame/Module button on the Home menu page.

For information on modules locked with Avenue PC, refer to the next section.

The screenshot displays the 'Module Information' screen with the following data:

Module Information	
Model: 7400	Function: HD/SD SPG/TSG
Manufacturer	
Name: 7400-4	Mod Lock Status
Group: HD/SD SPG/TSG	Locked
Located in Frame:	
Ser No: GWHP1754	Name: Tech Writing
S/W Ver: 2.2.5	Group:
H/W Ver: 7400-0	ANetAdr: 25
00:06:53:15	Slot: 1

At the bottom of the screen are four buttons: Back (yellow), Select Frame (green), Connectors (grey), and Home (blue).

## Avenue PC

On Avenue PC, the same locked 7400 SPG / TSG module will appear as shown in the Main screen below. The status of the selected module in the Frame list will be reported in the Main Avenue PC screen in the Lock Status field circled below. The Lock Status will report **Locked**, **Unlocked**, or the AveNet address of another specific control point from which the module has been locked. Note that the **Module** pulldown is also grayed out, so changes cannot be made to this module configuration, unless an Admin user had logged in.

A user with Administrator privileges can log in to the User Levels on Avenue PC (select **File/Change User Levels**) and access the **Edit Frame/Module Configuration** screen shown above.

The Administrator user may now unlock the module by selecting the **Unlock** button. The module may now be locked by selecting the **Lock** button or locked to this specific control point by selecting the **Lock Adds** button.

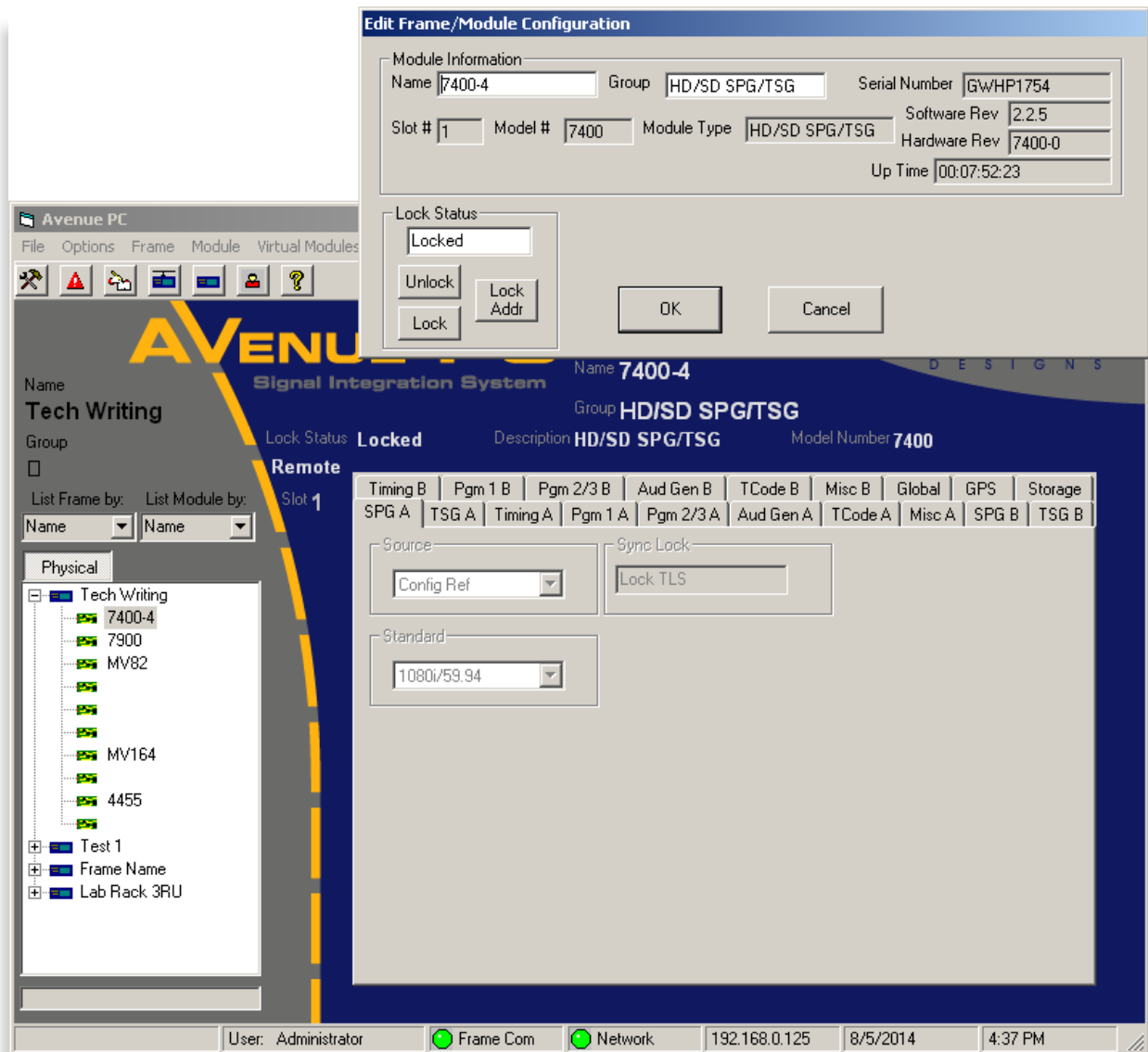

The AveNet address of this PC is determined by the frame targeted in the **Preferences** pulldown under the **Communication** tab shown below. The IP address entered in the **Ip Address** field determines which Avenue frame is being targeted by this PC. Note that the AveNet address displayed in the **Virtual Module Server Avenet ID** field is not necessarily the AveNet address of the frame that this PC is targeting.

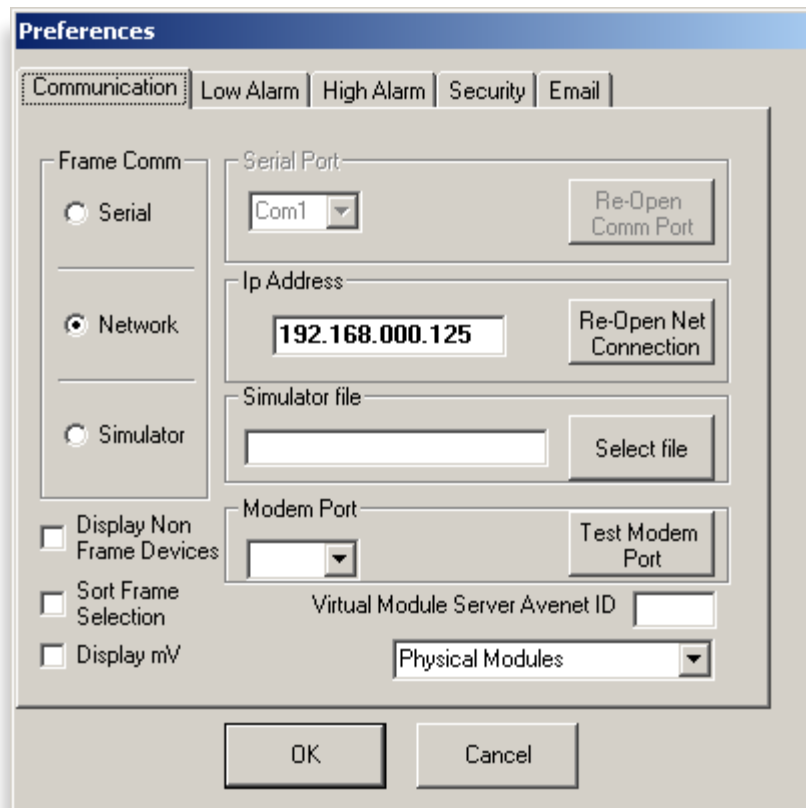

The AveNet address of the frame targeted by this PC can be found in the following locations:

- Under the **Frame** pulldown, select **Edit Configuration** to bring up the **Frame Configuration** screen. The AveNet address of the targeted frame is shown on the top right of the screen. In this example, the Avenet ID is 25.
- Another way to determine the AveNet address of the targeted frame is to list the frames by Address ID on the Mainscreen of Avenue PC. The targeted frame will appear at the top of the list identified by the AveNet IP address.

The screenshot shows a 'Frame Configuration' dialog box with the following fields and values:

Field	Value
Frame Name	Tech Writing
Frame Group	
Avenet ID	25
Software Version	2.2.14
IP address	192.168.0.125
Ker Version	KV 2.0.2b1
Pwr Supply 1	Normal Function
Pwr Supply 2	Normal Function
Master Ref	No Reference
Cooling	Normal
Frame Temp	34.5
Fan Drive	100
GPI Input	Open
Ethernet	Link
AveNet/IP	AVIP On
Lower Adr	25
Upper Adr	25
TCP Mismatch	4593

Buttons: OK, Cancel

## SNMP Monitoring

As of System Software version 2.2.0, the Ensemble Designs Avenue Signal Integration System added support for Simple Network Management Protocol (SNMP). This section provides an overview of this implementation.

Each Avenue device, the 3RU Frame, the 1RU Frame, and the Tabletop control panel all have 10Base-T Ethernet connectivity. As of version 2.2.0, all of these devices gain SNMP support. All installed Avenue systems are eligible for upgrade to this version. Systems that are running pre-version 2.0 software require a special upgrade process to update both the operating software and the boot kernel.

The implementation follows SNMP Version 1.0 as defined in RFC 1157. It is future compatible to SNMP Version 2.0.

The intent of this implementation is to provide users with a straightforward means to query system elements for status and fault identification. Because the Avenue product line contains more than 60 different signal processing modules, the number of MIBs (Management Information Base) required to support each individually becomes difficult to manage – from both the development and user side. Instead, a single MIB has been developed. This MIB provides visibility of the status and condition of the Frame, and individually the status of each of the signal processing modules in the frame.

Each Avenue Frame which is to be viewed through the SNMP interface must have its own Ethernet connection and IP address. Configuration of that connection, the IP address, subnet mask, and gateway address is performed in the same manner as for other network connectivity.

As of software version 2.2 for Avenue signal processing modules, the functions listed in the SNMP Function Table on the next page are provided.

For other modules, until such software is available, the SNMP implementation will provide some limited module status information. The module will report that it is one of the following:

- normal
- in kernel mode
- not installed

Traps are not supported.

### Upgrading For SNMP Monitoring

The file **5030v220b1.msf** or later must be loaded into the 5030 or 5035 Control Module to institute SNMP communications. The file for the current software version is **5030v2214.msf**. If you are already running 2.x.x software in the Control Module the software can be directly upgraded by using the Update Frame Software function in Avenue PC. For upgrade information, go to the Ensemble Designs web site at [www.ensembledesigns.com](http://www.ensembledesigns.com).

## SNMP Function Table

Function	Indicator	Possible Values	Notes
cpu Func	CPU status	Normal, Kernel, Fail	
powerSupply1	Power status	Normal, Failed, Not Installed	
powerSupply2	Power status	Normal, Failed, Not Installed	3RU Frame only
cooling	Cooling status	Normal, Failed	3RU Frame only
reference	Master Reference Status	Normal_525, Normal_625, None	
For each of the signal processing slots (10 in the 3RU frame, 3 in the 1RU frame), these status points can be viewed:			
status	Module status	Normal, Kernal, Not Installed	
signal	Signal status	Normal, Faulted, Unknown	This is a generalized indicator which reflects the input signals to a given module. It will indicate Faulted if any of the configured inputs to a module are missing.
reference	Reference status	Normal, Faulted, Unknown	

# Chapter 5: Operations

Control of Avenue modules can be performed locally with the front module controls on each module, remotely using an Express Panel, an Avenue Touch Screen Tabletop Control Panel, a panel installed in a 3RU frame or from a networked PC with the Avenue PC Application software.

## Local Operation

Local operation for individual modules is covered in each module's manual, available through our website.

## Avenue PC Operation

Remote control of Avenue frames and modules can be done with the Avenue PC Application software installed on a networked PC. All aspects of Avenue PC installation and operation are covered in the manual that accompanies the software.

## Avenue Express Panel Menus and Operation

Operation and configuration of the Avenue Express Control Panel is covered in its manual.

## Avenue Touch Screen Panel Menus and Operation

Operation of the Avenue Touch Screen in the Tabletop model and installed in the Avenue frame is covered in this chapter.

Remote control features of the Avenue Touch Screens include the following:

- Adjustment of module parameters
- Customizable module menus
- Setting user levels for security
- Creating quick keys for easy access to module settings and menus
- Locking modules for critical paths

The Avenue Touch Screens provide a series of menu displays to allow you to set AveNet and IP addresses, enable AveNet Over IP (AVIP), name and monitor modules, frames and groups of frames, set user security levels, and set module parameters in the system. Each system menu display is illustrated and explained in this section. The menus available for each individual Avenue module are given in the manual for each module available through our website.



## Home Menu

The top level **Home** menu is illustrated below. From this menu you can choose from the following:

- Select Frame/Module
- Virtual Modules
- Configuration

It is recommended to begin Avenue Touch Screen operation by calibrating the touch screen. Refer to the next section for instructions on calibration.

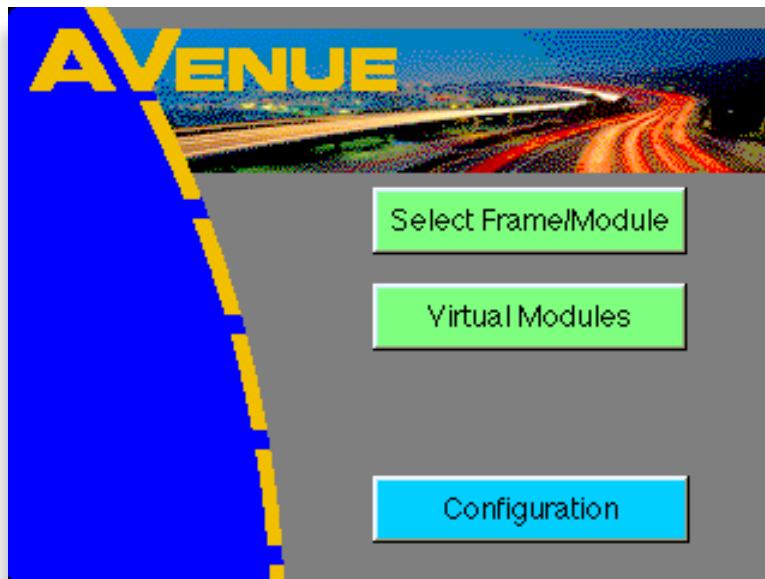

## Touch Screen Calibration and Adjustment

A Touch Screen may be calibrated for touch sensitivity and adjusted for brightness and contrast.

To perform touch sensitivity calibration, push the **Configuration** selection on the **Home** menu to bring up the **Configuration** menu shown below.

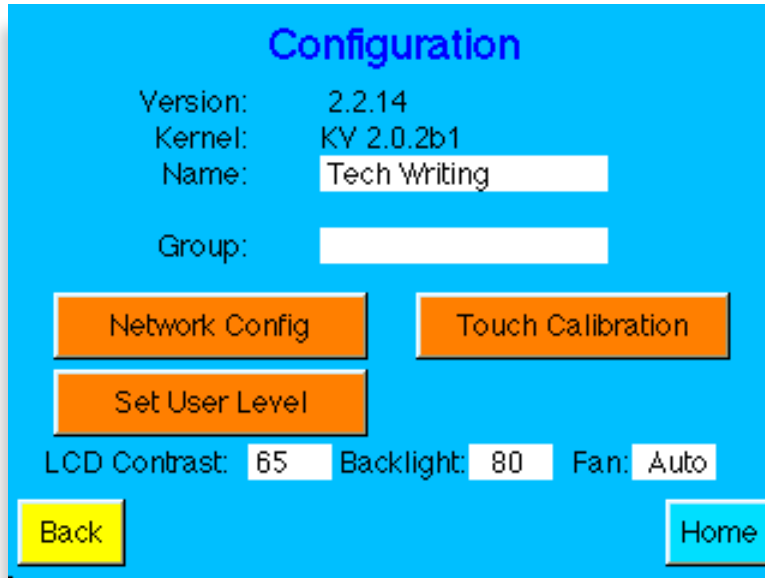

Press the **Touch Calibration** button to bring up the calibration menus. The first **Touch Calibration** screen will appear as shown below. Press the target (+) in the upper left hand corner of the screen to perform the first calibration step. As you press the target, a purple dot will appear in the target area to indicate the calibration has been performed.

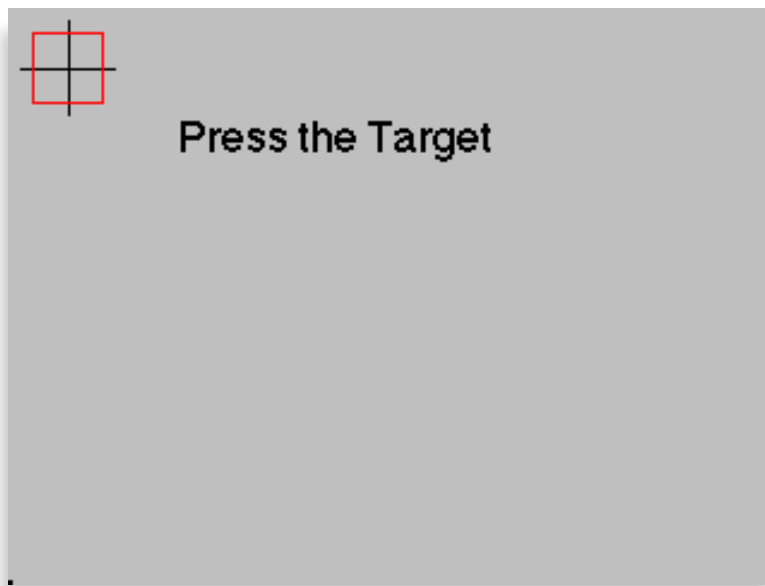

The next calibration menu will appear as shown below. Press the target (+) in the lower right hand corner. The purple dot will appear in the target when calibration is complete.



This will bring up the **Done** screen shown below. Your calibration is complete. To check screen sensitivity calibration, touch the screen in various spots and the purple dot should appear to verify the screen response.

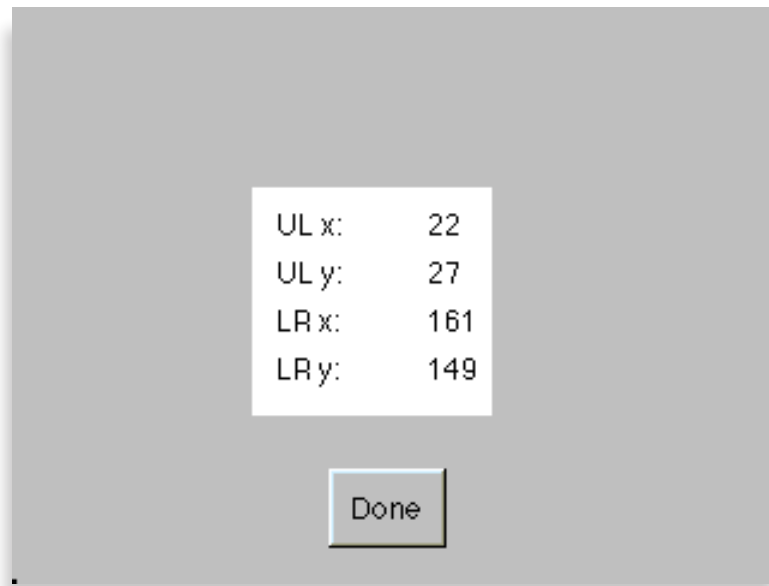

Press **Done** to return to the main **Configuration** menu. Select **Home** to return to the top level menu. If you experience problems with calibration or the Touch Screen does not seem to be working properly, refer to the **Avenue Touch Screen Troubleshooting** section at the end of this document for the reset procedure.

## Select Frame/Module Menu

From the **Home** menu, push the **Select Frame/Module** selection to access the frame and module information in the system. The menu will appear similar to the example below. The frames that are present on the network will appear with the name, group name and the AveNet address displayed for each frame. Pushing **Module** will bring up frame information about the first frame in the list. Use the **Back** button to go to the previous menu. Return to the top level menu by selecting **Home**.

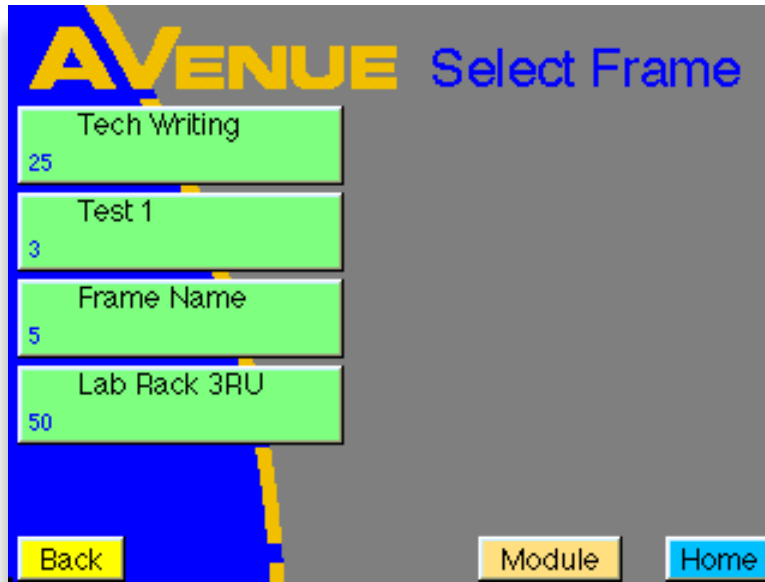

Information for up to ten frames will appear on one screen as shown below. If there are more than ten frames in the network (up to 1000 frames can be installed), you can scroll to the next screen with the **Up** arrow shown in the menu below. Move between screens with the **Up** and **Down** arrows.

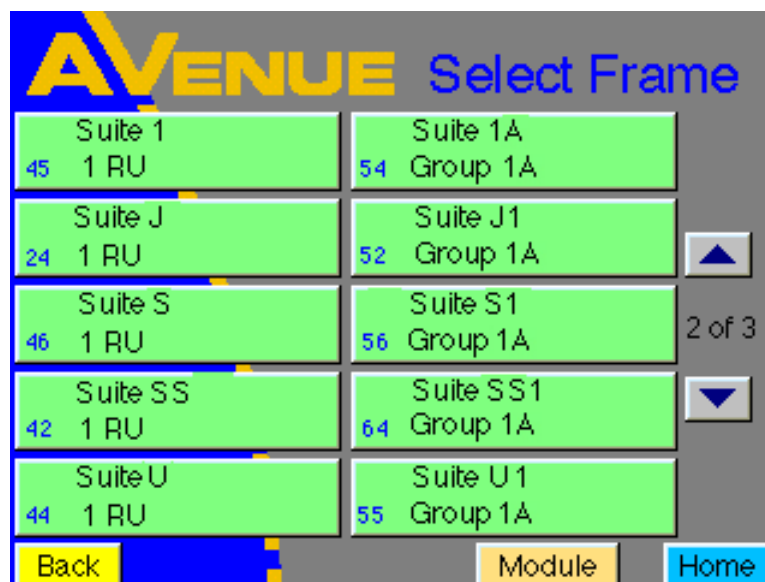

To bring up information about a particular frame, including the list of modules installed, push the frame selection directly from the **Select Frame** menu. This menu, shown below, will list each module in the frame by slot number, assigned module name, module type and group name.

This menu also provides a **Frame Controller Information** menu for the System Control module installed in the frame and other frame status items. Press the "i" in the upper right hand corner of the screen to bring up the **Frame Controller Information** menu.

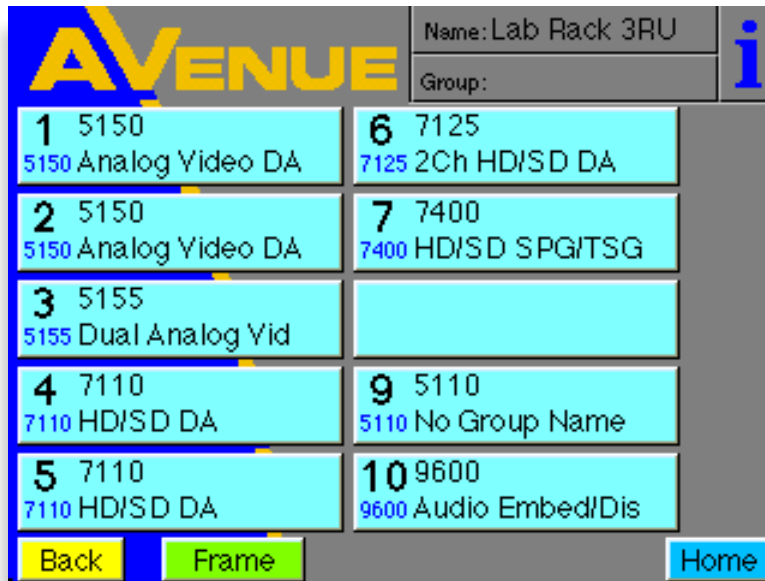

With the Frame Controller Information menu, you can enter a Name and a Group for the frame, and read Frame Status information.

To enter or change a frame name or group name, press either the **Name** or **Group** field to bring up the alphanumeric keypad. Names can be up to 15 characters including spaces. For a capital letter, push the **SHIFT** key first, then select the letter from the keyboard. Use the **DEL** key to backspace and clear the display. Press **ENTER** to finalize your selection and return to the frame or module information screen, or press **Cancel** to return to the **Frame Controller Information** menu with no changes.

Use the arrows to scroll through the following Frame Status items:

- Software version
- IP Address
- Ker Version (kernel version of the operating system)
- Power Supply 1 (option) status
- Power Supply 2 status
- Master Reference
- Cooling (fan state)
- Frame Temp (in degrees centigrade)
- Fan Drive (percentage of fan speed being utilized)
- GPI Input (Open or Closed)
- Ethernet
- AveNet/IP (On or Off)
- Lower Adr (lowest AveNet address of frame in network)
- Upper Adr (highest AveNet address of frame in network)
- TCP Mismatch (factory use only)

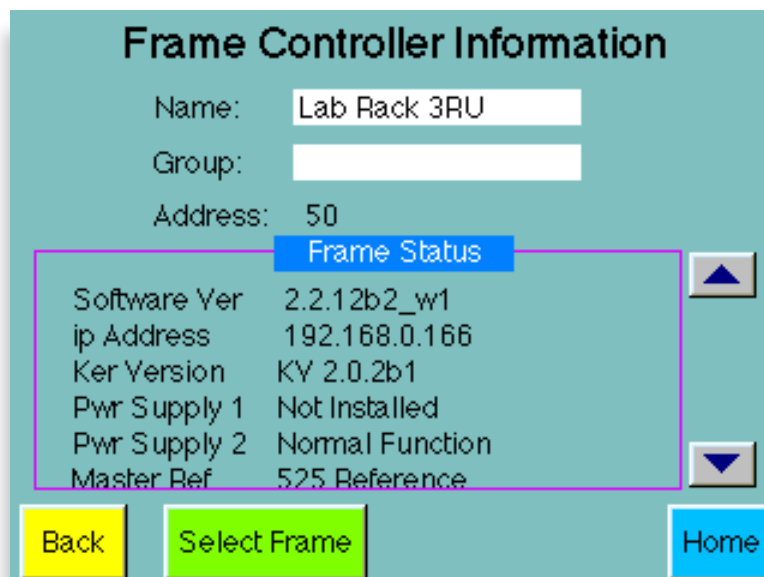

To access a module in the frame, select the module directly from the module list shown earlier. For example, pushing Module 7 in the module list will bring up the 7400 module menu shown in the figure below. These menus allow you to set module parameters from the Touch Screen. The menus for each type of module are illustrated and outlined in each individual module manual.

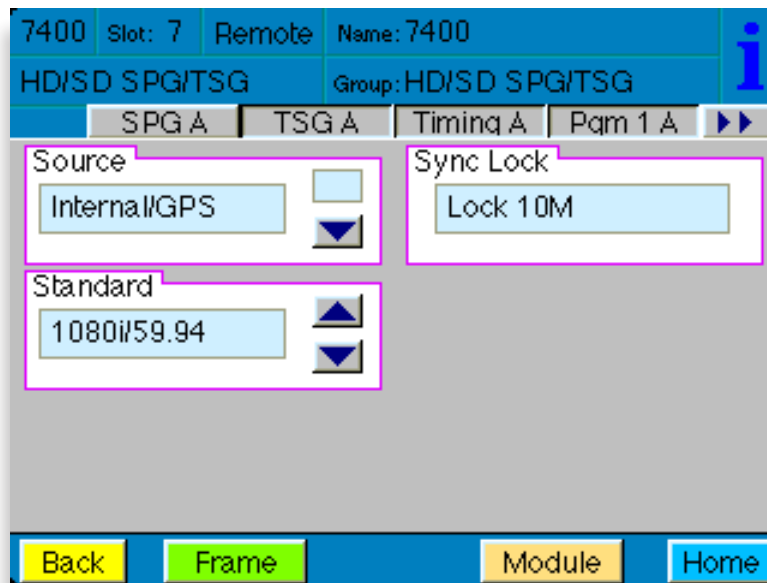

When using a Tabletop Touch Screen Control Panel, module menu adjustments can also be made using the external knobs on the control panel. Module menus with this capability will appear with blue arrows on the sides of each menu to indicate that the parameter may also be set with the external controls as shown in the menu example below.

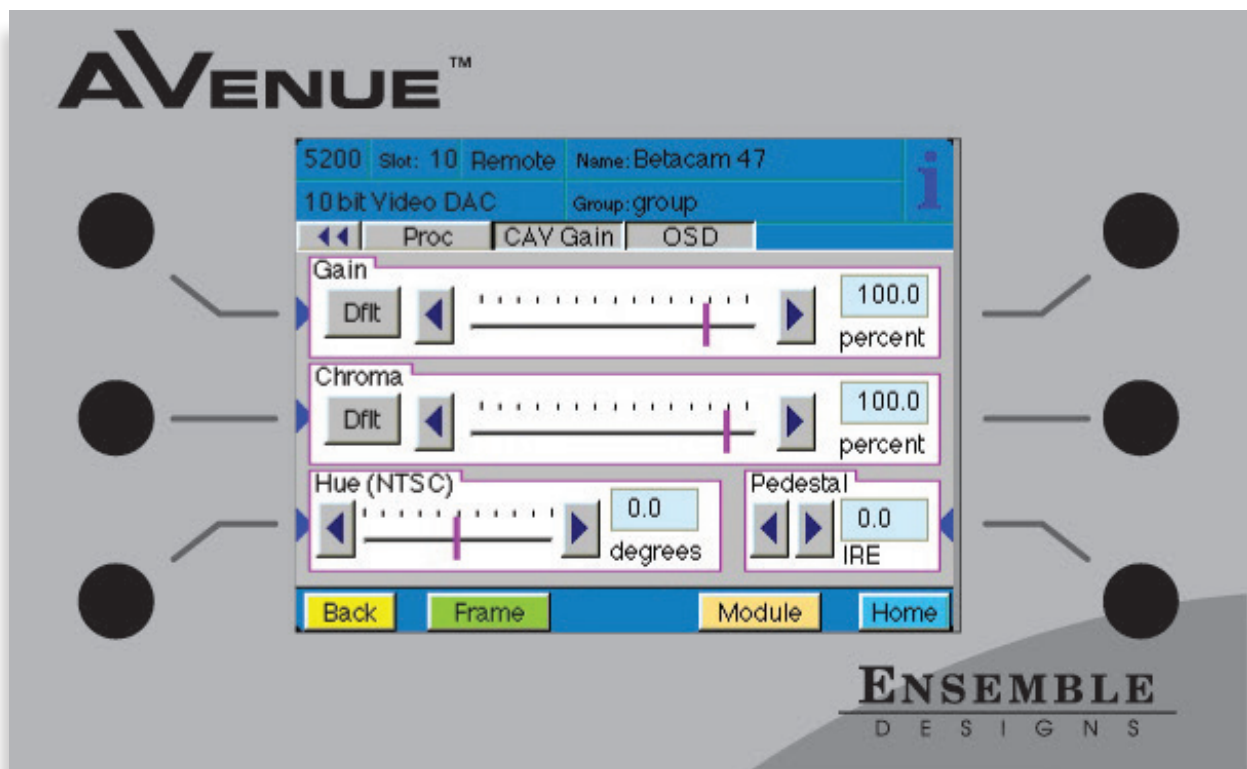

Pressing any of the fields for setting numeric parameters will bring up the **Number Pad** shown earlier. Use the **Number Pad** to enter parameters. Press **Enter** to finalize the value. Press **Cancel** to close the screen with no changes. Or use the **Default** key to enter the parameter default value and close the screen. Note that when parameter defaults are reached, the slider bar will turn purple to indicate this.

Each module menu also provides access to a **Module Information** screen. Press the “i” in the upper right corner of any module menu screen. This will bring up the **Module Information** screen as shown in the example below. This menu gives pertinent information on the type of module installed, in this case, a 7400 module. This includes the Model number, Function, Manufacturer, Serial Number, Software version, Hardware version of the module in addition to its location in the frame.

Push the **Name** or **Group** selection directly to bring up the **Keyboard** menu to change the name of the module or group.

For modules running software version 2.0 and later, a Module Lock Status selection is present for module lock functionality. A module can be put into one of three states:

1. **All Access** – module is open to all control points on the network (default).
2. **Locked** – module is locked out to all control points on the network.
3. **Adr#** – Control of the module is dedicated only to this specific control point. The AveNet address of this control point is displayed as an Avenet Address number (for example, Adr10). If another control point has dedicated control of this module already, its AveNet Address will be displayed. Dedicated control of a module can only be changed at a specific Touch Screen or PC control point having Administrator privileges.

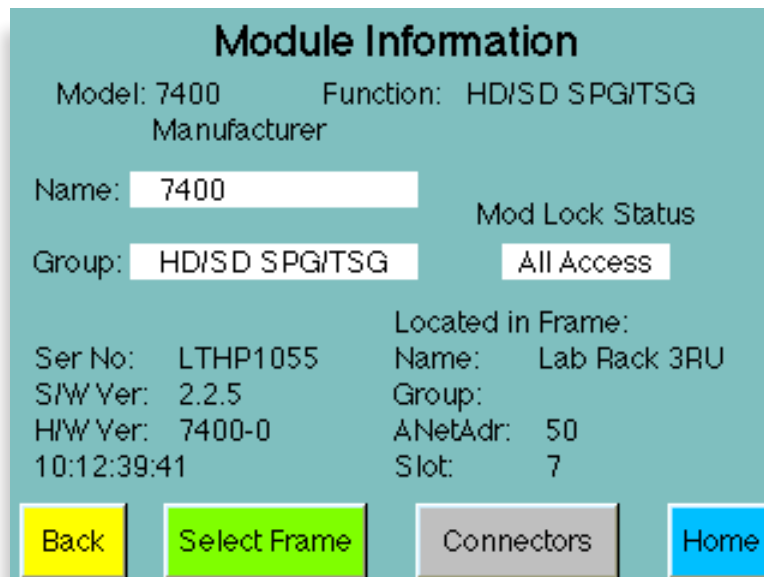



## Virtual Modules

Selecting the **Virtual Modules** button in the **Home** menu accesses any Virtual Modules located on the server selected in the Module Selection/Navigation area of the Network Configuration page explained on the next page. The Virtual Modules will be displayed in the same manner as Physical modules and all controls will be available for changing parameters.

Details of setting up and using Virtual Modules can be found in the Avenue PC Control Application Software manual.

## Configuration Menu

Selecting the **Configuration** button in the **Home** menu brings up the menu shown below, which displays the current software version and allows you to name the device and the group. It also provides access to the Network Config, Set User Level, and Touch Calibration menus, as well as the LCD Contrast, Backlight and Fan fields.

To enter or change a device name or group name, press either the **Name** or **Group** field in the **Configuration Menu** to bring up an alphanumeric keyboard pad.

To change a name, use the **DEL** key to backspace and clear the display. Use the keyboard to enter the name desired. Names can be up to 15 characters, including spaces. For a capital letter, push the **SHIFT** key first then select the letter from the keyboard.

Press **ENTER** to finalize your selection and return to the **Configuration Menu**. Press **Cancel** to return to the **Configuration Menu** without making any changes.

To adjust contrast and backlighting, use the fields **LCD Contrast** and **Backlight** on the Configuration screen. **Fan** can be set to Auto or Full.

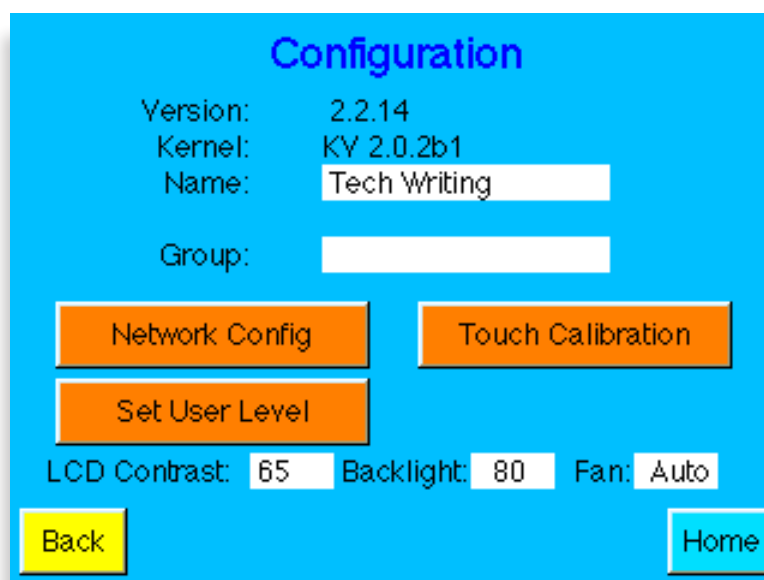

## Network Configuration Settings

Pressing the **Network Config** button in the **Configuration** menu brings up the Network Configuration menu (shown below) used to set the AveNet address, enable or disable AVIP, set the lower and upper AveNet address range and set the IP address information for the frame. Refer to [“Chapter 4: Networking”](#) on page 24 of this document for information on network configuration.

The screenshot shows the 'Network Configuration' menu with the following fields and options:

AveNet		Internet	
Address:	25	IP Address	192.168.0.125
AveNet over IP Routing	Enable	SubNet Mask	255.255.255.0
Local Range	Lower: 25	Gateway	0.0.0.0
	Upper: 25		
	<b>Distant</b>		
Module Selection / Navigation			
Module Type:	Phys & Vir	Server Avenet Adr:	1
<b>Back</b>		<b>Home</b>	

The **Module Selection/Navigation** section of the **Configuration** menu allows you to select what type of modules are going to be displayed on the module list for a frame. Two types of modules can exist in an Avenue frame.

Physical modules are those modules that are installed in any of the accessible frames in the network. Virtual Modules are groups of custom menus created with Avenue PC Software from modules present in any Avenue frame on the network. These groups of menus combine functionality from any number of different modules. If Virtual Modules have been created with Avenue PC, you can choose to view only these custom modules by selecting **Virtual Only**. View only Physical modules by selecting **Physical Only**. Select **Phys & Vir** to view both Physical and Virtual Modules.

The Server AveNet Adr field indicates the AveNet address of the frame which is acting as the server for storage of any Virtual Modules that have been created.

## Set User Levels

Pressing the **Set User Level** button in the **Configuration** menu brings up the User Level menu, shown below. This menu is used to set the security level of access to module parameters.

A User Level is assigned to each adjustable control parameter. These levels are assigned to a default according to adjustment type and whether it is in a critical path. The User Level for the parameter can be changed using the Avenue PC Application. User Levels are different for each module type and are listed in the manual for each specific module.

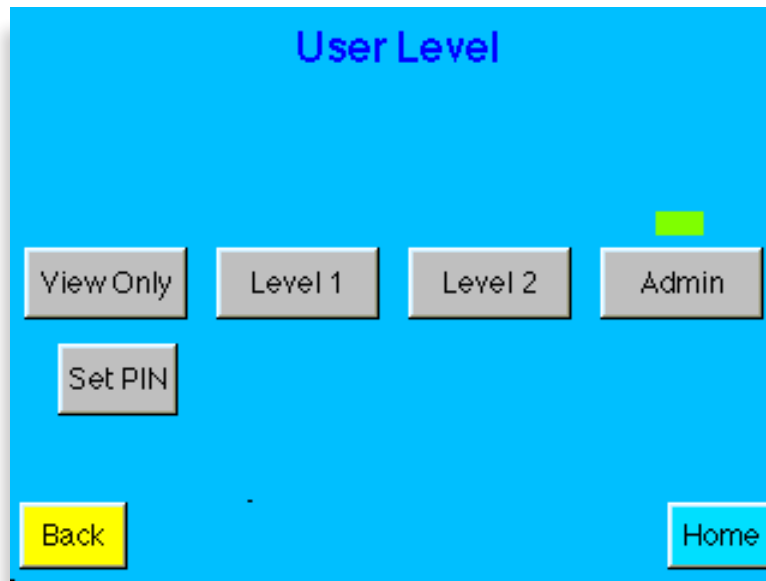

There are four User Levels: **Admin**, **Level 1**, **Level 2**, and **View Only**. User Levels can be protected by a four-digit pass code allowing the access of each level to be assigned to different functional groups in a facility. Some groups may need more expert level access to certain parameters while others require read-only access. Critical modules can also be locked out entirely or set so only a single control point has control access using the **Module Information** screen shown earlier or using Avenue PC.

To set a PIN pass code, select the **Set PIN** button, then enter a four-digit pass code in the keypad.

To revert to operation without a PIN number, the Administrator may enter 0000 for the four digit pass code and a PIN will no longer be required for this User Level.

## Avenue Touch Screen Troubleshooting

If the Avenue Touch Screen seems unresponsive or you are unable to run the calibration procedure from the screen, you may reset the Touch Screen.

### To Reset the Touch Screen on a 3RU Frame

1. Open the front panel and locate the 5030 System Control module.
2. From the 5030 front panel, navigate to the Touch Screen menu by pressing **S3** up or down sequentially until "Tch" displays on the Status Menu light panel. Tch is the seventh selection on the menu.
3. Press **S1** to the left once. The message "Press Ent to Reset Touch Panel" displays on the Status Menu. "Ent" refers to the **S4** button.
4. Press **S4**. "Rst!" displays for a moment. The Touch Screen is now reset to factory default calibration.
5. Enter the Configuration menu and run the Touch Calibration procedure again.

### To Reset the Touch Screen on a Tabletop Control Panel

Resetting the Tabletop Touch Screen will completely delete all information you have entered such as the IP and AveNet address and return it to factory default calibration.

1. Locate the recessed Reset button on the top right rear of the unit.
2. Press the recessed Reset button with a narrow tool and remove power to the unit.
3. Still holding the Reset, reapply power. The Touch Screen is now reset to factory default calibration. You will need to reassign IP and AveNet addresses from the Configuration menu as these have been cleared in the reset process.
4. Enter the **Configuration** menu and run the **Touch Calibration** procedure again. Until this calibration procedure is run, the Touch Screen responsiveness may appear out of alignment.
5. Reassign IP and AveNet addresses as applicable for the Tabletop Control Panel.

## Specifications

### Avenue 1RU Frame with 5010 Power Supply

#### Frame Dimensions

Height:	1RU, 1.75 inches / 44.5 mm
Width:	19 inches / 482.6 mm
Depth	13" / 330 mm
Weight (no modules)	11.2 lbs / 5.1 kgs

### Avenue 3RU Frame with 5020 Power Supply

#### Frame Dimensions

Height:	3RU, 5.25 inches / 133.4 mm
Width:	19 inches / 482.6 mm
Depth	15.1" / 383.6 mm
Weight (no modules)	26.5 lbs / 12.1 kgs

#### 5010/5020 Power Supply

AC Voltage Input:	85-264 VAC
Line Frequency:	47-63 Hz
Output Voltage:	+12 volts $\pm$ 0.5 volt @ 8 Amps -12 volts $\pm$ 0.5 volt @ 8 Amps
Protection:	Overvoltage, overcurrent and short circuit, overtemperature
Minimum Load:	0%
Fusing:	2 amp slo-blo on Line and Neutral
Efficiency:	80% minimum
Ambient Operating Temperature:	0 to 50 degrees C
Relative Humidity:	0-95% Condensing
Safety Standards:	Protections Class: 1 Overvoltage Class: II Pollution Degree: 2 UL CAN/CSA-C22.2 No. 950-M89 TUV EN60950 TUV VDE0805 CE Low Voltage Directive CB Report per IEC 950 (1991) 2nd Edition, A1, A2, plus national deviations

Due to ongoing product development, all specifications are subject to change.

## Warranty

This equipment is covered by a five year limited warranty. If you require service (under warranty or not), please contact Ensemble Designs and ask for customer service before you return the unit. This will allow the service technician to provide any other suggestions for identifying the problem and recommend possible solutions.

## Factory Service

If you return equipment for repair, please get a Return Material Authorization Number (RMA) from the factory first.

Ship the product and a written description of the problem to:

Ensemble Designs, Inc.  
Attention: Customer Service RMA #####  
870 Gold Flat Rd.  
Nevada City, CA. 95959 USA

(530) 478-1830  
Fax: (530) 478-1832

[service@ensembledesigns.com](mailto:service@ensembledesigns.com)  
<http://www.ensembledesigns.com>

Be sure to put your RMA number on the outside of the box.