

# EPIC® HA Series

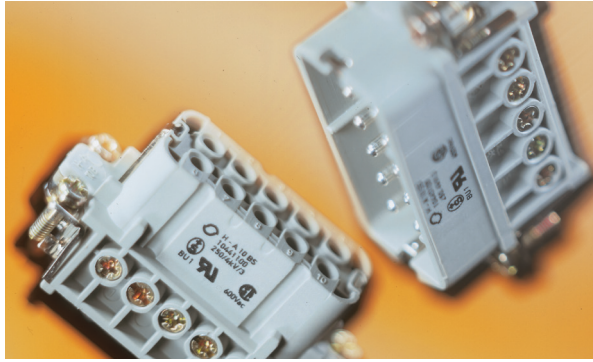

Similar to the HBE series inserts but more compact, EPIC® HA series inserts are used whenever space is limited. EPIC® HA 3/4 inserts and housings provide the smallest possible footprint in a 10A power connector. HA 10-48 inserts are unique because of their shortened ground straps, which still allow for a wire cross-section up to 2.5 mm<sup>2</sup>. HA 3-48 screw-terminated inserts fit into EPIC® HA series housings. A modified EPIC® HB 48 housing can fit 64 contacts.

## Technical Data

<b>Number of Contacts:</b>	3, 4, 10, 16, 32, 48, 64 (+PE)	<b>Rated Current:</b>	
<b>Temperature Range:</b>	-40°C to +100°C	- UL:	
- Short-term:	up to +125°C	- EPIC® HA 3/4:	10A
<b>Pollution Level:</b>	3	- EPIC® HA 10-64:	14A
<b>Dimensioning Transient:</b>	4 kV	- CSA:	
<b>Mating Cycles:</b>	- Per DIN EN 61984:2008 Service Life Test: Tested to 100 cycles and passed - Per Contact Thermal Test: Useful service up to 500 cycles is possible at rated voltage and current*	- EPIC® HA 3/4:	10A
<b>Test Voltage:</b>	4 kV	- EPIC® HA 10-64:	16A
<b>Rated Voltage:</b>		- IEC:	
- UL:	600V	- EPIC® HA 3/4:	10A
- CSA:	600V	- EPIC® HA 10-64:	16A
- IEC:		- SEV:	16A
- EPIC® HA 3/4:	400V	<b>Wire Size:</b>	
- EPIC® HA 10-64:	250V	- EPIC® HA 3/4:	
- SEV:	250V	- solid or stranded wire with ferrule:	20-14 AWG (0.5-2.5 mm <sup>2</sup> )
		- EPIC® HA 10-64:	
		- solid or stranded wire with ferrule:	20-14 AWG (0.5-2.5 mm <sup>2</sup> )
		- for stranded wire without ferrule:	18-14 AWG (0.75-2.5 mm <sup>2</sup> ) (requires insert with wire protection)
		<b>Contact Material:</b>	Silver-plated copper alloy
		<b>Contact Resistance:</b>	1.5-4 mΩ

\* In dry, non-conductive, non-corrosive environments when protected in a housing rated at least IP54 and disconnected for cycling and maintenance only.

## EPIC® HA Inserts: Derating Curves

EPIC® HA Screw-Terminated  
16 AWG (1.5 mm<sup>2</sup>)

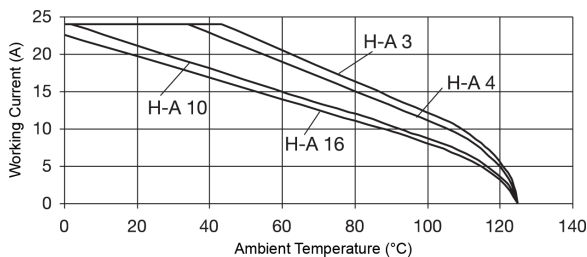

EPIC® HA Screw-Terminated  
14 AWG (2.5 mm<sup>2</sup>)

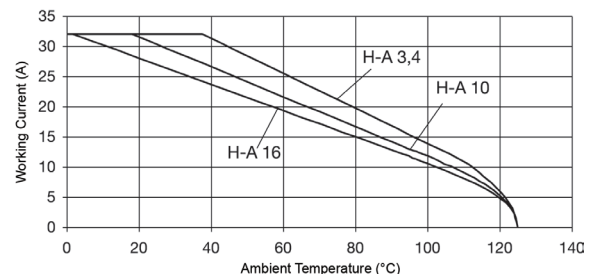

EPIC® HA 3 Inserts  
Screw-Terminated

View from Cable Side

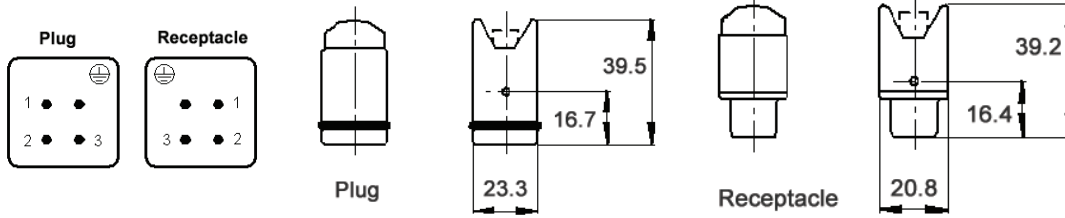

All dimensions are in mm.



Approvals



**Complete the Installation**

	HA 3/4: page 400		Coding Pin: 10451400
---	---------------------	---	-------------------------

Description	Plug	Receptacle
Screw-Terminated	10420000	10421000

EPIC® HA 4 Inserts  
Screw-Terminated

View from Cable Side

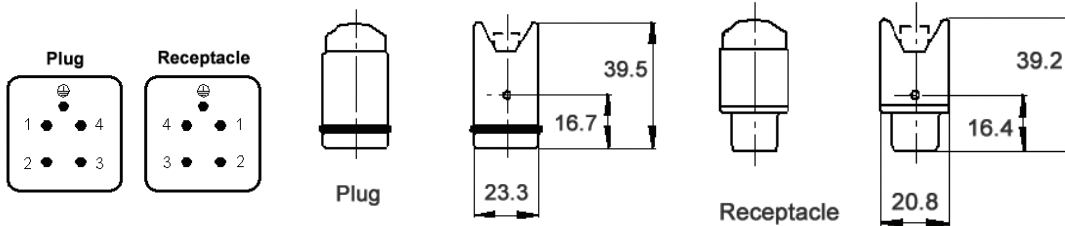

All dimensions are in mm.



Approvals



**Complete the Installation**

	HA 3/4: page 400		Coding Pin: 10451400
---	---------------------	---	-------------------------

Description	Plug	Receptacle
Screw-Terminated	10431000	10432000

EPIC® HA 10 Inserts  
Screw-Terminated

View from Cable Side

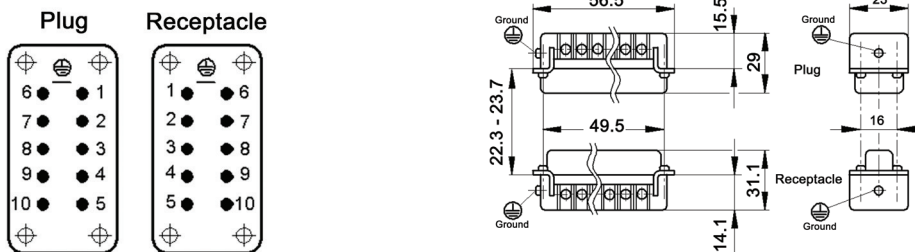

All dimensions are in mm.



Approvals



**Compatible Housing**

	HA 10: page 402
---	--------------------

Description	Plug	Receptacle
Screw-Terminated with Wire Protection	10440100	10441100
Screw-Terminated without Wire Protection	10440000	10441000

Photographs are not to scale and are not true representations of the products in question. For current information go to our website. If not otherwise specified, all values relating to the product are nominal values.

# EPIC® HA 16 Inserts

## Screw-Terminated

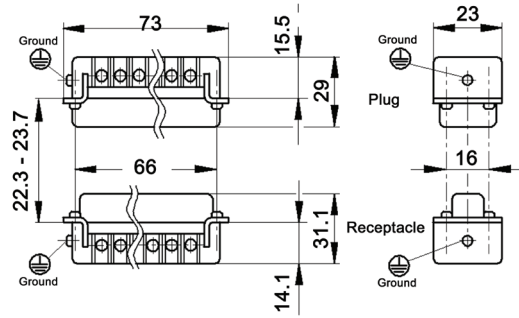
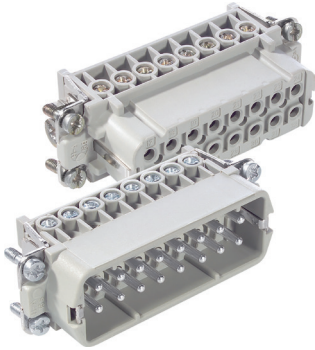

All dimensions are in mm.

View from Cable Side

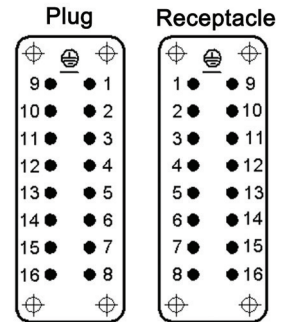

Description	Plug	Receptacle
Screw-Terminated with Wire Protection	10530000	10531000
Screw-Terminated without Wire Protection	10532000	10533000

**Compatible Housing**

HA 16:  
page 404

**Approvals**



# EPIC® HA 32 Inserts

## Screw-Terminated

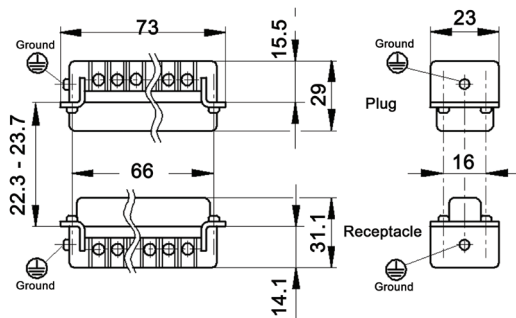
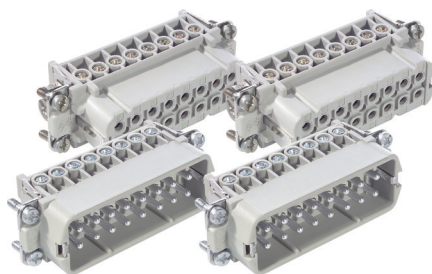

All dimensions are in mm.

View from Cable Side

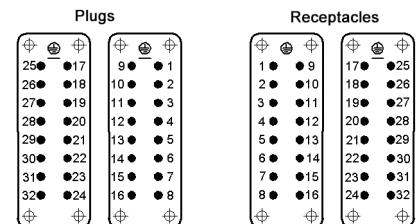

Description	Contacts	Plug	Receptacle
Screw-Terminated with Wire Protection	#1 - 16	10530000	10531000
	#17 - 32	10540000	10541000
Screw-Terminated without Wire Protection	#1 - 16	10532000	10533000
	#17 - 32	10542000	10543000

**Compatible Housing**

HA 32:  
page 406

**Approvals**



Photographs are not to scale and are not true representations of the products in question. For current information go to our website. If not otherwise specified, all values relating to the product are nominal values.

# EPIC® HA 48 Inserts

## Screw-Terminated

View from Cable Side

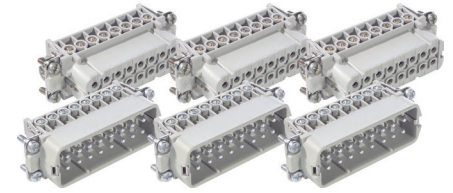
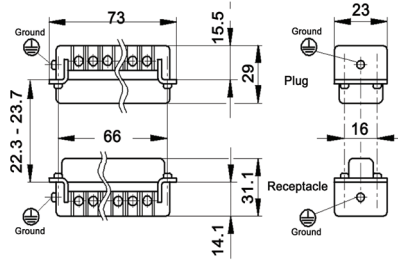
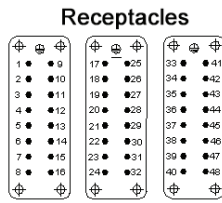
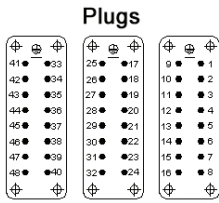

All dimensions are in mm.

### Approvals



### Compatible Housing



HA 48:  
page 408

Description	Contacts	Plug	Receptacle
Screw-Terminated with Wire Protection	#1 - 16	10530000	10531000
	#17 - 32	10540000	10541000
	#33 - 48	10540100	10541100
Screw-Terminated without Wire Protection	#1 - 16	10532000	10533000
	#17 - 32	10542000	10543000
	#33 - 48	10542100	10543100

View from Cable Side

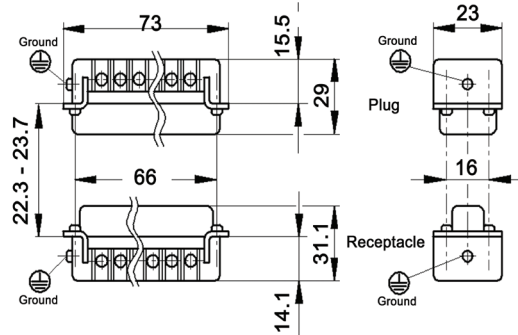
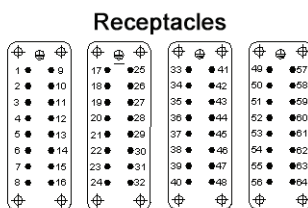
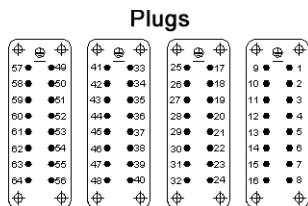

All dimensions are in mm.

# EPIC® HA 64 Inserts

## Screw-Terminated



### Approvals



### Compatible Housing



HA 64:  
page 409

Description	Contacts	Plug	Receptacle
Screw-Terminated with Wire Protection	#1 - 16	10530000	10531000
	#17 - 32	10540000	10541000
	#33 - 48	10540100	10541100
	#49 - 64	105300LE64	105310LE64

Photographs are not to scale and are not true representations of the products in question.  
For current information go to our website. If not otherwise specified, all values relating to the product are nominal values.