

## F Connectors

This type is used in such applications as home television receivers for cable television (CATV) systems.

### FP-C Series (Straight Plug, Crimp Type)

Model	Suitable Cable		Center Pin	Sleeve	Boot	Die Set
	Canare	Belden (suggested)				
FP-C25HD	L-2.5CHD	—	BN1003B	★ BN7129	—	TCD-35CA
FP-C3	L-3C2VS, L-3C2V, V*-3C	—	BN1002B	BN7003A	CB24	TCD-35CA
FP-C31	L-3C2W	—	BN1002B	★ BN7011	CB25	TCD-31C
FP-C3F	L-3CFB, LS-3CFB, V*-3CFB	—	BN1003B	BN7003A	CB24	TCD-35CA
FP-C4	LV-61S	8241, 8279, RG-59B/U	BN1003B	BN7015A	CB25	TCD-4CA, TCD-451CA
FP-C4F	L-4CFB, LS-4CFB, V*-4CFB	1505A, 8212, 8241F, 9167, 9259, 9659	BN1004B	BN7015A	CB25	TCD-4CA, TCD-451CA
FP-C5	L-5C2VS, L-5C2V, V*-5C	—	BN1004B	BN7016	CB26	TCD-35CA
FP-C52	L-5C2W	—	BN1004B	★ BN7014	—	TCD-451CA
FP-C53A	L-4.5CHD	1694A, 9066, 9116, 9118, 9248	BN1005B	★ BN7046	CB26	TCD-35CA
★ FP-C55A	—	1695A, 89120, 87120, 633948, 9116P	BN1005B	★ BN7045A	—	TCD-35CA
FP-C5F	L-5CFB, LS-5CFB, V*-5CFB	—	BN1005B	B75004A	CB26	TCD-5CF, TCD-55FA
★ FP-C71A	—	7731A, 9064, 9292, 1617A, 9011	★ BN1041A	★ BN7021A	—	TCD-7CA
FP-C7FA	L-7CFB	—	★ BN1030A	★ BN7021A	—	TCD-7CA

•Standard package (20pcs / 100pcs)

★Production by order. Please ask us for ordering lot.

- Lock mechanism improves reliability by preventing shifting or detaching of the center pin.
- The tools and cable stripper can be used for the Canare crimp BNC plugs as well, thus saving on extra equipment.
- VSWR of 1.1 or less up to 2GHz. Compatible with broadcast satellite (BS) and communications satellite (CS) signals.
- Designed for indoor use.

Be sure to use the Canare crimping tool for installing connectors on cables.

### F Panel Mount Receptacles

Model	Description
FJ-JR	Jack to Jack
FJ-FPC	PC Board Straight Mount

•Standard package (20pcs / 100pcs)

- VSWR of 1.1 or less up to 2GHz. Compatible with broadcast satellite (BS) and communications satellite (CS) signals. <Fig. 1>
- For insulation from the panel, use insulation bushing IU-7/16. (Panel thickness: 1.2~3.0mm)

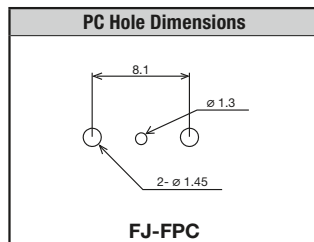
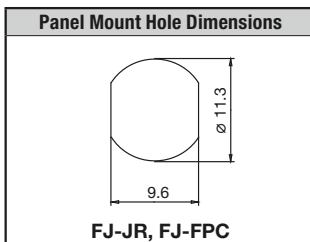

### F Recessed Bulkhead Receptacles

Model	Description
FJ-JRU	Jack to Jack
FJ-JRUD	Jack to Jack, Neutrik D Type
FJ-JRUDB	Jack to Jack, Neutrik D Type (Black)

•Standard package (20pcs / 100pcs)

- Two types of flange are available: ITT XLR F77 and Neutrik D compatible.

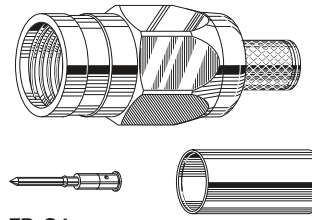

FP-C4

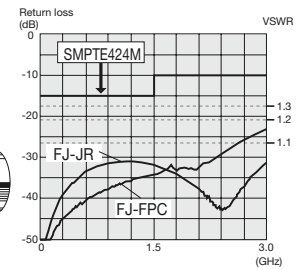
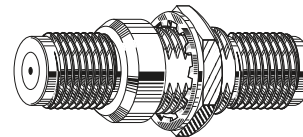
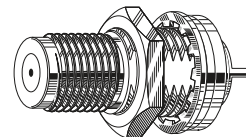

Fig.1 Return loss for FJ-FPC and FJ-JR



FJ-JR



FJ-FPC

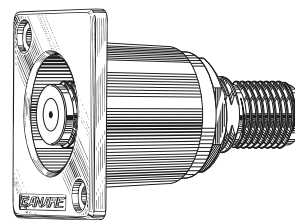
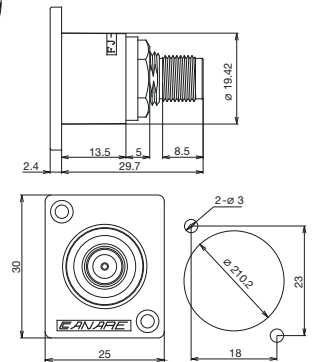

FJ-JRU

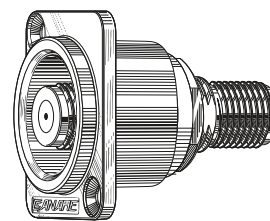
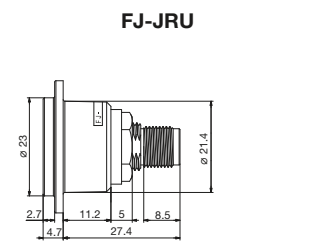

FJ-JRUD

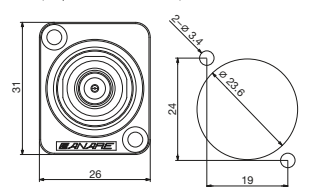

FJ-JRUD