



**Harbour**  
INDUSTRIES

# RF Microwave Coaxial Cable



**Spiral Strip**

**Strip Braid**

**Low Loss**

**MIL-DTL-17**

*Communications*



*Aerospace*



*Test Leads*

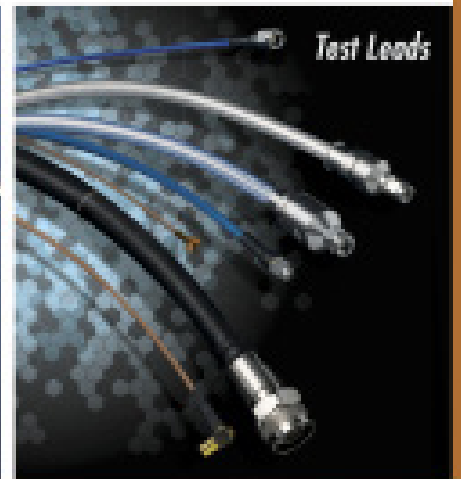



Harbour Industries LLC is the preeminent manufacturer of high temperature and high performance coaxial cables for the military, aerospace, commercial, and industrial markets. Design and process engineering expertise ensure high quality and uniform products in accordance with customer specifications. Harbour Industries has a wide range of manufacturing processes with large scale production operations and “First-in-Class” customer service.

Harbour manufactures QPL approved MIL-DTL-17 Coax cables swept for VSWR to ensure product uniformity. For many years, Harbour has also been manufacturing special versions of MIL-DTL-17 cables such as HS High Strength and TRX Triaxial constructions to meet demanding customer requirements.

In the 1980’s and 1990’s, Harbour developed a series of LL Low Loss, SB Strip Braid, and SS Spiral Strip series of coaxial cables for the RF and Microwave markets. Techniques such as composite strip braid configurations and proprietary expanded PTFE tape dielectrics were developed, thereby creating a cost effective viable source of supply for assembly houses and OEMs.

Moving into the 21st century, through the use of special materials and innovative construction techniques, Harbour continues to enhance their product offering with coaxial cables that are lighter weight, more flexible, and have higher levels of shielding effectiveness. Explore Harbour’s catalog for just a few of the cables offered.

Harbour is an ISO 9001-2008 manufacturer with facilities that are fully compliant to the directives of RoHS, REACH, DFARS, WEEE, ELV and BFR.



Harbour Industries Facility in Shelburne, Vermont.



*U.S. Toll Free (800)659-4733  
Phone (802)985-3311  
Canada Phone (450)293-5304  
[www.harbourind.com](http://www.harbourind.com)  
e-mail: [sales@harbourind.com](mailto:sales@harbourind.com)*

# COAXIAL CABLES

LL (Low Loss) Cables solid center conductor.....	page 4-5
Expanded PTFE tape dielectrics and composite braided shields	
LL (Low Loss) Cables stranded center conductor.....	page 6-7
Expanded PTFE tape dielectrics and composite braided shields..	
SB (Strip Braid) Cables .....	page 8-9
Solid PTFE dielectrics and composite braided shields	
SS Rock SStable® Spiral Strip Cables .....	page 10-11
Solid PTFE dielectrics and spiral strip shields	
HF High Frequency Coax Cable .....	page 12-14
LL, SB, and SS cables with guaranteed attenuation and VSWR performance up to 40GHz	
SFL Rock SStable® Spiral Flex Cables .....	page 15-16
More flexible version of SS cables	
SBF Rock SStable® Strip Braid Flex Cables .....	page 17-18
For continuous and long term flexing (flex life)	
MIL-DTL-17 Cables .....	page 19-20
QPL approved constructions	
HS (High Strength) & TRX (Triaxial) Cables .....	page 21
Phase Stability Over Temperature.....	page 22
Power Handling Chart.....	page 23-25
Phase Stability Over Flexure .....	page 26
VSWR and Return Loss .....	page 27
Power vs Temperature Derating Factors.....	page 28
Attenuation vs Temperature Correction Factor.....	page 29
Shielding Effectiveness Test Method.....	page 30-34

# LL (Low Loss) Coaxial Cable

## -solid center conductors



### Construction:

Center Conductor: Solid silver plated copper  
 Dielectric: Expanded PTFE tape  
 Inner Braid: Flat silver plated copper strip  
 Interlayer: Aluminum polyester or polyimide tape  
 Outer Braid: Round silver plated copper  
 Jacket: FEP, translucent colors, solid colors or clear

Operating temperature -55 +200° C

Velocity of Propagation 80%-83%

Impedance 50 Ohms

Capacitance 25.0 pF/ft

Shielding Effectiveness <-95 dB

	LL120	LL160	LL142	LL235	LL335	LL335i
Center conductor diameter	.0286"	.0403"	.051"	.057"	.089"	.089"
Dielectric diameter	.080"	.110"	.145"	.160"	.250"	.250"
Diameter over inner braid	.086"	.116"	.152"	.170"	.255"	.255"
Diameter over interlayer	.092"	.122"	.158"	.175"	.261"	.261"
Diameter over outer braid	.108"	.140"	.178"	.191"	.280"	.277"
Overall diameter	.120"	.160"	.195"	.235"	.332"	.300"
Weight(lbs/mft)	17	28	44	48	100	76
Bend radius	0.6"	0.8"	1.0"	1.2"	1.7"	1.5"
Attenuation (dB/100ft) @	<b>Typ</b>	<b>Typ</b>	<b>Typ</b>	<b>Typ</b>	<b>Typ</b>	<b>Typ</b>
400 MHz	8.3	6.3	4.7	4.2	2.9	2.9
1 GHz	13.1	10.0	7.5	6.7	4.6	4.6
2 GHz	18.7	14.3	10.7	9.6	6.6	6.6
3 GHz	23.0	17.7	13.2	11.9	8.2	8.2
5 GHz	29.9	23.1	17.2	15.5	10.8	10.8
10 GHz	42.8	33.4	24.9	22.5	15.8	15.8
18 GHz	58.2	46.0	34.2	31.0	21.9	21.9

See HF Low Loss Coax product pages for LL160-40GHz and LL142-26GHz cables with guaranteed attenuation and VSWR performance at frequencies above 18GHz.

# LL (Low Loss) Coaxial Cable

## -solid center conductors

### Unique cable design

The braid configuration and the expanded PTFE dielectrics of the LL cable constructions contribute to lower attenuation levels at higher frequencies, while providing shielding effectiveness levels that exceed those of flexible MIL-DTL-17 cables. Flat strips of silver plated copper are braided over the dielectric core with an intermediate metallized polyester or polyimide layer, and an outer round wire braid.

### Excellent electrical characteristics

All of Harbour's LL cables with expanded PTFE dielectrics exhibit low coefficients of expansion over the entire operating temperature range from -55° C to +200° C. Impedance discontinuities are minimized at the cable-to-connector interface. Higher levels of power can be transmitted because higher temperatures do not affect the cable due to the thermal stability of the tape. Where phase versus temperature requirements are critical, Harbour's LL cables allow for an approximately 75% lower phase shift and change in propagation time delay due to temperature. Temperature cycling tests have been performed on a number of Harbour's cables with positive results.

### Lowest attenuation for any given size

Harbour's LL coaxial cables, with expanded PTFE dielectrics and strip braid composite configurations, offer attenuation from 20 to 35% below other mil spec cables of comparable size. When size and weight are considerations, Harbour's LL cables should be specified.

### Attenuation Calculation and K Factors

Although typical and maximum attenuation values are given for discrete frequencies, typical attenuation values may be calculated by using K1 and K2 factors for each construction. The K1 factor is calculated by taking into consideration the type, strand factor, and diameter of the center conductor, and the impedance of the cable. The K2 factor is calculated by taking into consideration the velocity of propagation and the dissipation factor of the dielectric.

### Formula for Calculating Attenuation using K Factors:

$$\text{Attenuation (dB/100 ft) at any frequency (MHz)} = (\text{K1} \times \sqrt{\text{frequency}}) + (\text{K2} \times \text{frequency})$$

	LL120	LL160	LL142	LL235	LL335/LL335i
K1	.410	.309	.231	.207	.141
K2	.0001785	.00025	.0001785	.0001785	.0001674

# LL (Low Loss) Coaxial Cable

## -stranded center conductors

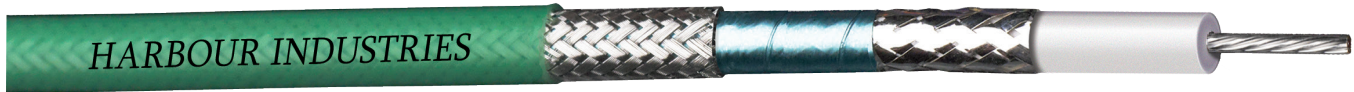

### Construction:

- Center Conductor: Stranded silver plated copper
- Dielectric: Expanded PTFE tape
- Inner Braid: Flat silver plated copper strip
- Interlayer: Aluminum polyester or polyimide tape
- Outer Braid: Round silver plated copper
- Jacket: FEP, translucent colors, solid colors or clear

Operating temperature -55 +200° C

Velocity of Propagation 80%-83%

Impedance 50 Ohms

Capacitance 25.0 pF/ft

Shielding Effectiveness <-95 dB

	LL142STR	LL270STR	LL450STR	LL480STR
Center conductor diameter	.051" (7/.017")	.068" (7/.023")	.133" (7/.048")	.160" (7/.054")
Dielectric diameter	.138"	.185"	.360"	.420"
Diameter over inner braid	.146"	.195"	.368"	.432"
Diameter over interlayer	.152"	.200"	.374"	--
Diameter over outer braid	.168"	.220"	.394"	.452"
Overall diameter	.195"	.270"	.450"	.480"
Weight(lbs/mft)	42	70	175	197
Bend radius	1.0"	1.4"	2.5"	2.7"
Attenuation (dB/100ft) @	<b>Typ</b>	<b>Typ</b>	<b>Typ</b>	<b>Typ</b>
400 MHz	6.0	4.1	2.3	1.9
1 GHz	9.5	6.6	3.7	3.1
2 GHz	13.5	9.5	5.3	4.5
3 GHz	16.6	11.6	6.6	5.6
5 GHz	21.7	15.1	8.7	7.5
10 GHz	31.2	21.8	12.8	11.2
18 GHz	42.7	29.9	-	-

See HF Low Loss Coax product pages for LL160-40GHz and LL142-26GHz cables with guaranteed attenuation and VSWR performance at frequencies above 18GHz.



# LL (Low Loss) Coaxial Cable

## -stranded center conductors

### Flexibility with stranded center conductors

Harbour's Low Loss coax designs with stranded center conductors are more flexible than similar designs with solid center conductors. Low loss cables with stranded center conductors exhibit attenuation slightly higher than comparable solid center conductor designs; however, unique composite braid configurations and expanded PTFE dielectrics result in attenuation lower than MIL-DTL-17 cables of comparable size. Shielding effectiveness levels also exceed those of flexible MIL-DTL-17 constructions.

### Excellent electrical characteristics

All of Harbour's LL cables with expanded PTFE dielectrics exhibit low coefficients of expansion over the entire operating temperature range from -55° C to +200° C. Impedance discontinuities are minimized at the cable-to-connector interface. Higher levels of power can be transmitted because higher temperatures do not affect the cable due to the thermal stability of the tape. Where phase versus temperature requirements are critical, Harbour's LL cables allow for an approximately 75% lower phase shift and change in propagation time delay due to temperature. Temperature cycling tests have been performed on a number of Harbour's cables with positive results.

### Attenuation Calculation and K Factors

Although typical and maximum attenuation values are given for discrete frequencies, typical attenuation values may be calculated by using K1 and K2 factors for each construction. The K1 factor is calculated by taking into consideration the type, strand factor, and diameter of the center conductor, and the impedance of the cable. The K2 factor is calculated by taking into consideration the velocity of propagation and the dissipation factor of the dielectric.

### Formula for Calculating Attenuation using K Factors:

$$\text{Attenuation (dB/100 ft) at any frequency (MHz)} = (\text{K1} \times \sqrt{\text{frequency}}) + (\text{K2} \times \text{frequency})$$

	LL142STR	LL270STR	LL450STR	LL480STR
K1	.294	.204	.112	.091
K2	.0001785	.000143	.00016	.00021

# SB (Strip Braid) Coaxial Cable



**Construction:**

- Dielectric: solid PTFE
- Inner braid: flat silver plated copper strip
- Interlayer: aluminum polyimide or polyester tape
- Outer braid: round silver plated copper
- Jacket: FEP, translucent colors, solid colors or clear

- Operating temperature: -55 +200° C
- Velocity of Propagation: 70%
- Impedance: 50 Ohms
- Capacitance: 29.4 pF/ft
- Shielding Effectiveness: <-95 dB

	SB316	SB142	SB142i	SB400	SB304	SB393
Center conductor	SCCS	SCCS	SCCS	SPC	SCCS	SPC
Center conductor diameter	.020" (7/.0067")	.037" Solid	.037" Solid	.0385" (19/.008")	.059" Solid	.094" (7/.031")
Dielectric diameter	.060"	.117"	.117"	.116"	.185"	.285"
Diameter over inner braid	.067"	.128"	.128"	.126"	.195"	.295"
Diameter over interlayer	.072"	.133"	.133"	.132"	.201"	.301"
Diameter over outer braid	.088"	.152"	.149"	.152"	.221"	.325"
Overall diameter	.098"	.195"	.172"	.195"	.280"	.390"
Weight (lbs/mft)	12	40	40	47	77	155
Bend radius	0.5"	1.0"	0.9"	1.0"	1.4"	2.0"
Attenuation (dB/100 ft) @	<b>Typ</b>	<b>Typ</b>	<b>Typ</b>	<b>Typ</b>	<b>Typ</b>	<b>Typ</b>
400 MHz	14.5	6.4	6.4	6.8	5.0	3.8
1 GHz	23.3	10.5	10.5	11.1	8.3	6.4
2 GHz	33.5	15.5	15.5	16.2	12.3	8.5
3 GHz	41.6	19.5	19.5	20.4	15.6	12.6
5 GHz	54.8	26.3	26.3	27.5	21.3	17.6
10 GHz	80.4	40.1	40.1	41.8	33.0	-
18 GHz	112.4	58.3	58.3	60.6	48.8	-

See HF Low Loss Coax product pages for SB142-26GHz cables with guaranteed attenuation and VSWR performance at frequencies above 18GHz.



# SB (Strip Braid) Coaxial Cable

Harbour's SB coaxial cables have been designed for low attenuation at high frequencies, while using similar dimensions to MIL-DTL-17 constructions. Standard connectors may frequently be used, thereby avoiding tooling charges.

Solid PTFE dielectrics are manufactured with tight tolerances to ensure impedance uniformity and to effect VSWR levels that meet or exceed MIL-DTL-17 specifications for cables of comparable size. The strip braid configuration is by far the most effective means of lowering attenuation levels of coaxial cable at high frequencies while providing shielding effectiveness levels that exceed those of flexible MIL-DTL-17 cables. Flat strips of silver plated copper are braided over the dielectric core, frequently with an intermediate metallized polyester or polyimide layer, and an outer round wire braid. This shielding technique provides superior shielding effectiveness and lower transfer impedance than any standard double braided mil-spec construction.

FEP jackets are typically used, but alternate designs are available such as flame retardant PVC and abrasion resistant overall braids. Marker tapes or surface printing are used for positive identification.

The chart on the following page outlines just a few designs Harbour manufactures. Some of the more popular constructions are standard stock items, and many additional cables are available for prototype assemblies. Many cables not referenced have been designed to meet specific customer requirements.

## Attenuation Calculation and K Factors

Although typical and maximum attenuation values are given for discrete frequencies, typical attenuation values may be calculated by using K1 and K2 factors for each construction. The K1 factor is calculated by taking into consideration the type, strand factor, and diameter of the center conductor, and the impedance of the cable. The K2 factor is calculated by taking into consideration the velocity of propagation and the dissipation factor of the dielectric.

### Formula for Calculating Attenuation using K Factors:

$$\text{Attenuation (dB/100 ft) at any frequency (MHz)} = (\text{K1} \times \sqrt{\text{frequency}}) + (\text{K2} \times \text{frequency})$$

	SB316	SB142/SB142i	SB400	SB304	SB393
K1	.705	.302	.319	.231	.164
K2	.00099	.00099	.00099	.00099	.0012

# SS Rock SStable® Spiral Strip Coax



## Construction:

Center conductor: Solid silver plated copper clad steel

Dielectric: Solid PTFE

Inner shield: Spiral strip of silver plated copper

Outer braid: Round silver plated copper

Jacket: Solid blue FEP

Operating temperature: -55 +200° C

Velocity of Propagation: 70%

Shielding Effectiveness: <-110 dB

	<b>SS402</b>	<b>SS405</b>	<b>SS75086</b>
Center conductor diameter	.037"	.0201"	.0113"
Dielectric diameter	.117"	.064"	.064"
Diameter over inner shield	.125"	.071"	.074"
Diameter over outer braid	.138"	.086"	.082"
Overall diameter	.163"	.104"	.102"
Weight (lbs/mft)	32	14	14
Bend radius	0.8"	0.5"	0.5"
Impedance (Ohms)	50	50	75
Capacitance (pF/ft)	29.4	29.4	19.5
Attenuation (dB/100ft) @	<b>Typ</b>	<b>Typ</b>	<b>Typ</b>
400 MHz	6.4	11.9	12.4
1 GHz	10.5	19.2	19.9
2 GHz	15.5	27.7	28.8
2.4 GHz	17.2	30.6	31.7
3 GHz	19.5	34.5	35.8
5 GHz	26.3	45.7	-
10 GHz	40.1	67.5	-
18 GHz	58.3	95.1	-

See HF Low Loss Coax product pages for SS402-31GHz and SS405-40GHz cables with guaranteed attenuation and VSWR performance at frequencies above 18GHz.

# SS Rock SStable® Spiral Strip Coax

Harbour's SS coaxial cables are flexible alternatives to semi-rigid coax, and the unique shielding configuration offers a cost effective, low attenuation option. The use of strip/round braid composite shields results in low transfer impedance levels. The 50 ohm constructions exhibit the same attenuation characteristics as the M17/130-RG402 and M17/133-RG405 cables. All SS cables have VSWR characteristics that meet or exceed similar size flexible constructions. SS402 and SS405 have been designed with diameters over the outer braids of .141" and .086" respectively, so standard SMA connectors may be used.

An overall FEP jacket is resistant to oil and chemicals. The cable is either unmarked or surface printed eliminating a marker tape that may cause problems in termination. Without the marker tape, an improved level of adhesion exists between the braided core and the jacket that allows ease of termination with short length assemblies.

## Attenuation Calculation and K Factors

Although typical and maximum attenuation values are given for discrete frequencies, typical attenuation values may be calculated by using K1 and K2 factors for each construction. The K1 factor is calculated by taking into consideration the type, strand factor, and diameter of the center conductor, and the impedance of the cable. The K2 factor is calculated by taking into consideration the velocity of propagation and the dissipation factor of the dielectric.

## Formula for Calculating Attenuation using K Factors:

$$\text{Attenuation (dB/100 ft) at any frequency (MHz)} = (\text{K1} \times \sqrt{\text{frequency}}) + (\text{K2} \times \text{frequency})$$

	SS402	SS405	SS75086
K1	.302	.576	.599
K2	.00099	.00099	.00099

# HF HIGH FREQUENCY COAX

LL, SB, and SS cables with guaranteed attenuation and VSWR performance up to 40 GHz

## LL Low Loss - 26 GHz and 40 GHz

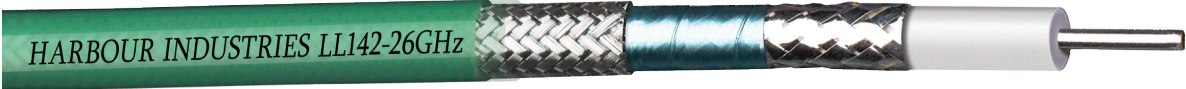

Center Conductor: Solid silver plated copper  
Dielectric: Expanded PTFE tape  
Inner Braid: Flat silver plated copper strip  
Interlayer: Aluminum polyester tape  
Outer Braid: Round silver plated copper  
Jacket: Translucent FEP

Operating temperature -55 +200° C  
Velocity of Propagation 80%-83%  
Impedance 50 Ohms  
Capacitance 25.0 pF/ft  
Shielding Effectiveness <-95 dB

## SB Strip Braid - 26 GHz



Center Conductor: Silver copper clad steel  
Dielectric: Solid PTFE  
Inner braid: Flat silver plated copper strip  
Interlayer: Aluminum polyester tape  
Outer braid: Round silver plated copper  
Jacket: Clear FEP

Operating temperature: -55 +200° C  
Velocity of Propagation: 70%  
Impedance: 50 Ohms  
Capacitance: 29.4 pF/ft  
Shielding Effectiveness: <-95 dB

## SS Rock SStable® - 31 GHz and 40 GHz



Center conductor: Solid silver plated copper clad steel  
Dielectric: Solid PTFE  
Inner shield: Spiral strip of silver plated copper  
Outer braid: Round silver plated copper  
Jacket: Solid blue FEP

Operating temperature: -55 +200° C  
Velocity of Propagation: 70%  
Impedance: 50 Ohms  
Capacitance: 29.4 pF/ft  
Shielding Effectiveness: <-110 dB

# HF HIGH FREQUENCY COAX

LL, SB, and SS cables with guaranteed attenuation and VSWR performance up to 40 GHz

	LL142-26GHz	LL160-40GHz	SB142-26GHz	SS402-31GHz	SS405-40GHz
Center conductor diameter	.051"	.0403"	.037"	.037"	.0201"
Dielectric diameter	.145"	.110"	.117"	.117"	.064"
Diameter over inner braid	.152"	.116"	.127"	.125"	.071"
Diameter over interlayer	.158"	.122"	.133"	---	---
Diameter over outer braid	.178"	.140"	.153"	.138"	.084"
Overall diameter	.195"	.160"	.175"	.163"	.104"
Weight(lbs/mft)	44	28	34.5	32	14
Bend radius	1.0"	0.8"	0.9"	0.8"	0.5"
Attenuation (dB/100ft) @	<b>Typ</b>	<b>Typ</b>	<b>Typ</b>	<b>Typ</b>	<b>Typ</b>
400 MHz	4.7	6.3	6.8	6.4	11.9
1 GHz	7.5	10.0	11.1	10.5	19.2
2 GHz	10.7	14.3	16.3	15.5	27.7
2.4 GHz	11.7	15.7	18.0	17.2	30.6
3 GHz	13.2	17.7	20.4	19.5	34.5
5 GHz	17.2	23.1	27.3	26.3	45.7
10 GHz	24.9	33.4	41.1	40.1	67.5
18 GHz	34.2	46.0	59.1	58.3	95.1
26 GHz	41.9	56.3	74.8	74.4	118.6
31 GHz	---	62.2	---	83.9	132.1
40 GHz	---	71.8	---	---	154.8
<b>Guaranteed VSWR Performance</b>	<b>26 GHz</b>	<b>40 Ghz</b>	<b>26 GHz</b>	<b>31 GHz</b>	<b>40 GHz</b>

# HF HIGH FREQUENCY COAX

LL, SB, and SS cables with guaranteed attenuation and VSWR performance up to 40 GHz

Precision connectors designed specifically to mate with Harbour's HF High Frequency

	LL142-26GHz	LL160-40GHz	SB142-26GHz	SS402-31GHz	SS405-40GHz
2.4mm Plug					*
2.4mm Jack					*
2.4mm Bulkhead Jack					*
2.92mm Plug	*	*		*	*
2.92mm Jack				*	*
2.92mm Bulkhead Jack					*
3.5mm Plug				*	*
3.5mm Jack				*	
3.5mm Bulkhead Jack				*	
SMA Plug	*	*	*	*	*
SMA Jack	*				*
SMA Bulkhead Jack	*	*			
SMA Right Angle Plug	*	*		*	
SSMA Plug				*	*
SSMA Bulkhead Jack					*
TNCA Plug	*	*			
TNCA Bulkhead Jack	*	*			
TNCA Right Angle Plug	*	*			
N Plug	*	*	*	*	
N Bulkhead Jack	*	*			
N R/A Plug	*	*			





# SFL Rock SStable® Spiral Flex Coax



## Construction:

Center conductor: Stranded silver plated copper

Dielectric: Solid PTFE

Inner braid: Spiral silver plated copper strip

Outer braid: Round silver plated copper

Jacket: Solid light blue specially formulated compound

Velocity of Propagation: 70%

Shielding Effectiveness: <-110 dB

	SFL402-105FLEX	SFL405-105FLEX
Center conductor	SPC	SPC
Center conductor diameter	.0376" (7/28)	.0210" (7/33)
Dielectric diameter	.117"	.063"
Diameter over inner braid	.124"	.071"
Diameter over outer braid	.138"	.085"
Overall diameter	.180"	.115"
Weight (lbs/mft)	29	14
Bend radius	0.9"	0.6"
Impedance (Ohms)	50	50
Capacitance (pF/ft)	29.4	29.4
Operating Temperature	-55°C +105°C	-55°C +105°C
Attenuation (dB/100ft)@	<b>Typ</b>	<b>Typ</b>
400 MHz	7.0	13.2
1 GHz	11.4	21.2
3 GHz	20.9	37.8
5 GHz	28.0	49.7
10 GHz	42.2	72.8
18 GHz	60.8	101.5

# SFL Rock SStable® Spiral Flex Coax

Harbour's SFL Spiral Flex™ coaxial cables, more flexible and supple versions of the industry standard SS Spiral Strip constructions, have been designed with a specially formulated 105°C jacket compound and stranded silver plated copper center conductors. These 50 ohm versions exhibit VSWR levels that meet or exceed similar size flexible constructions, and just like their SS cable counterparts, offer excellent shielding effectiveness with readily available connectors.

Although the insertion loss is slightly higher than their SS cable counterparts, SFL attenuation levels through 18 GHz are substantially lower than comparable MIL-DTL-17 constructions.

## Attenuation Calculation and K Factors

Although typical and maximum attenuation values are given for discrete frequencies, typical attenuation values may be calculated by using K1 and K2 factors for each construction. The K1 factor is calculated by taking into consideration the type, strand factor, and diameter of the center conductor, and the impedance of the cable. The K2 factor is calculated by taking into consideration the velocity of propagation and the dissipation factor of the dielectric.

## Formula for Calculating Attenuation using K Factors:

$$\text{Attenuation (dB/100 ft) at any frequency (MHz)} = (\text{K1} \times \sqrt{\text{frequency}}) + (\text{K2} \times \text{frequency})$$

	SFL402-105Flex	SFL405-105Flex
K1	.331	.644
K2	.00091	.00084

# SBF Rock SStable® Strip Braid Flex Coax



**Construction:**

- Center conductor: Stranded silver plated copper
- Dielectric: Solid PTFE
- Inner braid: Flat silver plated copper strip
- Outer braid: Round silver plated copper
- Jacket: Solid light blue specially formulated compound
- Velocity of Propagation: 70%
- Shielding Effectiveness: <-90 dB

	SBF402-105Flex	SBF405-105Flex
Center conductor	SPC	SPC
Center conductor diameter	.0376" (7/28)	.0210" (7/33)
Dielectric diameter	.117"	.063"
Diameter over inner braid	.124"	.071"
Diameter over outer braid	.138"	.085"
Overall diameter	.180"	.115"
Weight (lbs/mft)	29	14
Bend radius	0.9"	0.6"
Impedance (Ohms)	50	50
Capacitance (pF/ft)	29.4	29.4
Operating Temperature	-55°C +105°C	-55°C +105°C
Attenuation (dB/100ft)@	<b>Typ</b>	<b>Typ</b>
400 MHz	8.0	14.0
1 GHz	12.9	22.5
3 GHz	23.6	40.3
5 GHz	31.6	53.1
10 GHz	47.6	78.0
18 GHz	68.4	109.2

# SBF Rock SStable® Strip Braid Flex Coax

Harbour's SBF Strip Braid Flex™ coaxial cables, more flexible and supple versions of the industry standard SS Spiral Strip constructions, have been designed with a specially formulated 105°C jacket compound and stranded silver plated copper center conductors. These 50 ohm versions exhibit VSWR levels that meet or exceed similar size flexible constructions, and just like their SS cable counterparts, offer excellent shielding effectiveness with readily available connectors.

Although the insertion loss is slightly higher than their SS cable counterparts, SBF attenuation levels through 18 GHz are substantially lower than comparable MIL-DTL-17 constructions.

## Attenuation Calculation and K Factors

Although typical and maximum attenuation values are given for discrete frequencies, typical attenuation values may be calculated by using K1 and K2 factors for each construction. The K1 factor is calculated by taking into consideration the type, strand factor, and diameter of the center conductor, and the impedance of the cable. The K2 factor is calculated by taking into consideration the velocity of propagation and the dissipation factor of the dielectric.

## Formula for Calculating Attenuation using K Factors:

$$\text{Attenuation (dB/100 ft) at any frequency (MHz)} = (\text{K1} \times \sqrt{\text{frequency}}) + (\text{K2} \times \text{frequency})$$

	SBF402-105Flex	SBF405-105Flex
K1	.378	.681
K2	.00098	.00099

# MIL-DTL-17 Coaxial Cables

- including M17/176-00002 Twinaxial Data Bus Cable

Harbour Industries is a QPL approved manufacturer of high temperature, high performance coaxial cables supplied in exact accordance with the MIL-DTL-17 specification. The information referenced has been taken from the MIL-DTL-17 “slant sheets” which define complete physical and electrical characteristics for each MIL-DTL-17 part number including dimensional parameters, dielectric materials, shield constructions, VSWR, and maximum attenuation over various frequency ranges. For complete individual slant sheets, see the Defense Supply Center Columbus (DSCC) link in the Industry Links section of Harbour’s website.

## The Importance of VSWR Sweep Testing

When selecting a 50 ohm coaxial cable, constructions with VSWR requirements are highly recommended. Manufacturing and sweep testing cables with concern for VSWR ensures a quality cable free of spikes over the frequency range referenced on the slant sheet.

## Precision PTFE Dielectrics Used

All of the PTFE dielectric coax cables listed are high temperature, high performance constructions exhibiting high dielectric strength and low capacitance in proportion to the cable’s dielectric constant. Harbour manufactures all PTFE dielectric cable constructions with tolerances tighter than the MIL-DTL-17 specification to ensure uniformity of electrical characteristics, especially impedance, attenuation, and VSWR.

## Constructions with PTFE Tape Wrapped Jackets

Harbour manufactures PTFE tape wrapped cables - specifically RG187 A/U, RG188 A/U, RG195 A/U, and RG196 A/U - in accordance with a previous revision of the MIL-DTL-17 specification. These constructions can withstand operating temperatures up to 250 ° versus 200° C for FEP jacketed cables. PTFE tape wrapped cables are generally more flexible than their FEP jacketed counterpart. Alternative 250° constructions are also available with PFA jackets.

M17 Part	Center Conductor	Dielectric Diameter	Shield	Shield Diameter	Jacket	Overall Diameter	Bend Radius	Weight (lbs/mft)	Comments
M17/60-RG142	.037” SCCS	.116”	SPC (2)	.160”	FEP	.195”	1.0”	43.0	
M17/93-RG178	.0120” (7/.004”)SCCS	.033”	SPC	.051”	FEP	.071”	0.4”	6.3	
M17/94-RG179	.0120” (7/.004”)SCCS	.063”	SPC	.080”	FEP	.100”	0.4”	10.8	
M17/95-RG180	.0120” (7/.004”)SCCS	.102”	SPC	.118”	FEP	.141”	0.7”	19.8	
M17/111-RG303	.037” SCCS	.116”	SPC	.136”	FEP	.170”	0.9”	31.0	
M17/112-RG304	.059” SCCS	.185”	SPC (2)	.240”	FEP	.280”	1.4”	94.0	
M17/113-RG316	.0201” (7/.0067”)SCCS	.060”	SPC	.075”	FEP	.098”	0.5”	12.2	
M17/127-RG393	.094” (7/.0312”) SPC	.285”	SPC (2)	.314”	FEP	.390”	2.0”	165.0	
M17/128-RG400	.0384” (19/.008”) SPC	.116”	SPC (2)	.156”	FEP	.195”	1.0”	50.0	
M17/131-RG403	.0120” (7/.004”)SCCS	.033”	SPC (2)	.090”	FEP (2)	.116”	0.6”	15.0	Triaxial RG-178
M17/152-00001	.0201” (7/.0067”)SCCS	.060”	SPC (2)	.091”	FEP	.114”	0.6”	18.5	Double Shield RG-316
M17/176-00002	.0235” (19/.005”)SPA(2)	.042”	SPA	.100”	PFA	.129”	0.6”	18.0	Twinax
RG187 A/U	.0120” (7/.004”)SCCS	.063”	SPC	.079”	PTFE	.100”	0.5”	10.0	Tape Wrapped Jacket
RG188 A/U	.0201” (7/.0067”)SCCS	.060”	SPC	.080”	PTFE	.100”	0.5”	11.0	Tape Wrapped Jacket
RG195 A/U	.0129” (7/.004”)SCCS	.102”	SPC	.117”	PTFE	.141”	0.7”	18.0	Tape Wrapped Jacket
RG196 A/U	.0120” (7/.004”)SCCS	.034”	SPC	.050”	PTFE	.067”	0.4”	6.0	Tape Wrapped Jacket

# MIL-DTL-17 Coaxial Cables

- including M17/176-00002 Twinaxial Data Bus Cable



M17 Part	Impedance (ohms)	Capacitance (pF/ft)	Max Voltage	Attenuation (dB/100 ft)							Max Frequency (GHz)
				100 MHz Typ/Max	400 MHz Typ/Max	1 GHz Typ/Max	2.4 GHz Typ/Max	5 GHz Typ/Max	10 GHz Typ/Max		
M17/60-RG142	50 +/-2	29.4	1900	3.8 / 4.4	8.1 / 9.3	13.7 / 15.3	23.3 / 25.0	37.4 / 41.8	60.0 / 70.7	12.4	
M17/93-RG178	50 +/-2	29.4	1000	14.7 / 16.0	30.2 / 33.0	48.9 / 52.0	78.7 / 83.3				
M17/94-RG179	75 +/-3	19.4	1200		15.8 / 21.0						
M17/95-RG180	95 +/-5	17.4	1500	5.7 / 6.6	11.7 / 17.4	19.2 / 23.0					
M17/111-RG303	50 +/-2	29.4	1900	4.0 / 4.4	8.1 / 9.3	13.4 / 15.3					
M17/112-RG304	50 +/-2	29.4	3000	2.4 / 2.7	5.8 / 6.4	10.0 / 11.1	17.6 / 19.6	25.4 / 28.2		8.0	
M17/113-RG316	50 +/-2	29.4	1200	7.8 / 11.0	16.0 / 21.0	26.3 / 38.0	43.0 / 55.4			3.0	
M17/127-RG393	50 +/-2	29.4	1500	2.2 / 2.5	4.6 / 5.0	7.9 / 9.2	13.5 / 14.2	21.9 / 26.8	35.5 / 37.9	11.0	
M17/128-RG400	50 +/-2	29.4	1900	4.1 / 4.5	8.6 / 10.5	14.2 / 18.1	23.6 / 30.2	37.0 / 52.1	57.8 / 78.0	12.4	
M17/131-RG403	50 +/-2	29.4	1000		33.3 / 37.0						
M17/152-00001	50 +/-2	29.4	1200	7.6 / 11.0	16.0 / 21.0	26.2 / 38.0	41.2 / 55.4	61.3 / 110.0	90.0 / 170.0	12.4	
M17/176-00002	77 +/-7	19.0	1000								
RG187 A/U	75 +/-3	19.4	1200		15.5 / 21.0						
RG188 A/U	50 +/-2	29.4	1200	7.6 / 11.0	16.0 / 21.0	26.2 / 38.0	41.2 / 55.4			3.0	
RG195 A/U	95 +/-5	17.4	1500		11.7 / 17.4						
RG196 A/U	50 +/-2	29.4	1000	13.0 / 16.0	27.2 / 33.0	41.7 / 52.0	64.0 / 80.0			3.0	

° UL approvals for many of the MIL-DTL-17 cables listed are available upon request.

° Maximum frequencies are those referenced on individual slant sheets of the MIL-DTL-17 specification. No values are given above 400MHz for unswept constructions because MIL-DTL-17 specification recommends these cables should not be used above this frequency.

° The MIL-DTL-17 specification references maximum attenuation values as shown in the above chart, however typical values are substantially lower. For the more popular constructions, the following K factors may be used to calculate typical attenuation at any specific frequency.

	M17/60-RG142	M17/93-RG178	M17/94-RG179	M17/113-RG316	M17/128-RG400	M17/127-RG393
K1	.355	1.420	.766	.750	.390	.200
K2	0.00245	0.0034	0.00119	0.0026	0.00188	0.00155



# HS (High Strength) Coaxial Cable



## Construction:

Center Conductor: stranded, silver plated copper clad steel (alloys optional)

Dielectric: solid PTFE

Braid: silver plated copper clad steel (alloys optional)

Jacket: FEP

Part Number	Center conductor diameter	Dielectric diameter	Diameter over inner braid	Overall diameter	Impedance (ohms)	Capacitance (pF/ft)
HS 178	.0120" (7/.0040")	.033"	.049"	.071"	50	32
HS 179	.0120" (7/.0040")	.063"	.080"	.100"	75	23
HS 180	.0120" (7/.0040")	.102"	.118"	.141"	95	17
HS 316	.0201" (7/.0067")	.060"	.076"	.098"	50	32

# TRX (Triaxial) Cable



## Construction:

Center Conductor: silver plated copper or copper clad steel

Dielectric: solid PTFE

Inner braid: silver plated copper

Interlayer: FEP

Outer Braid: silver plated copper

Jacket: FEP

Part Number	Center conductor diameter	Dielectric diameter	Diameter over inner braid	Diameter over interlayer	Diameter over outer braid	Overall diameter	Impedance (ohms)
M17/131-RG403	.0120" (7/.0040")	.033"	.049"	.074"	.090"	.116"	50
TRX316	.0201" (7/.0067")	.060"	.076"	.096"	.112"	.140"	50
TRX142	.037" Solid	.116"	.136"	.166"	.186"	.215"	50
TRX400	.0384" (19/.008")	.116"	.136"	.166"	.186"	.215"	50
TRX179	.0120" (7/.0040")	.063"	.079"	.099"	.115"	.141"	75
TRX180	.0120" (7/.0040")	.102"	.118"	.138"	.154"	.180"	95

# Phase Stability over Temperature

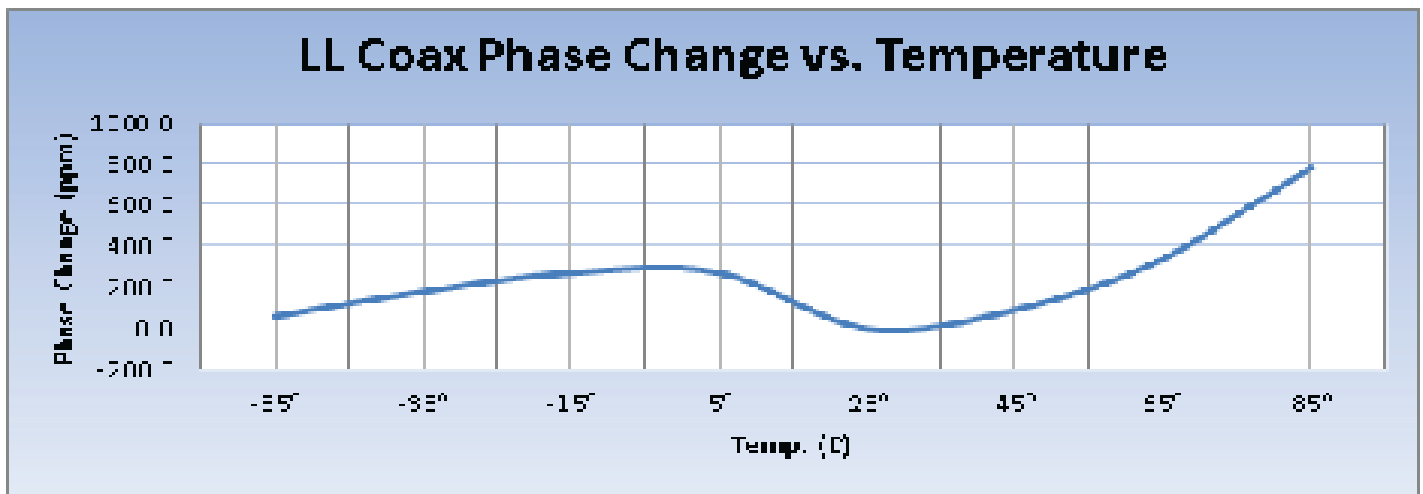

Harbour created the above graph by measuring the time delay change of a 10ft length of LL Low Loss coax when subjected to the following conditions:

- Place the assembly in a cold box and oven chamber and connect to a Network Analyzer
- Soak the assembly for 2hrs at 20°C and record the initial measurement. This is the reference value Td (ref)
- Decrease the temperature to -55°C and soak for 1 hour before recording measurement. Td (@ temp)
- Raise the temperature at 20°C intervals; soak the assembly for 1 hour before recording data. Td (@ temp)
- Calculate ppm with 2 equations: 1st calculate the difference from the reference:  $\Delta Td = Td(ref) - Td(at\ temp)$   
2nd calculate ppm using the formula:  $ppm = \Delta Td(ref) \times 10^6 / Td(ref)$

Phase change occurs as a result of environmental changes: mechanical stresses, connector torque, and thermal conditions. Phase change is expressed in change of the electrical length (EL). Using the above information, phase change can be predicted by using the formula:

$$\Delta EL = EL \times (ppm/10^6)$$

Before calculating the expected phase shift, a few additional questions need to be answered:

- What is the mechanical length of the assembly (ft.)?
- What is the frequency of interest (GHz)?
- What is the dielectric constant of the insulation (E)?
- What is the temperature of interest (°C)?
- What is the electrical length at the frequency of interest (EL)?

$$EL = 365.7 \times \sqrt{E} \times (ft) \times (GHz)$$

For example, the phase change of a 10 ft. LL142 assembly at -35°C and at 18GHz is 15.32°

Step 1. Electrical length (EL)

$$EL = 365.7 \times \sqrt{1.5} \times 10 \times 18 = 80,620^\circ$$

Step 2. Using the chart above identify the ppm at -35°C

$$ppm = 190$$

Step 3. Solve for the change in Phase ( $\Delta EL$ )

$$\Delta EL = 80,620^\circ \times (190/10^6) = 15.32^\circ$$



## Power Handling Capability of Coaxial Cable

To select an appropriate coaxial cable for the transmission of power it must be confirmed that the cable is capable of withstanding a certain voltage without arcing and dissipating the generated heat without exceeding acceptable temperature limits.

**Peak power handling** is dependent on the dielectric strength of the insulating materials and dimensions of the coax. Failure of the coax to withstand the necessary voltage will result in arcing between the inner and outer conductors. For non-air dielectrics the exact peak power handling limit for a coax is largely irrelevant as arcing will occur at the interface of the cable and connector at much lower voltage than through the dielectric of the cable.

**Average power handling** is dependent on (a) the amount of heat generated within the cable due to losses, (b) the ability of the cable to dissipate that heat radially to the surface of the cable, and (c) the rate at which the surface of the cable can transfer the heat to the surrounding environment. Heat is generated within the cable due to attenuation of the signal and is proportional to the input power and the frequency of the signal.

The heat is transmitted from the core to the surface of the cable dependent on the dimensions and thermal conductivities of the various layers making up the coax and the temperature gradient within the cable. At the surface the heat is transferred to the surrounding air based on the cable surface area, the surface and ambient temperatures, the emissivity of the surface and the flow of air. The maximum average power for a coax is determined such that at no location within the cable does the steady state temperature exceed the temperature rating of the material.

For RF applications, average power handling is most commonly used. The following graphs provide recommended average power handling limits for a variety of Harbour Industries' coaxial constructions. This information is for reference only and the suitability of any cable for a particular application should be confirmed taking into consideration the exact usage and environmental conditions.

Power Handling vs. Frequency data for MIL-DTL-17 Coax Cables may be found on individual "slant sheets" at the Defense Supply Center Columbus (DSCC) website: [www.landandmaritime.dla.mil](http://www.landandmaritime.dla.mil)

# Maximum Power Handling Capability of Coaxial Cable (In Watts)

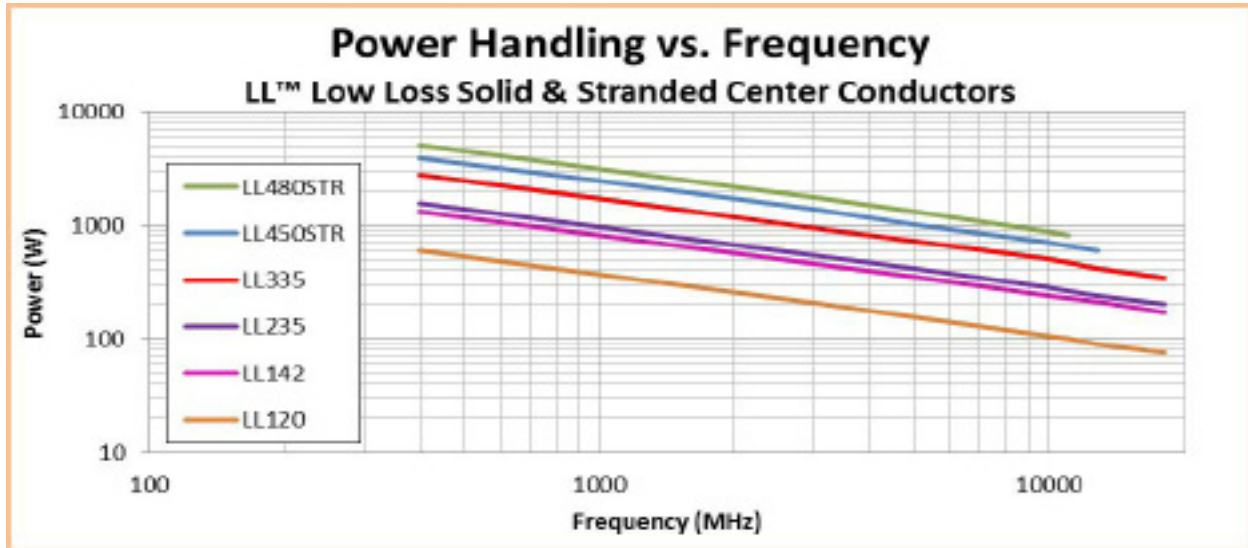

	400MHz	1GHz	3GHz	5GHz	10GHz	18GHz
LL120	590	370	205	155	105	76
LL142	1310	820	460	350	240	170
LL235	1550	970	545	415	280	200
LL335	2750	1700	950	730	500	345
LL450STR	3900	2450	1370	1020	700	-
LL480STR	5100	3160	1750	1310	870	-

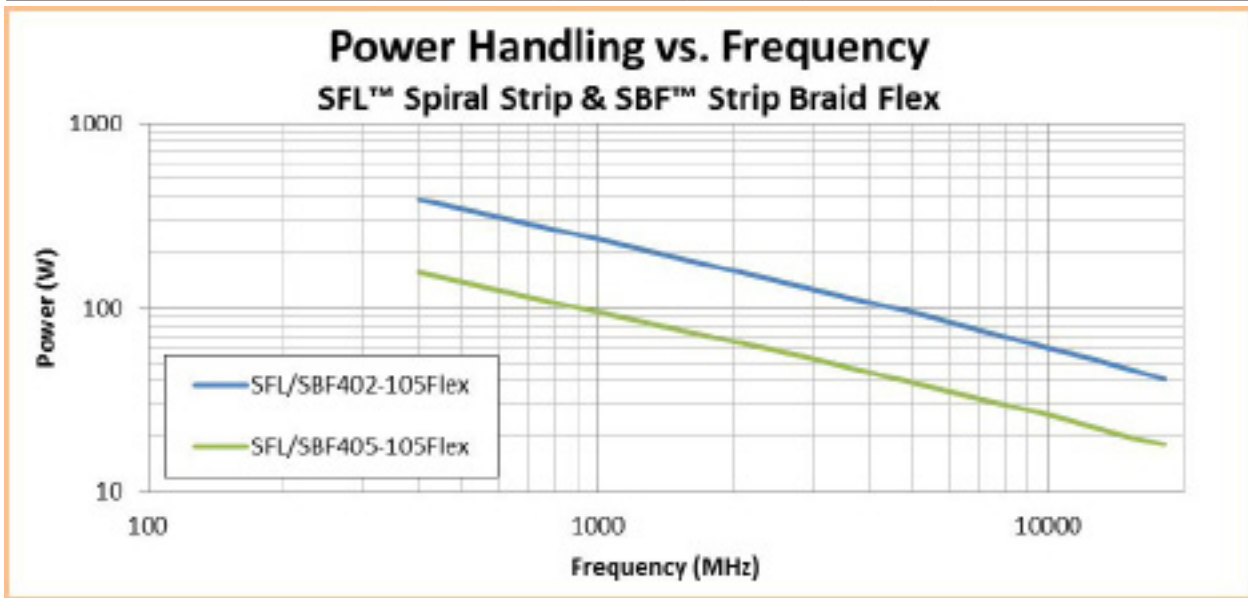

	400MHz	1GHz	3GHz	5GHz	10GHz	18GHz
SFL/SBF405-105Flex	155	95	53	39	26	18
SFL/SBF402-105Flex	385	235	125	95	60	41

(Recommend limits are for reference only and calculated assuming 25°C ambient at sea level in free air)

# Maximum Power Handling Capability of Coaxial Cable (In Watts)

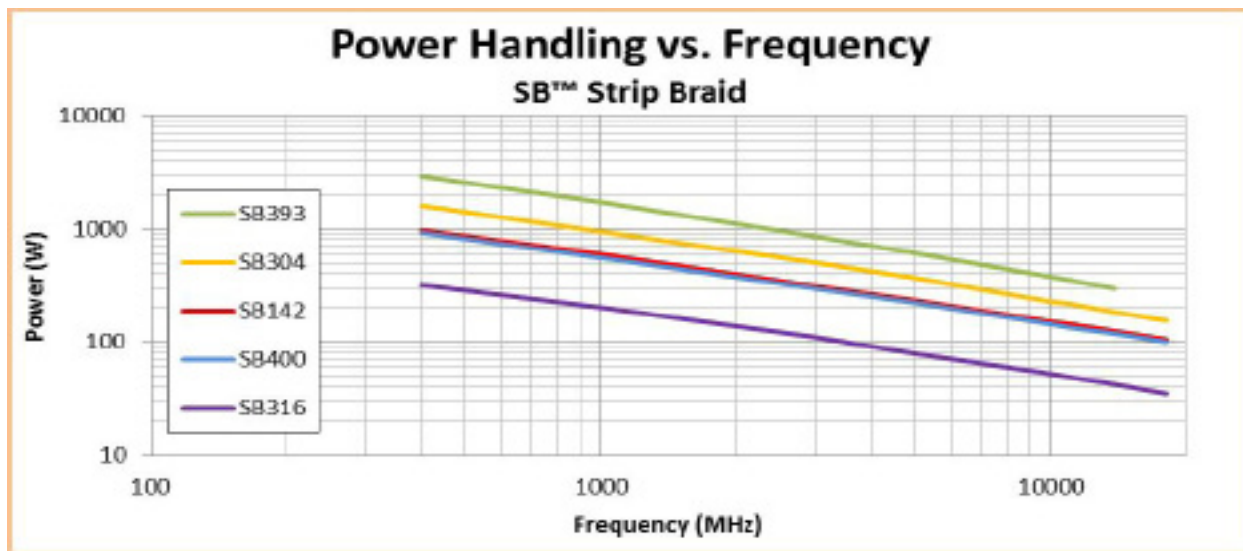

	400MHz	1GHz	3GHz	5GHz	10GHz	18GHz
SB316	320	200	110	80	52	35
SB400	920	560	300	220	145	100
SB142	965	590	315	235	150	105
SB304	1585	950	500	365	230	155
SB393	2890	1700	860	615	375	-

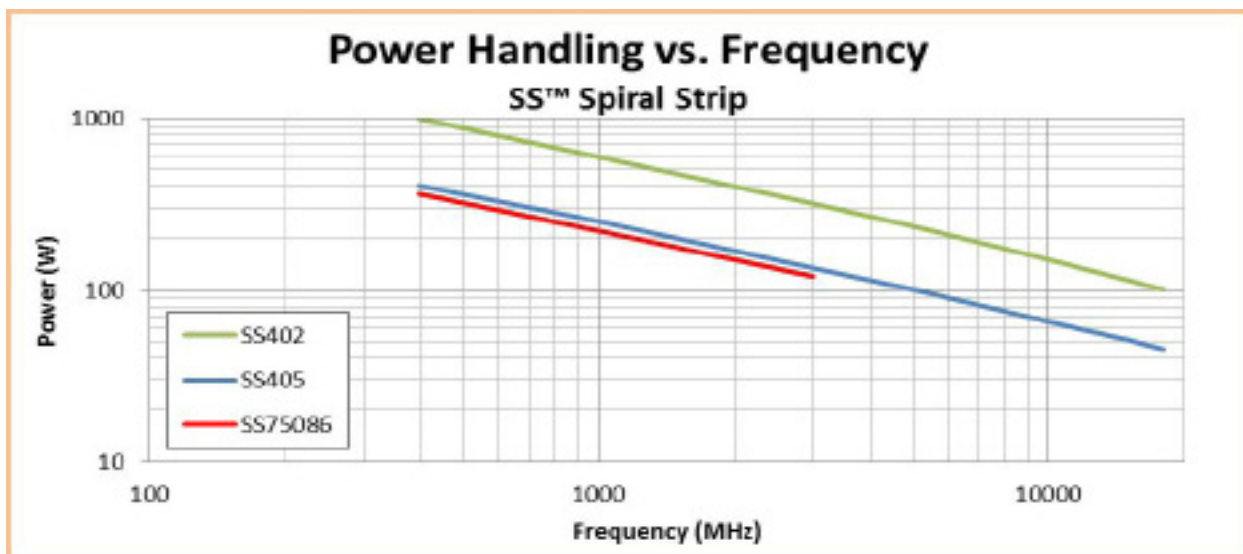

	400MHz	1GHz	3GHz	5GHz	10GHz	18GHz
SS75086	360	220	120	-	-	-
SS405	405	250	135	100	65	45
SS402	990	600	320	235	150	100

(Recommend limits are for reference only and calculated assuming 25°C ambient at sea level in free air)

# Phase Stability over Flexure

Phase stability over flexure can be significantly affected by the cable assembly technique, cable bend radius, and the length of the cable assembly. Harbour's Low Loss coax cables are typically tested for phase stability over flexure using an Agilent E8362B Network Analyzer using the following procedure:

- a. Perform dynamic testing on a given length of cable (see Figure 1)
- b. Record phase in the network analyzer
- c. Flex cable over various size mandrels depending on the cable diameter
- d. Retest cable for phase change when the cable is coiled around the mandrel
- e. Record change in the network analyzer
- f. Display phase change on the analyzer as degrees of change over frequency.

Performance - less than:

+/- 2.0° up to 4 GHz

+/- 4° from 4.01 to 8 GHz

+/- 6° from 8.01 to 18 GHz

Phase Change (degrees)

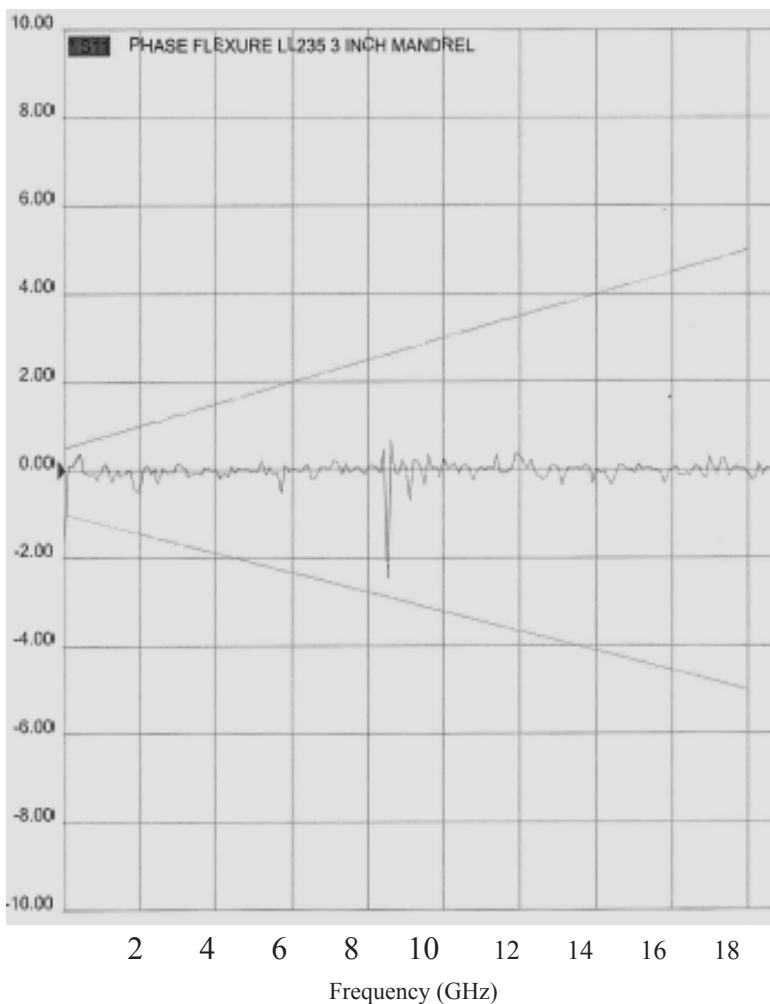

Dynamic Bend Test (Figure 1)

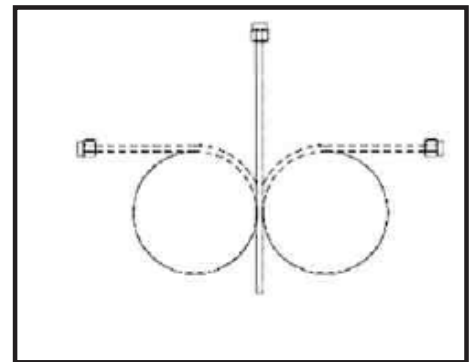

This data is representative of anticipated results. As phase stability over flexure is application dependent, please contact the factory regarding your specific cable and application.





## VSWR and Return Loss of Coaxial Cables

Voltage Standing Wave Ratio (VSWR) and Structural Return Loss (SRL) are basically the same - only different. Both terms are used to characterize the uniformity of a cable's impedance along its length as it relates to reflected energy. VSWR is essentially the ratio of the input impedance to the average characteristic impedance as a result of signal losses due to reflections and is expressed as a ratio (1.xx:1). SRL is the measurement of reflected energy expressed in decibels (dB). Connectors and termination techniques are major sources of reflected energy and can significantly deteriorate system VSWR or SRL. The difference between VSWR and SRL is no more than how the reflected energy is measured.

Structural Return Loss (SRL) is expressed as VSWR (Voltage Standing Wave Ratio) by the following formula:

$$\text{VSWR} = \frac{1 + 10^{\text{RL}/20}}{1 - 10^{\text{RL}/20}}$$

SRL	VSWR	SRL	VSWR	SRL	VSWR
-40dB	1.0202:1	-30dB	1.0653:1	-20dB	1.2222:1
-39dB	1.0227:1	-29dB	1.0736:1	-19dB	1.2528:1
-38dB	1.0255:1	-28dB	1.0829:1	-18dB	1.2880:1
-37dB	1.0287:1	-27dB	1.0935:1	-17dB	1.3290:1
-36dB	1.0322:1	-26dB	1.1055:1	-16dB	1.3767:1
-35dB	1.0362:1	-25dB	1.1192:1	-15dB	1.4326:1
-34dB	1.0407:1	-24dB	1.1347:1	-14dB	1.4985:1
-33dB	1.0458:1	-23dB	1.1524:1	-13dB	1.5769:1
-32dB	1.0515:1	-22dB	1.1726:1	-12dB	1.6709:1
-31dB	1.0580:1	-21dB	1.1957:1	-11dB	1.7849:1
				-10dB	1.9250:1



## Power vs. Temperature Derating Factors

The chart below recalculates the power handling capability of a coaxial cable at various temperatures.

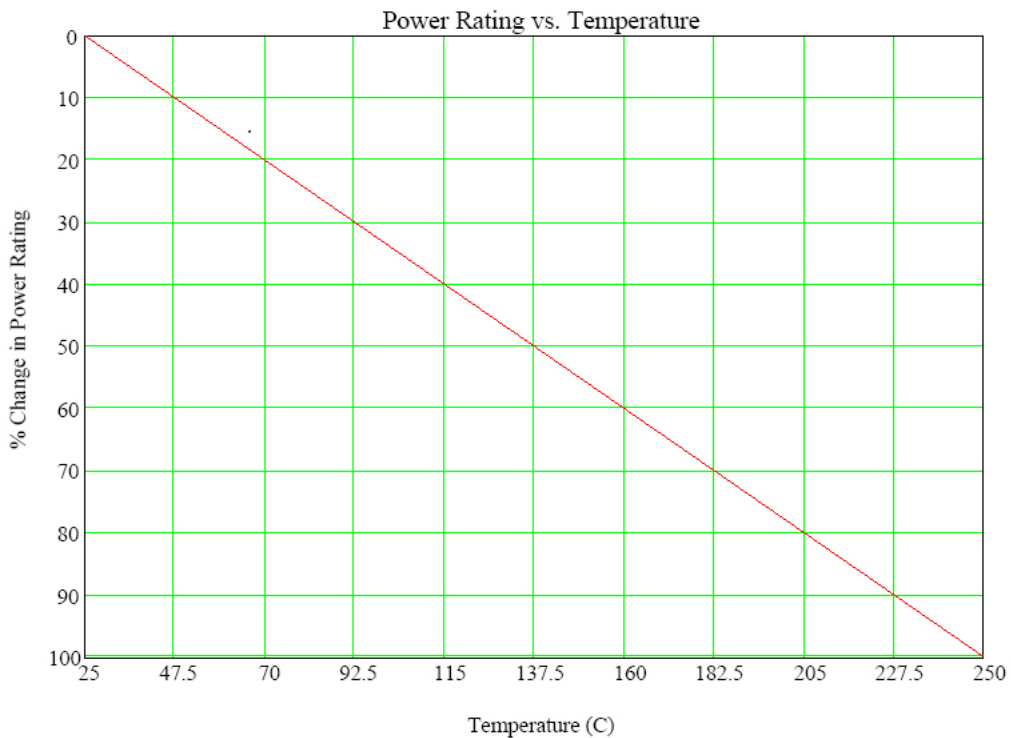



*Harbour*  
INDUSTRIES  
High Performance Wire & Cable

## Attenuation vs. Temperature Correction Factor for Coaxial

The chart below recalculates the attenuation of a coaxial cable at various temperatures.

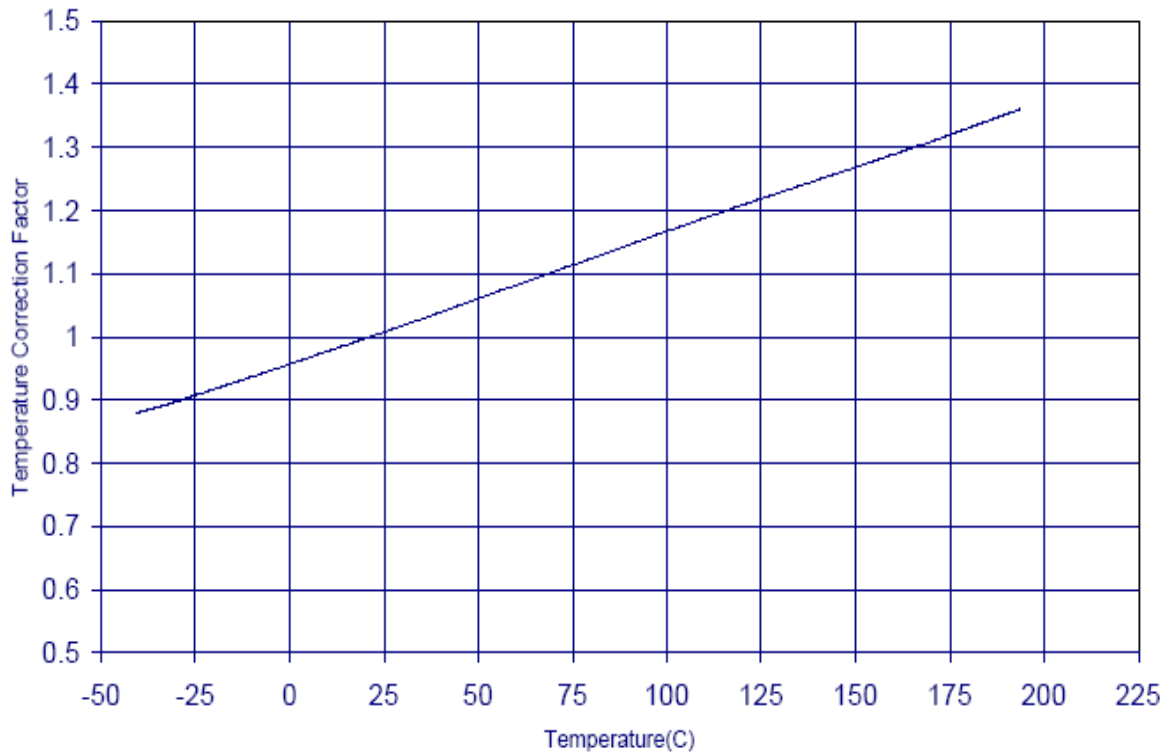

# **Shielding Effectiveness Test Method**

## **Harbour's LL, SB, and SS Coaxial Cables**

### **Designs for Improved Shielding Effectiveness**

Harbour Industries has been manufacturing strip braided expanded PTFE dielectric coaxial cable (LL series) and strip braided solid PTFE dielectric coaxial cable (SB series) since 1988. The strip braid design is a proven, effective shield configuration. Flat strips of silver plated copper are braided over the dielectric, then an intermediate aluminum polyester or aluminum polyimide tape is applied under a silver plated copper round wire braid.

#### ***The need for improved shielding effectiveness***

High frequency cable and assemblies have been traditionally used in applications requiring a high level of shielding such as commercial and military aviation, defense systems, antenna systems and microwave test leads. Today, cellular and personal communication systems (PCS) require cable and assemblies with the same high level of shielding. Cables must provide adequate isolation to preserve the integrity of the system and to avoid interference with over-the-air communications.

Harbour supplies cable assembly houses with reliable high performance cable. Test data must be given, including impedance, attenuation, structural return loss, and shielding effectiveness. Since the strip braid composite configuration had previously been used and published data existed, there seemed to be little need for testing cables for shield effectiveness. Later, however, it was discovered that many cable manufacturers made general statements about shielding, but did not perform shielding effectiveness tests, certainly not at frequencies above 1 GHz. At best, one RF leakage number was given for a given shield configuration. Test procedures were difficult to obtain.

#### ***A new, improved shield configuration***

In 1993, Harbour designed a new SS series of high frequency coaxial cables with a new shield design of silver plated copper strip spiraled around a solid PTFE dielectric. Since these cables were frequently used as flexible alternatives for semi-rigid coax, it was time to develop a reliable, repeatable test procedure for shielding effectiveness. RF leakage and transfer impedance were considered in developing a test method. Other methods, such as open field antenna sites, absorbing clamps, and TEM cells were deemed less reliable in comparing one cable to another.

#### ***Shielding effectiveness (RF leakage and transfer impedance)***

Radiation, or the transformation of energy out of a coaxial cable, is known as RF leakage. The formula for RF leakage is as follows:

$$dB = 10 \log_{10} \frac{P_t}{P_i}$$

RF leakage, measured in decibels (dB), compares the input power level ( $P_i$ ) to the power level propagating in the test chamber ( $P_t$ ). The power in the test chamber is a function of the chamber itself and the attenuation, impedance and velocity of propagation of the cable under test. Importantly, the ability of the shield to attenuate the energy passing through it enables comparison of various shield configurations. The transfer impedance of a coaxial cable is defined as the ratio of the voltage in the disturbed circuit to the current flowing in the interfering circuit. The current on one surface of the shield is related to the voltage drop generated by this current on the opposite surface of the shield. This value depends solely on the shield construction.

### Test setup

Shielding effectiveness testing was performed to evaluate the relative ratings of different cables. Testing was performed in accordance with MIL-T-81490, with actual measured values difficult to substantiate. Repeatability was questionable. Therefore, the following triaxial test assembly was constructed in accordance with MIL-C-39012C for RF leakage.

Figure 1: Triaxial test assembly

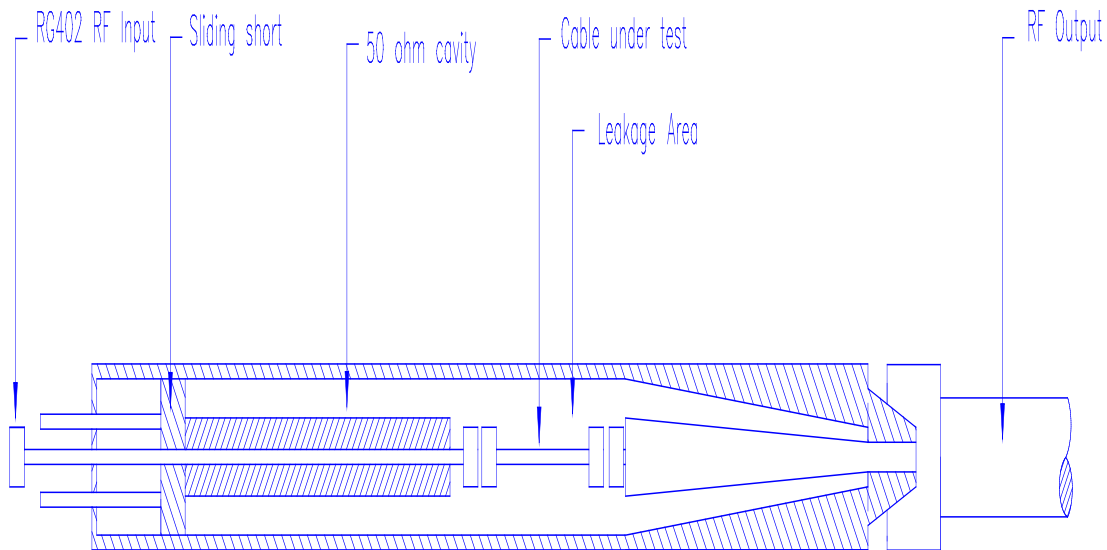

A Hewlett Packard Network Analyzer was calibrated and used with the triaxial test assembly as shown in Figure 2. To differentiate cable leakage from connector leakage, 4 and 8 inch test cables were used. For connector leakage, a test sample of 8 inches versus 4 inches will not increase the measured leakage. For a cable leakage, the longer sample will increase the measured leakage by +6 dB. Therefore, if the longer cable causes a 6 dB change in measured leakage, it can be deduced that the leakage is coming from the cable and not the connector or connector/cable interface.

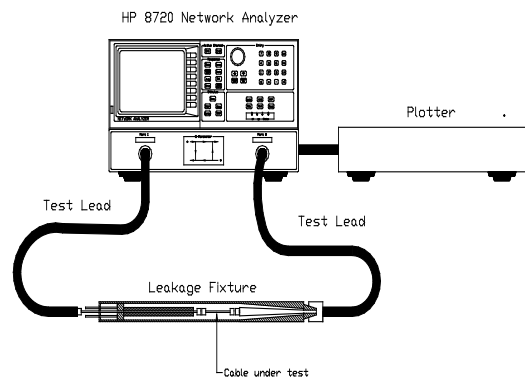

Figure 2: Shielding effectiveness test setup

The following shielding effective test procedure was developed:

1. Connect a semi-rigid calibration cable within the leakage cell into the internal matched termination.
2. Solder all connections for calibration to eliminate any leakage.
3. Connect the input side of the leakage cell to port one of the analyzer and connect the output side of the leakage cell to the analyzer with the other test cable. (The calibration measurement of the system must meet the device under test levels by at least -6 dB. For Harbour's setup, the specification was -90 dB prior to testing, with a calibration reading of - 96 dB minimum required prior to testing.)
4. Measure the insertion loss over the band of the sweep.
5. Once the required value is met for calibration, store the data to memory in the analyzer.
6. Disconnect the calibration samples within the cell.
7. Move the coaxial cable out of the cell, and insert the test sample between the calibration cable connection just separated.
8. Reconnect the test cell and re-measure the insertion loss. Adjust connections to eliminate false leakage signals from inhibiting the measurement. (Use aluminum foil to prevent connector leakage.)
9. Slide the short circuit rod within the leakage cell back and forth to cover at least one half wavelength of travel at the test frequency. This is to phase tune the leakage signals with the output connector, maximizing the signal at any variable phase. The sliding of the variable short circuit is not required when making swept frequency measurements since phase tuning will be accomplished over the band. The sliding short circuit is used for a fixed, single frequency measurement test to ensure there is not a null resonance within the cavity.
10. Once a proper measurement has been reached, and the measured leakage signal resembles that of the test cable, plot the result and store it to a disk file, similar to all other microwave test measurements. (This plot has the stored memory trace of the fixture calibration and the test cable. The intent is to notice the measurement noise level, relative to the leakage from the test cable.)
11. Disconnect the leakage cell, reconnect the calibration test cables within the cell to make sure the noise floor is still within the required levels given above.



Typically, leakage measurements over frequency can have two responses. If there is a physical gap or leak, the leakage response will show more leakage as frequency is increased. If there is a conductive, or absorptive path for leakage, the low frequency leakage may appear higher, since this path is shorter at lower frequencies and attenuating the signal more at higher frequencies. Any leakage due to a cutoff effect similar to an opening in a shield will show more leakage as the frequency is increased.

RF leakage testing was performed from 50 MHz to 18 GHz in order to compare the LL, SB, and SS cables with MIL-DTL-17 constructions. The results for the MIL-DTL-17 cables are consistent with previously reported values. Single and double braided shield configurations (even those with greater than 90% braid coverage) exhibit the highest RF leakage, at -50 and -75 dB respectively. The LL and SB cables with composite strip braid/round wire braid configurations exhibited lower RF leakage of -95 dB. Spiral strip shields (used in the SS cables) further improved the RF leakage to -110 dB. The tightly applied strip used in this shield type most closely approximates the solid copper tube of a semi-rigid cable. As a result, leakage levels down to the noise floor of the test equipment are exhibited.

Sample		Shield Configuration	RF Leakage
Number	Cable type		
1	M17/111-RG303	single round wire silver plated copper braid	- 50 dB
2	M17/60-RG142	double round wire silver plated copper braids	- 75 dB
3	LL142	silver plated copper strip braid, mylar, round wire silver plated copper braid	- 95 dB
4	SB142	silver plated copper strip braid, mylar, round wire silver plated copper braid	- 95 dB
5	SS402	spiral wrapped silver plated copper strip, round wire silver plated copper braid	-110 dB
6	SS405	spiral wrapped silver plated copper strip, round wire silver plated copper braid	-110 dB
7	M17/133-RG405	solid copper tube	-110 dB

### ***Additional Testing for SS Cables***

Additional tests were performed to evaluate the effectiveness of the SS402 and SS405 cables when bent. These tests compared samples 5 and 6 to the following samples:

Sample 8: An 8 inch test cable of SS402 with a 360° loop was bent into a tight .52" radius to fit inside the test cell. This bend radius exceeded the .82" minimum recommended bend radius for the cable (five times the .163" diameter). RF leakage was measured at - 100 dB. When the spiral strip shielded SS402 cable was tightly bent, the inner tape separated just enough to cause a + 10 dB change in shielding effectiveness.

Sample 9: An 8 inch test cable of SS405 with a 360° loop and was bent with a .52" radius, then inserted into the test cell. This bend radius was the minimum recommended bend radius of the cable (five times the .104" diameter). The RF leakage was measured at - 110 dB, the same as the straight length of the cable and the noise floor of the equipment.

Table 2: SS402 and SS405 Test Results

Sample		Bend radius of the sample	Minimum recommended bend radius	RF Leakage
Number	Cable type			
5	SS402, straight	N/A	.82"	- 110 dB
8	SS402, 360 loop	.52"	.82"	- 100 dB
6	SS405, straight	N/A	.52"	- 110 dB
9	SS405, 360 loop	.52"	.52"	- 110 dB

The above tests show that bent lengths of Harbour's SS cables exhibit the same shielding effectiveness level as straight lengths, if the minimum bend radius is not exceeded.

### ***Using the shielding effectiveness test method as a design tool***

Harbour's RF leakage cell allows the convenient testing of many different cables at frequencies up to 18 GHz. It provides an effective, reliable and repeatable method not only for testing, but for the design of effective shield configurations. Physical characteristics of the braid configuration -- braid angles, picks per inch, number of carriers, braid coverage, tape widths, tape thickness, and percent overlap of metal tapes -- can be tested and modified for optimal shielding effectiveness.



*Harbour*  
**INDUSTRIES**  
*High Performance Wire & Cable*

Harbour Industries LLC  
4744 Shelburne Road  
P. O. Box 188  
Shelburne, VT 05482  
Tel: (802) 985-3311 or (800) 659-4733  
Fax (802) 985-9534  
e-mail: [sales@harbourind.com](mailto:sales@harbourind.com)

Harbour Industries LTD  
1365 Industrial Blvd.  
Farnham, Quebec Canada J2N 2X3  
Tel: (450) 293-5304  
Fax: (450) 293-2421

[www.harbourind.com](http://www.harbourind.com)



A Marmon Wire & Cable/Berkshire Hathaway Company