

# KONA<sup>®</sup>

Professional Performance,  
Unparalleled Reliability

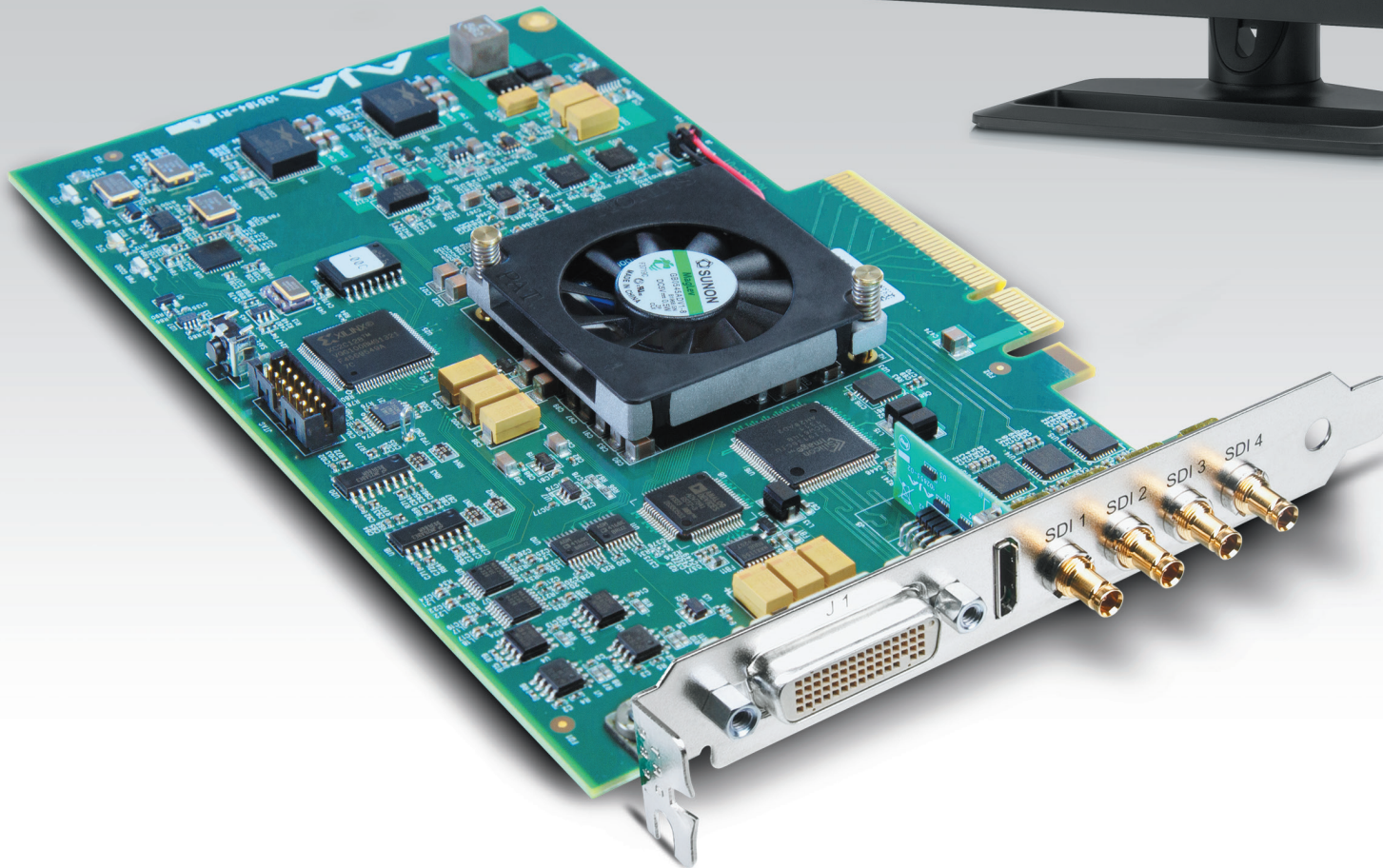

**AJA**<sup>®</sup>  
VIDEO SYSTEMS

Because it matters.<sup>®</sup>

# KONA

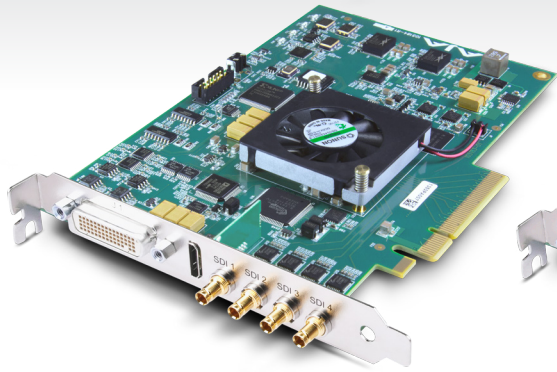

KONA 4

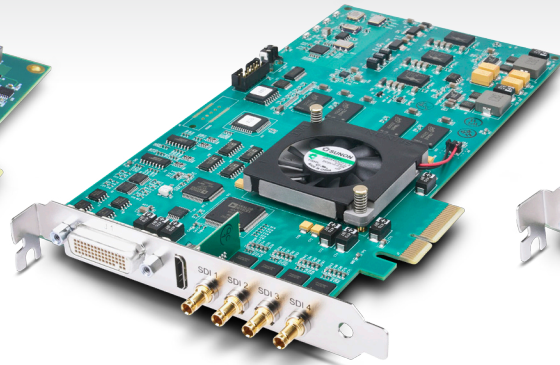

KONA 3G

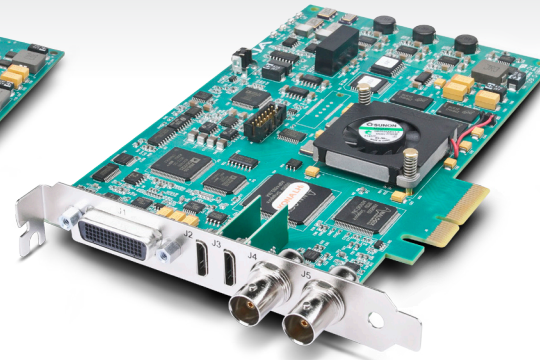

KONA LHi

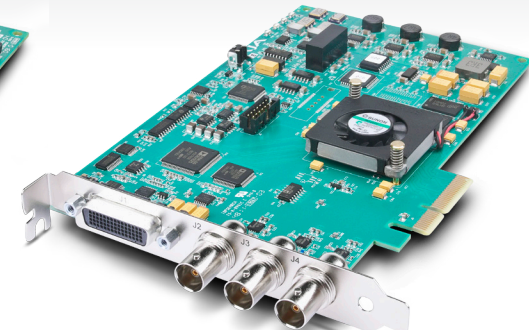

KONA LHe Plus

AJA's KONA family of I/O cards deliver a complete range of performance and connectivity options to fit any budget or workflow from standard definition to 4K.

## Professional Performance, Unparalleled Reliability

**Built for the exacting demands of video professionals, KONA cards offer the highest quality video and audio I/O with a range of features tuned for your workflow.**

Whatever your post production process, KONA capture, display and mastering solutions for SD, HD, 3G, Dual Link HD, 2K and 4K on a Mac, Windows or Linux, provide the best engine for your creative process.

In a world of myriad HD standards, SD, 2K, stereoscopic 3D and growing 4K workflows, KONA cards offer maximum connectivity like 3G/HD/SD SDI, Component, and HDMI, along with the flexibility of AJA's high-quality conversion capability.

No more rendering for raster resizing, KONA's superior 10-bit hardware-based up-, down-, cross-conversion offers you the ability to ingest to the resolution of your project while displaying and mastering live simultaneously to HD and SD as your needs require.

At AJA we understand that creative professionals have a range of software applications and platforms they prefer and need to work with. Using AJA's industry-leading Mac and Windows drivers and custom application plug-ins, KONA cards support the broadest range of creative software. Pick your applications of choice and KONA connects it to your world.

Built to the exacting standards of all AJA hardware, KONA cards are backed by our world-class support network, 3-year international warranty and advanced exchange service.



# KONA



[View Compatibility Chart](#)

## Software Compatibility

**KONA cards are cross-platform and compatible with a wide range of professional Mac and Windows software applications.**

AJA hardware is compatible with a wide range of professional software applications on both Mac and Windows. AJA drivers and plug-ins create a seamless integration between the native software and AJA's high-quality hardware that lets you focus on the work, not the technology.

**View our software compatibility chart for the following categories:**

Color | Editorial | Effects | Streaming/Live Production | Audio | Ingest/Playout | Dailies | Graphics | Test/Measure | Restoration



\* For more information on the latest Software Compatibility please visit: [www.aja.com/en/category/edit/compatibility](https://www.aja.com/en/category/edit/compatibility)

# KONA

## Features Comparison Chart

KONA capture cards are available in three models to meet your workflow needs, all built with AJA's reputation for quality, reliability and support.

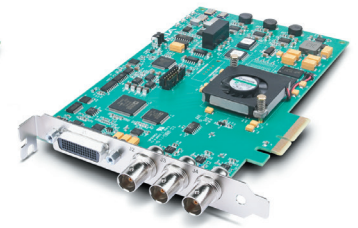
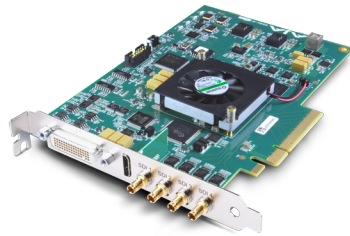

**KONA 4**

**KONA 3G**

**KONA LHi**

**KONA LHe Plus**

SD (NTSC and PAL)	yes	yes	yes	yes
HD (720p, 1080i, 1080sf)	yes	yes	yes	yes
2K (2048 x 1556, 2048 x 1080) Dual Link HD, 2K HSDL, 4:4:4 RGB	yes	yes	2K x 1080 video at 4:2:2, non-RGB	-
4K (3840 x 2160, 4096 x 2160) YCbCr and RGB colorspaces	yes	yes	-	-
4K HFR	yes*	-	-	-
3G SDI	yes	yes	yes	-
HDMI	HDMI 1.4 with Support for 2.0 level B resolutions	HDMI 1.4a output	HDMI 1.3a input/output	-
HD to SD Down-conversion (10-bit, in hardware)	yes	yes	yes	yes
SD to HD Up-conversion (10-bit, in hardware)	yes	yes	yes	-
HD to HD Cross-conversion (1080 to/from 720, 10-bit, in hardware)	yes	yes	yes	-
12-bit Analog Video (component, composite, and Y/C)	output SD/HD	output SD/HD	input/output SD/HD	input/output SD/HD
10-bit SDI Digital Video (BNC)	4x 3G Bi-Directional	input/output SD/HD/3G	input/output SD/HD/3G	input/output SD/HD
HD Video+Key	yes	yes	-	-
Analog Audio (balanced XLR)	-	-	input/output 2-channel	input/output 2-channel
AES Digital Audio	8-ch I/O w/cable, 16-ch I/O w/K3G-Box	8-ch I/O w/cable, 16-ch I/O w/K3G-Box	input/output 2-channel	input/output 2-channel
Embedded SDI Audio (via BNC)	input/output 16-channel	input/output 16-channel	input/output 8-channel	input/output 8-channel
Professional Genlock	yes	yes	yes	yes
LTC Input/Output	yes	yes	LTC input (shared with reference BNC)	-
RS-422 Machine Control	yes	yes	yes	yes
1RU Breakout Box (optional)	yes	yes	yes	yes
3-year AJA Warranty with Advanced Exchange	yes, included	yes, included	yes, included	yes, included

\*With proper hardware and software support applications.



# KONA 4

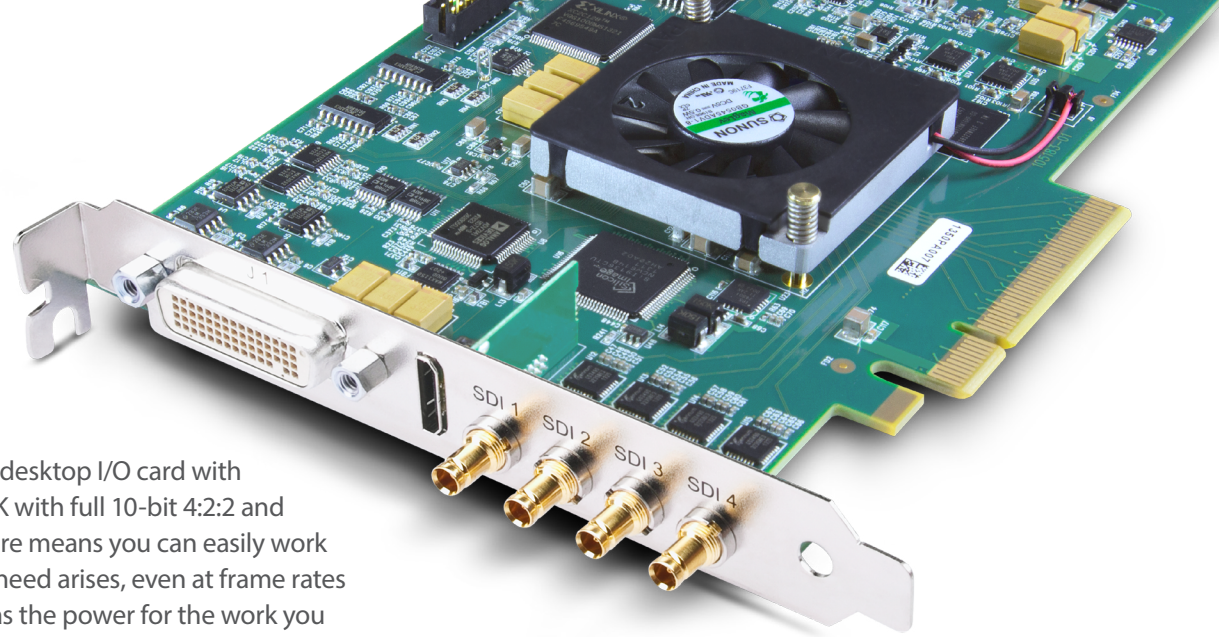

Powerful integration.  
Professional connectivity.

KONA 4 offers users a single, powerful 8-lane PCIe 2.0 video and audio desktop I/O card with unparalleled features for handling everything from SD to HD, 2K and 4K with full 10-bit 4:2:2 and 4:4:4 color spaces for fantastic image clarity. The futureproof architecture means you can easily work with HD and 2K now and switch to working at 4K resolution when the need arises, even at frame rates up to 50/60 fps, without the requirement for new hardware. KONA 4 has the power for the work you do today and into the future.

Only **\$1,995** US MSRP\*

[Find a Reseller](#)



## Powerful

In addition to HFR support at 4K up to 50/60 fps, KONA 4 also supports AJA Raw capture at up to 120 fps via 4 3G-SDI connections. Create beautiful and detailed slow motion with an engaging cinematic feel via AJA Control Room.



## Integration

KONA 4's broadcast quality up, down, cross-converter unifies resolutions, simplifying workflows and eliminating the need to adjust resolution within software. The powerful hardware downstream keyer allows graphics and images to be overlaid on the video being input to the card.



## Professional Connectivity

KONA 4 features bi-directional 3G-SDI connections that can be used for input and output. HDMI 1.4a monitoring output, LTC I/O, Genlock input, RS-422 control, configurable 3 x BNC SD/HD analog video output and 8-channel AES audio I/O allow KONA 4 to integrate into a variety of workflows.

## KONA 4 Features Include:

- Supports 4K and UltraHD ingest and output at frame rates up to 50/60 fps
- Supports AJA Raw capture at 4K up to 120 fps via AJA Control Room
- Real time up-,down-,cross conversion with pristine 10-bit quality
- Mac, Windows and Linux support via AJA's Developer SDK
- 10-bit 4K/UltraHD and 2K/Dual-link/HD/SD input and output
- HDMI 1.4 output with additional support for UltraHD 50/60 fps 4:2:0
- 8-ch. AES/EBU, 8-ch. embedded HDMI, and 16-ch. embedded SDI digital audio I/O
- Supports 444 and 422 workflows
- Extend external connectivity with K3G-BOX breakout box option

# KONA 4

## Connections

**K3G-BOX Breakout Box**  
*(Optional)*

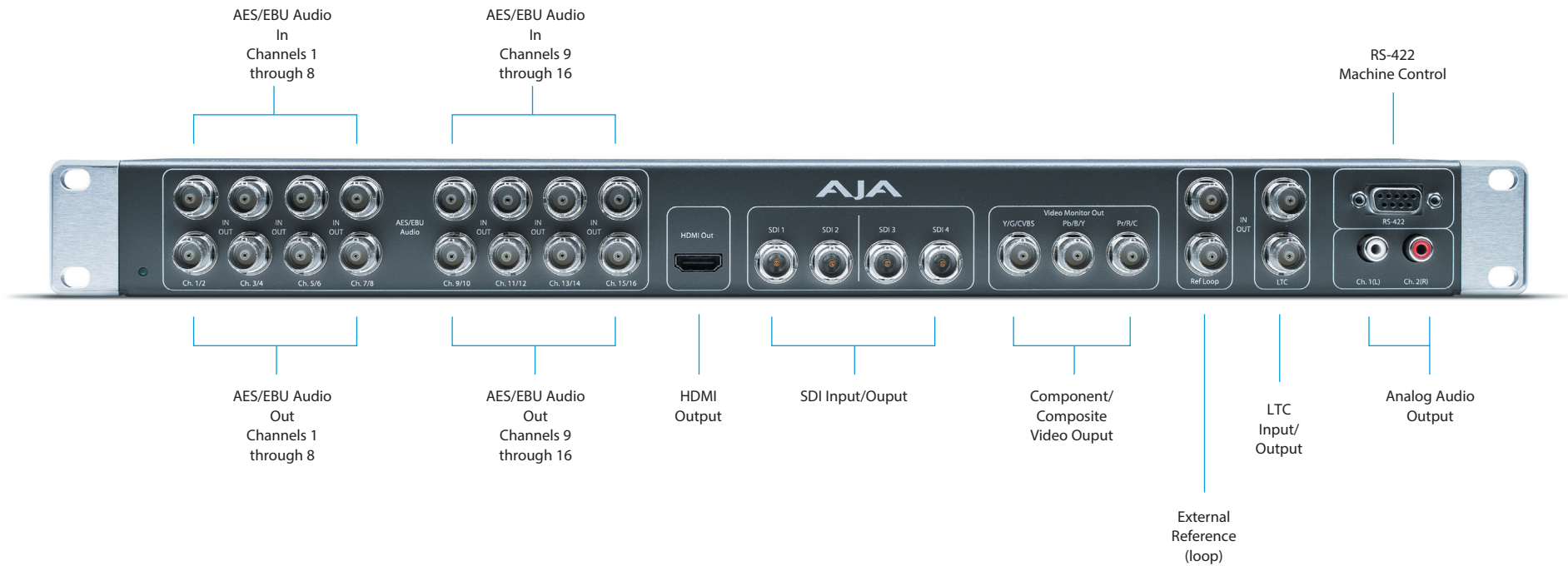

[Click here](#)

For full product specifications visit [www.aja.com/en/products/kona/#techspecs](http://www.aja.com/en/products/kona/#techspecs)

# KONA 4

## Connections

### Breakout cables (Supplied)

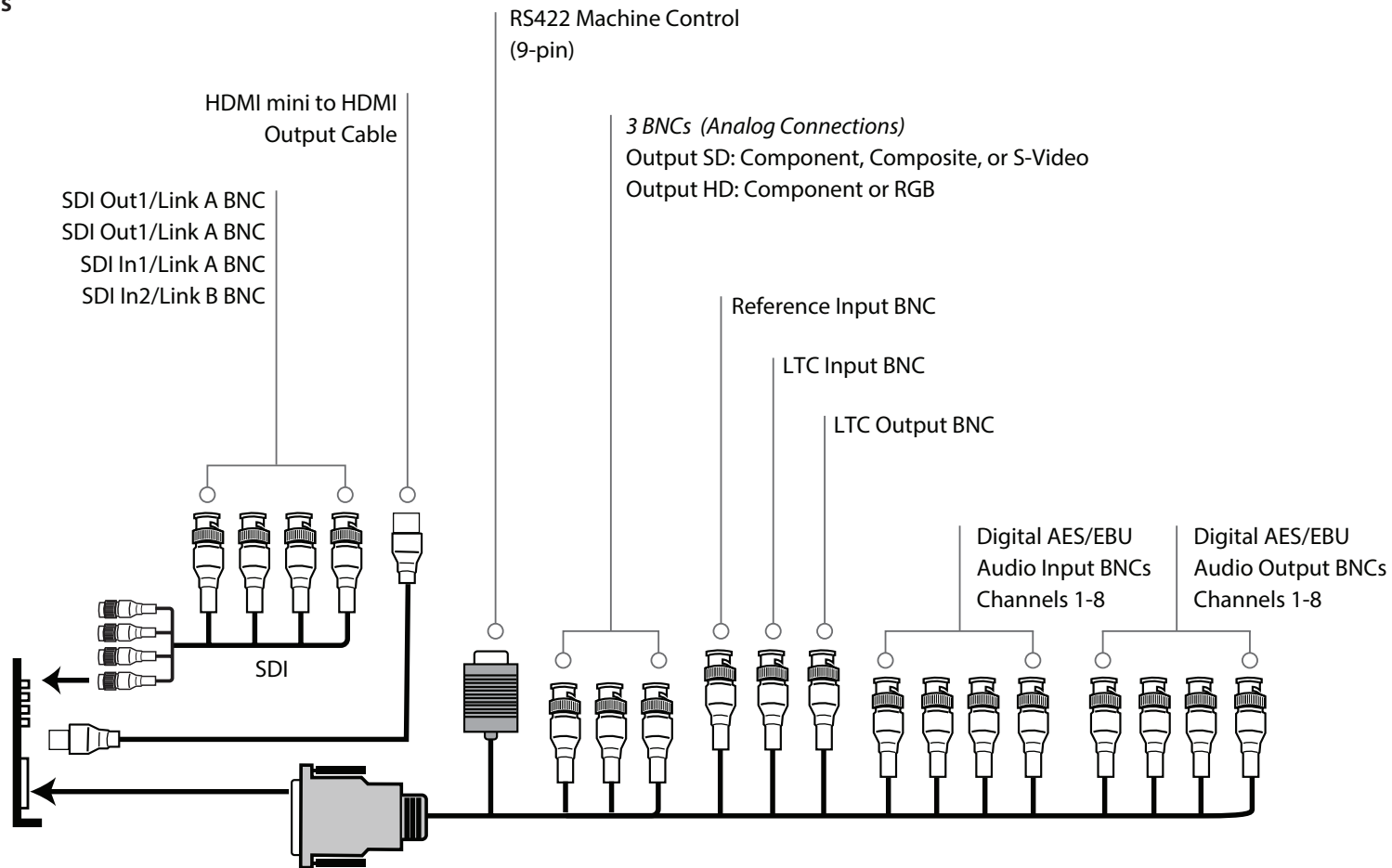

[Click here](#)

For full product specifications visit [www.aja.com/en/products/kona-4/#techspecs](http://www.aja.com/en/products/kona-4/#techspecs)



# KONA 4

## KONA-Powered Workflow

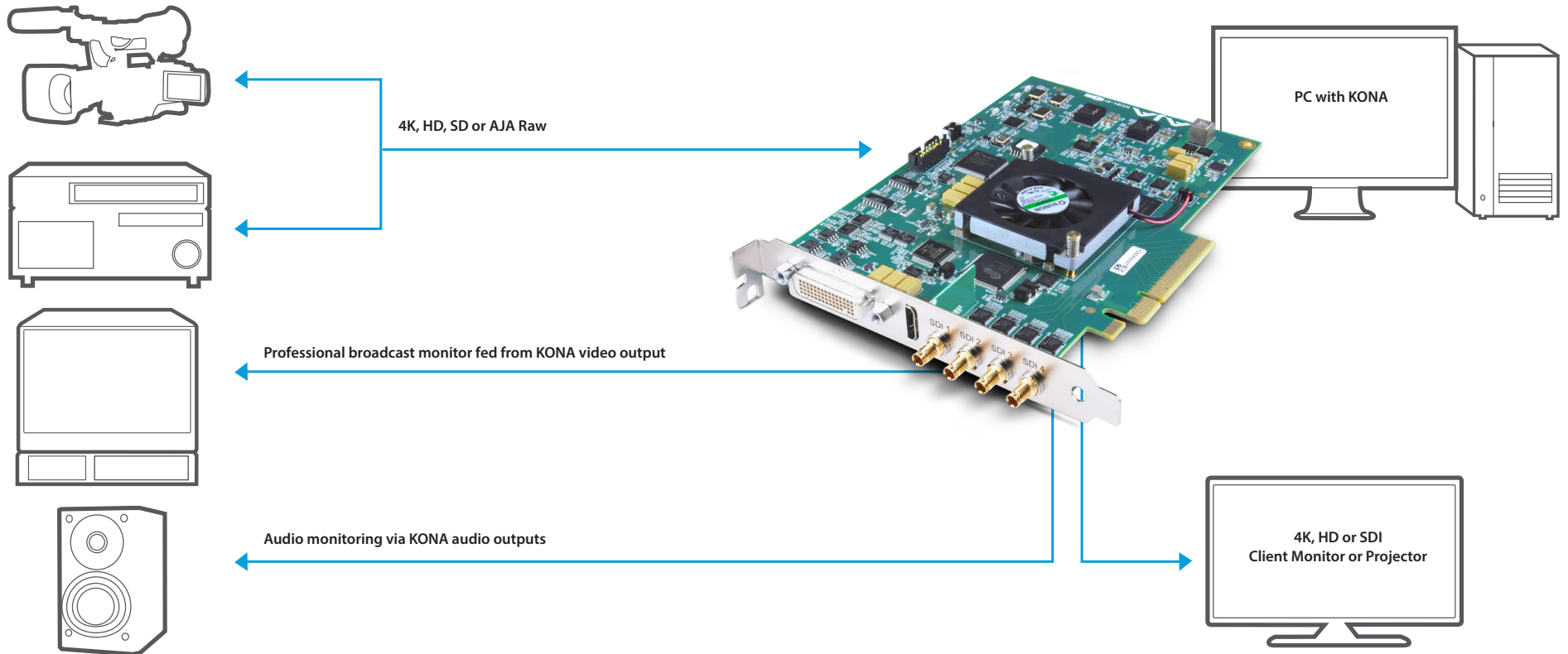

Connect your digital sources via SD/HD-SDI to KONA for capture and editing via a wide variety of formats.  
Master through high-quality professional SDI and Component outputs.

[Click here](#)

For full product specifications visit [www.aja.com/en/products/kona-4/#techspecs](http://www.aja.com/en/products/kona-4/#techspecs)

# KONA 4

## Tech Specs

### Video Formats

- 525i 29.97
- 525i 23.98\*
- 625i 25
- 720p 23.98\*, 24\*, 25\*, 29.97\*, 30\*, 50, 59.94, 60
- 1080i 25, 29.97, 30
- 1080PsF 23.98, 24, 25, 29.97, 30
- 1080p 23.98, 24, 25, 29.97, 30, 50, 59.94, 60
- 2048 x 1080P 23.98, 24, 25, 29.97, 30, 50, 59.94, 60
- 2048 x 1080PsF 23.98, 24, 25
- 2048 x 1556p 15, 14.98
- 2048 x 1556PsF 15, 23.98, 24
- 3840 x 2160P 23.98, 24, 25, 29.97, 50, 59.94, 60
- 4096 x 2160P 23.98, 24, 25, 50, 59.94, 60
- 3840 x 2160PsF 23.98, 24, 25
- 4096 x 2160PsF 23.98, 24, 25

\*These formats are dependent on specific software functionality and are not normal 'over-the-wire' formats.

### Video Input Digital

- 3G/SD/HD SDI, SMPTE-259/292/296/424, 8-bit, 10-bit and 12-bit\*
- Single Link 4:2:2 or 4:4:4 (1 x BNC)
- Dual Link HD 4:4:4 (2 x BNC)
- 2K HSDL (High Speed Data Link) 4:4:4, (2 x BNC)
- 4K/UltraHD
- AJA Raw
- 1D LUT Support

\*Bit-depth support is application-dependent. Check with your software manufacturer for compatibility.

### Video Output Digital

- 3G-SDI, SMPTE-259/292/296/424, 8-bit, 10-bit and 12-bit\*
- Single Link 4:2:2 or 4:4:4 (1 x BNC)
- Dual Link HD 4:4:4, (2 x BNC)
- 2K HSDL (High Speed Data Link) 4:4:4, (2 x BNC)
- 4K/UltraHD 4:2:2 and 4:4:4
- HDMI 1.4 with support for 2.0 Level B resolutions, 30/36 bits/pixel, RGB or YUV, 2.25Gbps, SD, HD and UHD with HFR support up to 60p 4:2:0

\*Bit-depth support is application-dependent. Check with your software manufacturer for compatibility.

### Video Output Analog

- Composite/S-Video (Y/C) (1 x BNC/2x BNC+adapter)
- NTSC, NTSCJ, PAL
- Component (3 x BNC)
- HD: YPbPr, RGB
- SD: YPbPr, RGB (component mode)
- SMPTE/EBU N10, Betacam 525 line, Betacam 525J, RGB
- 12-bit D/A, 8x oversampling
- +/- .2 dB to 5.0 MHz Y Frequency Response
- +/- .2 dB to 1 MHz C Frequency Response
- 5% 2T pulse response
- <1% Diff Phase
- <1% Diff Gain
- <1% ns Y/C delay inequity

### Frame Rate Conversion

- 4K/UHD - 60fps to 30fps
- 4K/UHD - 50fps to 25fps

### Downstream Keyer

Supports graphics with alpha channel over video, matte or framebuffer, or framebuffer content over incoming video or matte.

### Audio Input Digital

- 16-channel, 24-bit SDI embedded audio, 48kHz sample rate, Synchronous
- 8-channel, 24-bit AES/EBU audio, 48kHz sample rate, Synchronous or Non-synchronous, Internal sample rate conversion (via 4 x BNC on breakout cable)
- 16-channel, 24-bit AES/EBU audio, 48 kHz sample rate, Synchronous (via 8 x BNC on optional K3G-Box)

### Audio Output Digital

- 16-channel, 24-bit SDI embedded audio, 48kHz sample rate, Synchronous
- 8-channel, 24-bit HDMI embedded audio, 48kHz sample rate, Synchronous
- 8-channel, 24-bit AES/EBU audio, 48kHz sample rate, Synchronous or Non-synchronous, Internal sample rate conversion (via 4 x BNC on breakout cable)
- 16-channel, 24-bit AES/EBU audio, 48 kHz sample rate, Synchronous (via 8 x BNC on optional K3G-Box)

### Audio Output Analog

- 2-channel unbalanced output (via 2 x RCA jacks on optional K3G-Box)

[Click here](#)

For full product specifications visit [www.aja.com/en/products/kona-4/#techspecs](http://www.aja.com/en/products/kona-4/#techspecs)

(Continued on Next Page)



# KONA 4

## Tech Specs *(Continued)*

### Up-Conversion

---

- Hardware 10-bit
- Anamorphic: full-screen
- Pillar box 4:3: results in a 4:3 image in center of screen with black sidebars
- Zoom 14:9: results in a 4:3 image zoomed slightly to fill a 14:9 image with black side bars
- Zoom Letterbox: results in image zoomed to fill full screen
- Zoom Wide: results in a combination of zoom and horizontal stretch to fill a 16:9 screen; this setting can introduce a small aspect ratio change

### Down-Conversion

---

- Hardware 10-bit
- Anamorphic: full-screen
- Letterbox: image is reduced with black top and bottom added to image area with the aspect ratio preserved
- Crop: image is cropped to fit new screen size

### Cross-Conversion

---

- Hardware 10-bit
- 1080i to 720p
- 720p to 1080i
- 720p to 1080PsF

### SD to SD Aspect Ration Conversion

---

- Letterbox: This transforms SD anamorphic material to a letterboxed image.
- H Crop: Will produce a horizontally stretched effect on the image; transforms anamorphic SD to full frame
- SD Pillarbox: Will produce an image in the center of the screen with black borders on the left and right sides and an anamorphized image in the center
- V Crop: Will transform SD letterbox material to an anamorphic image.

### Timecode

---

- LTC timecode input and output (via 1 x BNC each)

### Reference Input

---

- Analog Color Black (1V) or Composite Sync (2 or 4V)
- Looping
- 75 ohm on optional K3G-Box, terminated on supplied breakout cable

### Machine Control

---

- RS-422, Sony 9-pin protocol (via breakout cable or optional K3G-Box)
- 9-pin D-connector pinout is as follows:

1	GND
2	RX-
3	TX+
4	GND
5	No Connection
6	GND

7	RX+
8	TX-
9	GND
Shell	GND

[Click here](#)

For full product specifications visit [www.aja.com/en/products/kona-4/#techspecs](http://www.aja.com/en/products/kona-4/#techspecs)



# KONA 3G

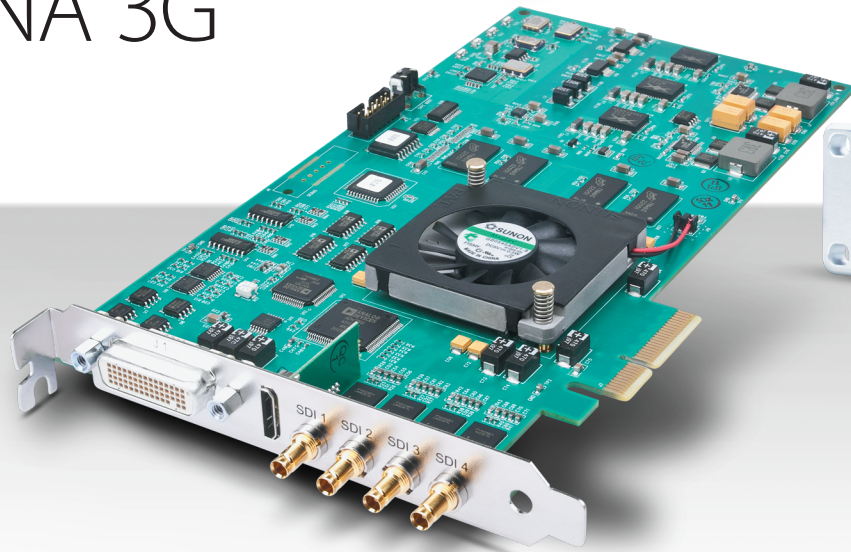

Only \$1,995 US MSRP\*

[Find a Reseller](#)

Ready for today's workflows and those of the future, KONA 3G gives video professionals unrivalled features and the highest standards in quality and performance.

## Professional Performance

**Top-of-the-line capabilities and quality make KONA 3G the go-to desktop I/O card.**

KONA 3G is a video and audio desktop I/O card that provides video professionals with unparalleled features for handling everything from SD to HD, 2K and 4K with full 10-bit uncompressed clarity. With a broadcast quality up-,down-,cross-converter and the ability to work in 3D, KONA 3G has the power for the work you do today and into the future.

KONA 3G offers users a single, powerful card with support for 4:2:2 and 4:4:4 color spaces to provide the highest quality for your images. The futureproof architecture means you can easily work with HD and 2K now and switch to working at 4K resolution when the need arises, even at frame rates up to 60 fps, without the requirement for new hardware. KONA 3G supports Dual Link 4:4:4 HD-SDI, with full-bandwidth 4:4:4 RGB at 10-bits for 1080i, 1080p, 1080PsF and 720p formats. KONA 3G can also convert between 4:4:4 and 4:2:2 formats for single link HD-SDI monitoring and output.

For SDI video, KONA 3G features two 3G/HD/SD inputs and two outputs. HDMI 1.4a monitoring output, LTC I/O, Genlock input and

configurable 3 x BNC SD/HD analog video output. Switch KONA 3G into 4K mode and all four BNC connections can be used for 4K capture or output.

KONA 3G's extensive 4K support allows output directly from editing systems to 4K projectors or monitors, including HFR support at 50/60 fps and 4K HDMI output to support the latest UltraHD monitors, allowing editors and clients to view full resolution 4K images as they work. This output capability enables a powerful 4K workflow that is also affordable and manageable.

The built-in up-,down-, cross-converter brings any video to a unified resolution, simplifying workflows and eliminating the need to adjust resolution within software. KONA 3G also includes a powerful hardware downstream keyer that can place graphic files with an alpha channel, selectable color matte or the contents of the card's frame buffer over the video being input to the card.

# KONA 3G

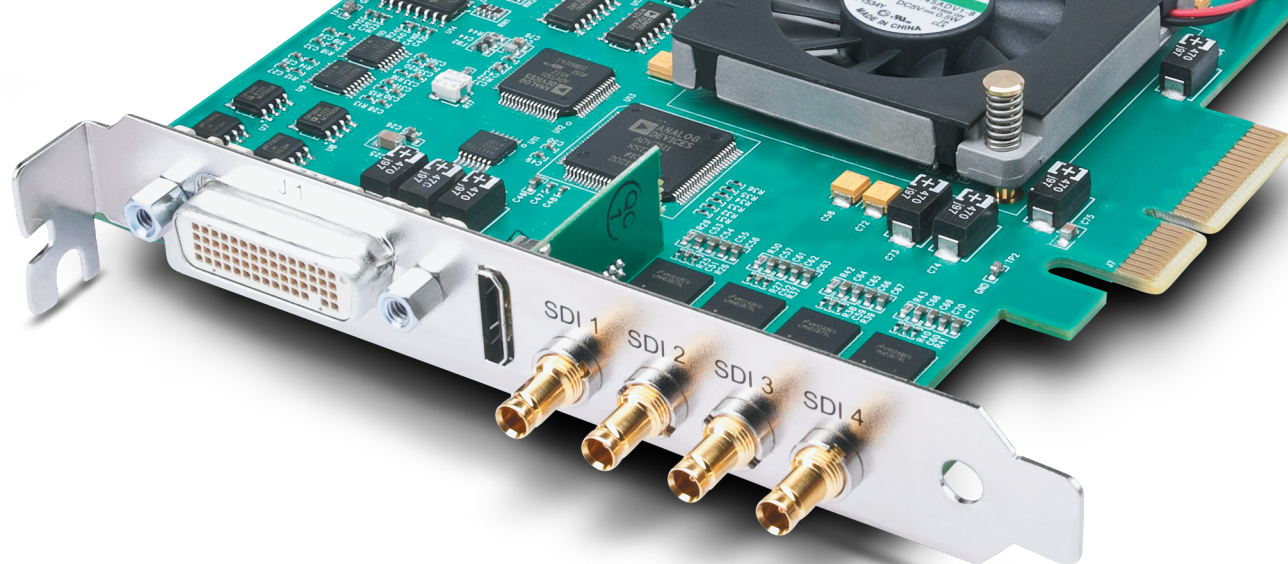

## From SD to 4K in a single card

KONA 3G is futureproof, allowing you to easily work in HD and 2K and switch to working at 4K resolution without the need for additional or new hardware.

Leading the way for quality 4K capture, monitoring and output, KONA 3G offers 4K in both YCbCr and RGB. When 4K mode is selected, the four SDI connectors are remapped as I/O for handling the four quadrants of a 4K picture, providing support for most standard 4K formats.



## Integrated AJA hardware conversion

KONA 3G features full 10-bit, broadcast-quality, motion-adaptive SD to HD up conversion, HD to HD cross conversion, HD to SD down conversion, and automatic SD/HD 12-bit component analog output.

Since all conversion functionality on the KONA 3G is hardware-based, it's available on ingest or playback.

Uniquely, the KONA 3G can cross convert 720p 23.98 to 1080PsF 23.98. Cross conversion is particularly valuable in today's multiformat HD post environment where producing pristine 720p or 1080i signals at-will helps streamline dailies and deliverables.



## Extend your Connectivity

The optional K3G-Box breakout box and cables allow KONA 3G to integrate easily into rack environments, enabling quick access to all video and audio connections without having to get at the back of the tower computer. Additional K3G-Box functionality over the standard breakout cable comes in the form of eight additional AES audio channels, 2-channel RCA analog audio monitoring jacks, and looping BNC Genlock reference connectors.

# KONA 3G

## Connections

### K3G-BOX Breakout Box (Optional)

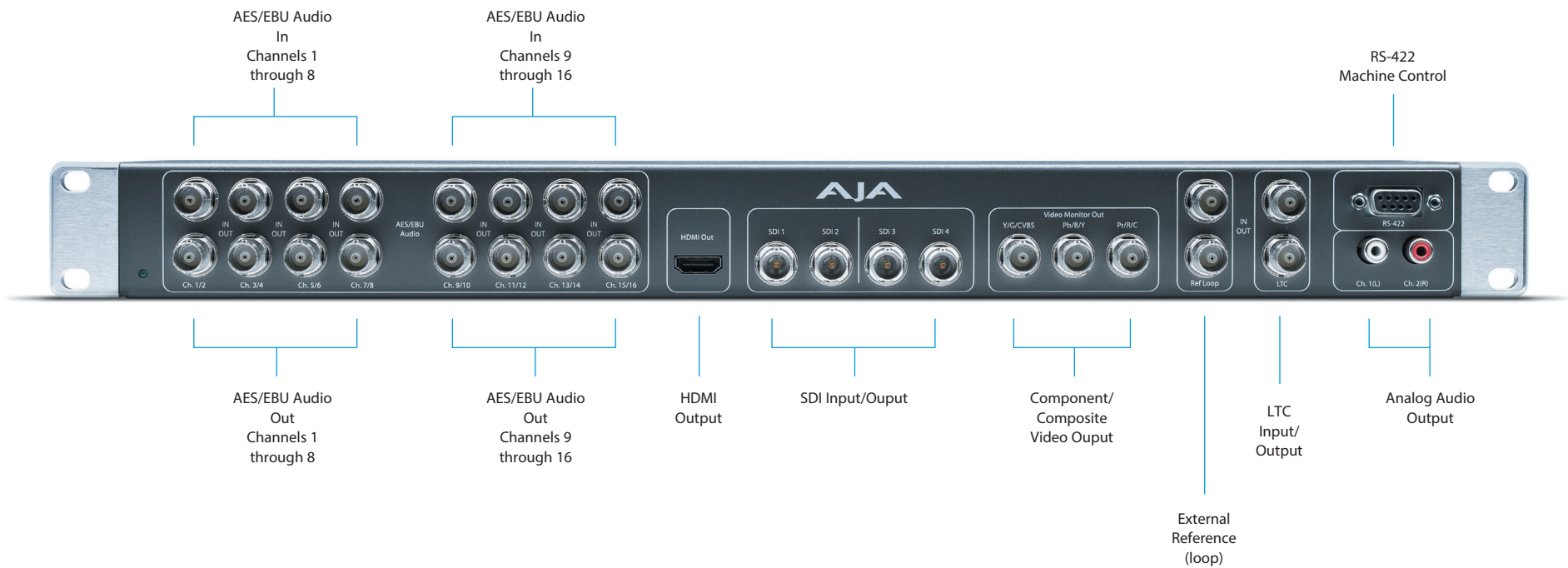

[Click here](#)

For full product specifications visit [www.aja.com/en/products/kona/#techspecs](http://www.aja.com/en/products/kona/#techspecs)



# KONA 3G

## Connections

**Breakout cables**  
(Supplied)

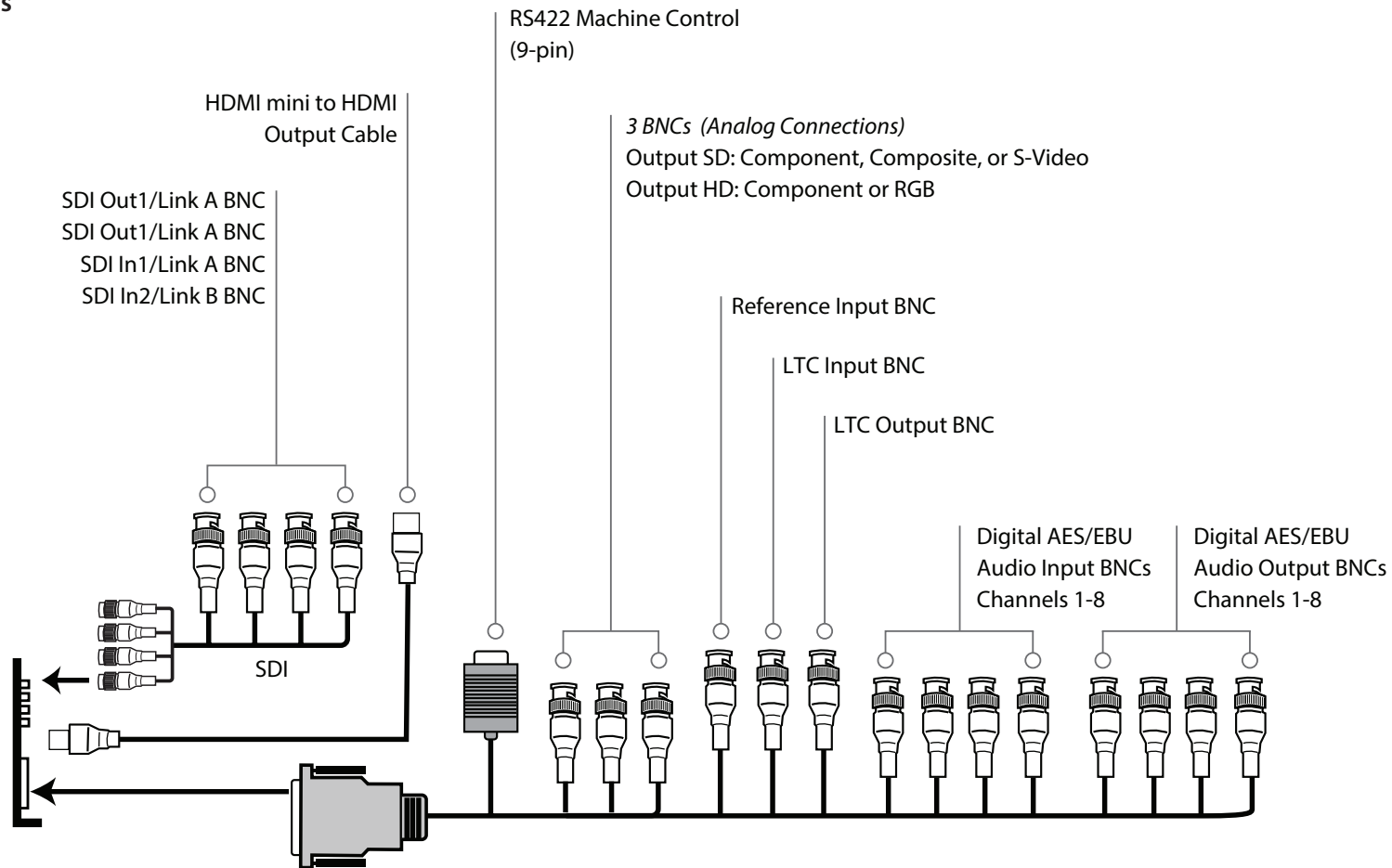

[Click here](#)

For full product specifications visit [www.aja.com/en/products/kona-3g/#techspecs](http://www.aja.com/en/products/kona-3g/#techspecs)

# KONA 3G

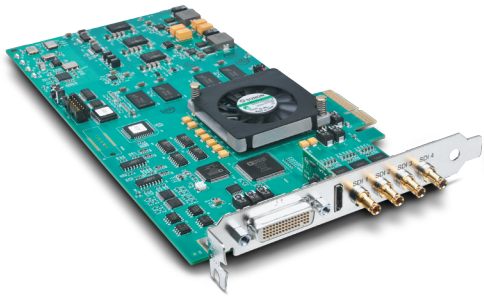

## Zoic Bridges Remote Facilities and Paves a Path to 4K with AJA KONA 3G

*"KONA 3G is the backbone of high quality image communication between Zoic Vancouver and Zoic Culver City."*

In addition to a steady stream of feature, games and commercial projects, Zoic is currently handling VFX for television shows *Falling Skies*, *Once Upon a Time* and *Wonderland*, all shot using virtual sets. The company is also venturing into 4K post-production within their commercial division for the Intel and Toshiba webisode series, "The Power Within.". For reliable and efficient collaboration across remote facilities, Zoic relies on AJA's KONA 3G cards to help facilitate live synchronized sessions using Tweak's RV-SDI playback and review software.

"KONA 3G is the backbone of high quality image communication between Zoic Vancouver and Zoic Culver City," said Mike Romey, Zoic Studios Head of Pipeline. "Using the RV-SDI integration, we queue up media in the projection rooms at each location for synced up dailies sessions where teams of artists can review and annotate shots in real time with supervisors at full resolution."

Zoic's projection rooms are setup to view HD, 2K and 4K dailies, and are frequently tapped to finalize upwards of 400 VFX shots for each episode, and workflow reliability is paramount. During review, files are opened in Tweak Software's RV image and sequence viewer, using a custom front end to record dailies into Shotgun Software's web-based production management platform. Since up to 50 artists and supervisors across both locations might be contributing to a project, Zoic's KONA 3G-powered workflow allows producers to compare and contrast different versions of any given shot to ensure appropriate edits and design choices are implemented during session reviews. "We can do instant playback projection to easily show things like the last CG render of the most recent lighting pass. There is constant

iterating, and being able to present changes in real time with the KONA 3G is incredibly valuable," noted Romey.

While a majority of Zoic's deliverables are in HD, the studio's commercial division is currently working on webisode content in 4K for Intel and Toshiba. Implementing a 4K pipeline proved to be a fairly straightforward task because of Zoic's existing infrastructure. The studio uses the KONA 3G cards with The Foundry's HIERO collaborative shot management solution for plate prep, Autodesk® Flame® editorial and color grading software for final conform and finishing, along with RV-HDSDI for review.

Romey explained, "We didn't have to retool our workflow for 4K reviews. We already had a high bandwidth to route content to the KONA 3G card from our servers and RV supports 4K so it was just a matter of adjusting the projector."

Zoic's impressive television credits include *True Blood*, *Once Upon a Time*, *Fringe*, *Wonderland*, and *Intelligence* as well as *Falling Skies* and *Hemlock Grove*, which feature work nominated for the 2013 Outstanding Visual Effects Emmy Award®. Considering the volume and scheduling demands of episodic work, Zoic is currently deploying editorial improvements to ensure utmost quality on delivered shots. An early adopter of HIERO, Zoic deploys 25 licenses of the software, with most workstations running KONA 3G on display monitors to do live I/O from the conform. Connecting via HDMI and with help from HIERO, the KONA 3G card has even enabled stereo 3D dailies for a recent feature film project.

[View Online](#)

# KONA 3G

## Workflow

### KONA-powered workflows

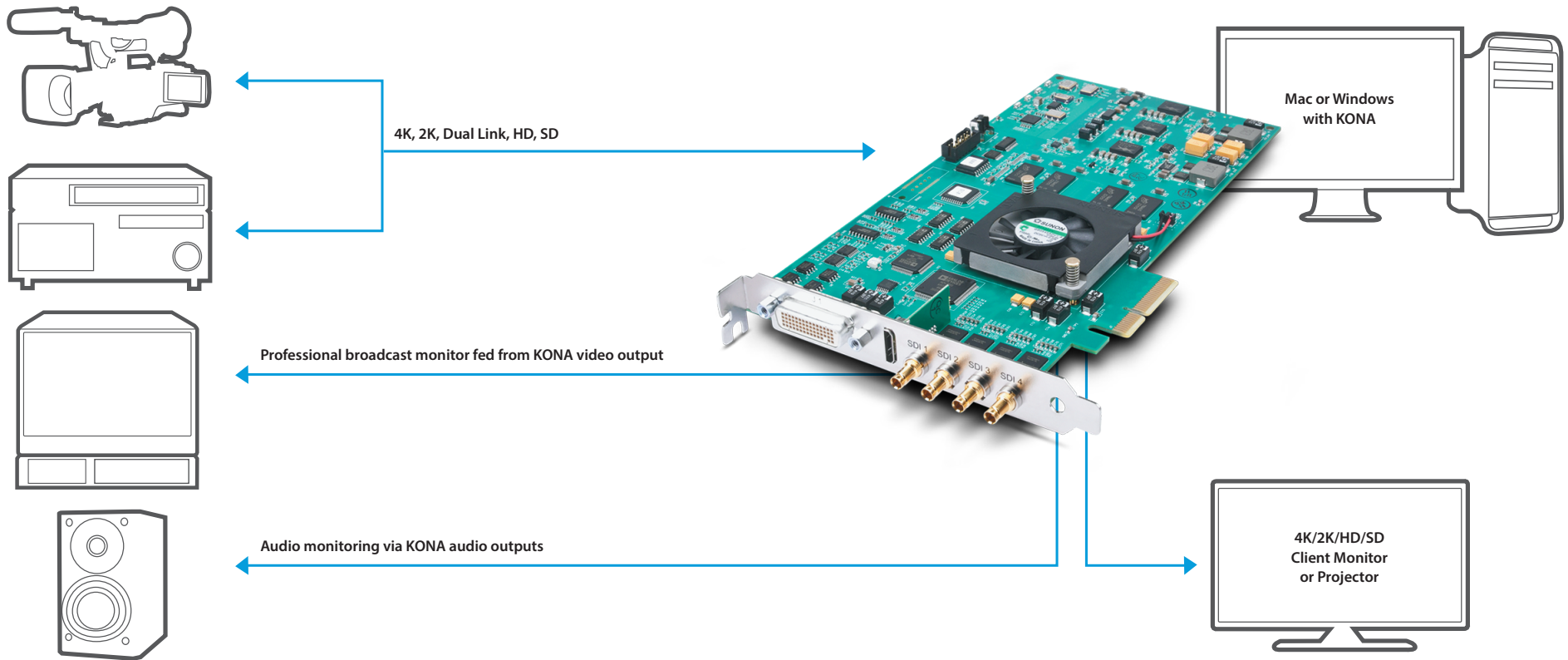

Connect your digital sources via SD/HD-SDI or HDMI to KONA for capture and editing via a wide variety of formats. Master to any Digital or Analog device through high-quality professional SDI, HDMI or Component outputs.

# KONA 3G

## Tech Specs

### Video Formats

- 525i 29.97
- 525i 23.98\*
- 625i 25
- 720p 23.98\*, 24\*, 25\*, 29.97\*, 30\*, 50, 59.94, 60
- 1080i 25, 29.97, 30
- 1080PsF 23.98, 24, 25, 29.97, 30
- 1080p 23.98, 24, 25, 29.97, 30, 50, 59.94, 60
- 2048 x 1080P 23.98, 24, 25, 29.97, 30, 50, 59.94, 60
- 2048 x 1080PsF 23.98, 24, 25
- 2048 x 1556p 15, 14.98
- 2048 x 1556PsF 15, 23.98, 24
- 3840 x 2160P 23.98, 24, 25, 29.97, 30
- 4096 x 2160P 23.98, 24, 25, 29.97, 30
- 3840 x 2160PsF 23.98, 24, 25
- 4096 x 2160PsF 23.98, 24, 25

\* These formats are dependent on specific software functionality and are not normal 'over-the-wire' formats.

### Video Input Digital

- 3G/SD/HD SDI, SMPTE-259/292/296/424, 8- or 10-bits
- Single Link 4:2:2 or 4:4:4 (1 x BNC)
- Dual Link HD 4:4:4 (2 x BNC)
- 2K HSDL (High Speed Data Link) 4:4:4, (2 x BNC)
- 4K/Ultra HD
- 1D LUT Support

### Video Output Digital

- 3G/SD/HD SDI, SMPTE-259/292/296/424
- Single Link 4:2:2 or 4:4:4 (1 x BNC)
- Dual Link HD 4:4:4, (2 x BNC)
- 2K HSDL (High Speed Data Link) 4:4:4, (2 x BNC)
- 4K/QuadHD 4:2:2 and 4:4:4
- HDMI 1.4 up to 1920x1080

### Video Output Analog

- Composite/S-Video (Y/C) (1 x BNC/2x BNC+adapter)
- NTSC, NTSCJ, PAL
- Component (3 x BNC)
- HD: YPbPr, RGB
- SD: YPbPr, RGB (component mode)
- SMPTE/EBU N10, Betacam 525 line, Betacam 525J, RGB
- 12-bit D/A, 8x oversampling
- +/- .2 dB to 5.0 MHz Y Frequency Response
- +/- .2 dB to 1 MHz C Frequency Response
- 5% 2T pulse response
- <1% Diff Phase
- <1% Diff Gain
- <1% ns Y/C delay inequity

### Downstream Keyer

Supports graphics with alpha channel over video, matte or framebuffer, or framebuffer content over incoming video or matte.

### Audio Input Digital

- 16-channel, 24-bit SDI embedded audio, 48kHz sample rate, Synchronous
- 8-channel, 24-bit AES/EBU audio, 48kHz sample rate, Synchronous or Non-synchronous, Internal sample rate conversion (via 4 x BNC on breakout cable)
- 16-channel, 24-bit AES/EBU audio, 48 kHz sample rate, Synchronous (via 8 x BNC on optional K3G-Box)

### Audio Output Digital

- 16-channel, 24-bit SDI embedded audio, 48kHz sample rate, Synchronous
- 8-channel, 24-bit HDMI embedded audio, 48kHz sample rate, Synchronous
- 8-channel, 24-bit AES/EBU audio, 48kHz sample rate, Synchronous or Non-synchronous, Internal sample rate conversion (via 4 x BNC on breakout cable)
- 16-channel, 24-bit AES/EBU audio, 48 kHz sample rate, Synchronous (via 8 x BNC on optional K3G-Box)

### Audio Output Analog

- 2-channel unbalanced output (via 2 x RCA jacks on optional K3G-Box)

[Click here](#)

For full product specifications visit [www.aja.com/en/products/kona-3g/#techspecs](http://www.aja.com/en/products/kona-3g/#techspecs)

(Continued on Next Page)





# KONA 3G

## Tech Specs *(Continued)*

### Up-Conversion

---

- Hardware 10-bit
- Anamorphic: full-screen
- Pillar box 4:3: results in a 4:3 image in center of screen with black sidebars
- Zoom 14:9: results in a 4:3 image zoomed slightly to fill a 14:9 image with black side bars
- Zoom Letterbox: results in image zoomed to fill full screen
- Zoom Wide: results in a combination of zoom and horizontal stretch to fill a 16:9 screen; this setting can introduce a small aspect ratio change

### Down-Conversion

---

- Hardware 10-bit
- Anamorphic: full-screen
- Letterbox: image is reduced with black top and bottom added to image area with the aspect ratio preserved
- Crop: image is cropped to fit new screen size

### Cross-Conversion

---

- Hardware 10-bit
- 1080i to 720p
- 720p to 1080i
- 720p to 1080PsF

### SD to SD Aspect Ration Conversion

---

- Letterbox: This transforms SD anamorphic material to a letterboxed image.
- H Crop: Will produce a horizontally stretched effect on the image; transforms anamorphic SD to full frame
- SD Pillarbox: Will produce an image in the center of the screen with black borders on the left and right sides and an anamorphized image in the center
- V Crop: Will transform SD letterbox material to an anamorphic image.

### Timecode

---

- LTC timecode input and output (via 1 x BNC each)

### Reference Input

---

- Analog Color Black (1V) or Composite Sync (2 or 4V)
- Looping
- 75 ohm on optional K3G-Box, terminated on supplied breakout cable

### Machine Control

---

- RS-422, Sony 9-pin protocol (via breakout cable or optional K3G-Box)
- 9-pin D-connector pinout is as follows:

1	GND
2	RX-
3	TX+
4	GND
5	No Connection
6	GND
7	RX+
8	TX-
9	GND
Shell	GND

[Click here](#)

For full product specifications visit [www.aja.com/en/products/kona-3g/#techspecs](http://www.aja.com/en/products/kona-3g/#techspecs)

# KONA LHi

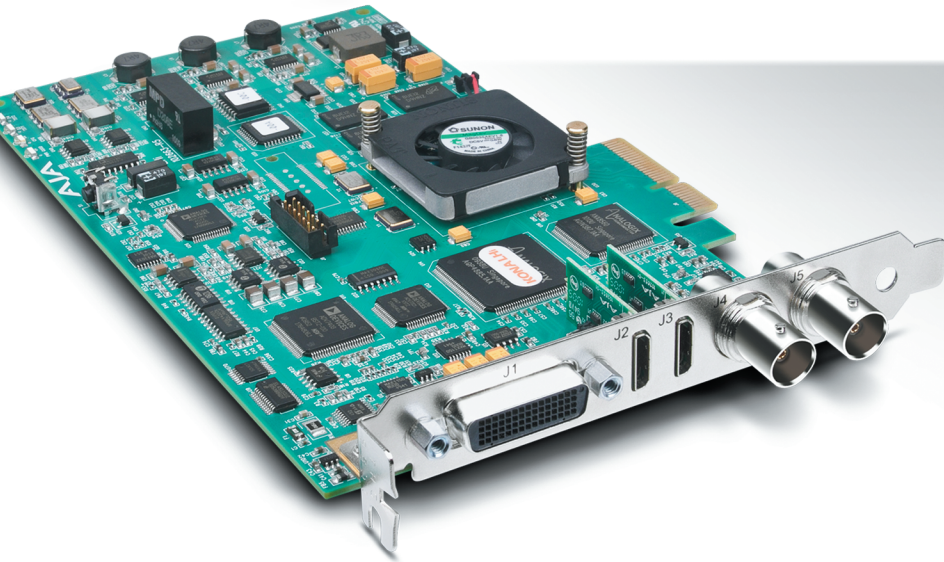

Only \$1,495 US MSRP\*

[Find a Reseller](#)

The most flexible card for analog and digital Standard and High Definition workflows.

## Multi-format analog and digital I/O

**KONA LHi provides the maximum compatibility for diverse workflows.**

If your post-production facility works with a wide variety of formats, frame rates and audio/video sources, the KONA LHi provides the connectivity you need, bridging the gap between analog devices and the latest 3G SDI and HDMI enabled products to provide editing, monitoring and mastering of professional quality video in an affordable, powerful, easy to use product.

Connecting to everything from an HDMI enabled camera to an HD-SDI VTR, KONA LHi offers a full host of no-compromise features, including 10-bit or 8-bit uncompressed video, 2-channel AES digital audio and 8-channel SDI embedded digital audio, analog composite or S-video or SD/HD component video I/O, 2-channel balanced analog audio I/O, and broadcast-quality hardware-based up-,down-,cross-conversion for flexible SD and HD post production. KONA LHi supports a full HDMI workflow with 10-bit 'deep color' output for the best image quality possible. HDMI signals can also be converted to SDI for use in more professional environments.

KONA LHi features full 10-bit, broadcast quality, motion-adaptive SD to HD up-conversion, HD to HD cross-conversion, HD to SD down-conversion, and automatic HD/SD 12-bit component analog output. Since KONA LHi's conversions are hardware-based, they are available all the time - during ingest or playback. Outputs can be configured independently allowing you to have simultaneous HD and SD output - or two different types of HD: 720 or 1080 - output at the same time via cross-conversion.

In addition to a full set of video and audio I/O, KONA LHi can lock to external reference signals, accept timecode in and out and control a variety of tape decks via the industry standard RS-422 9-pin connection.



Utilize the KLHi-BOX Breakout Box to easily integrate KONA LHi into rackmount environments.

# KONA LHi

## Workflow

### KONA-powered workflows

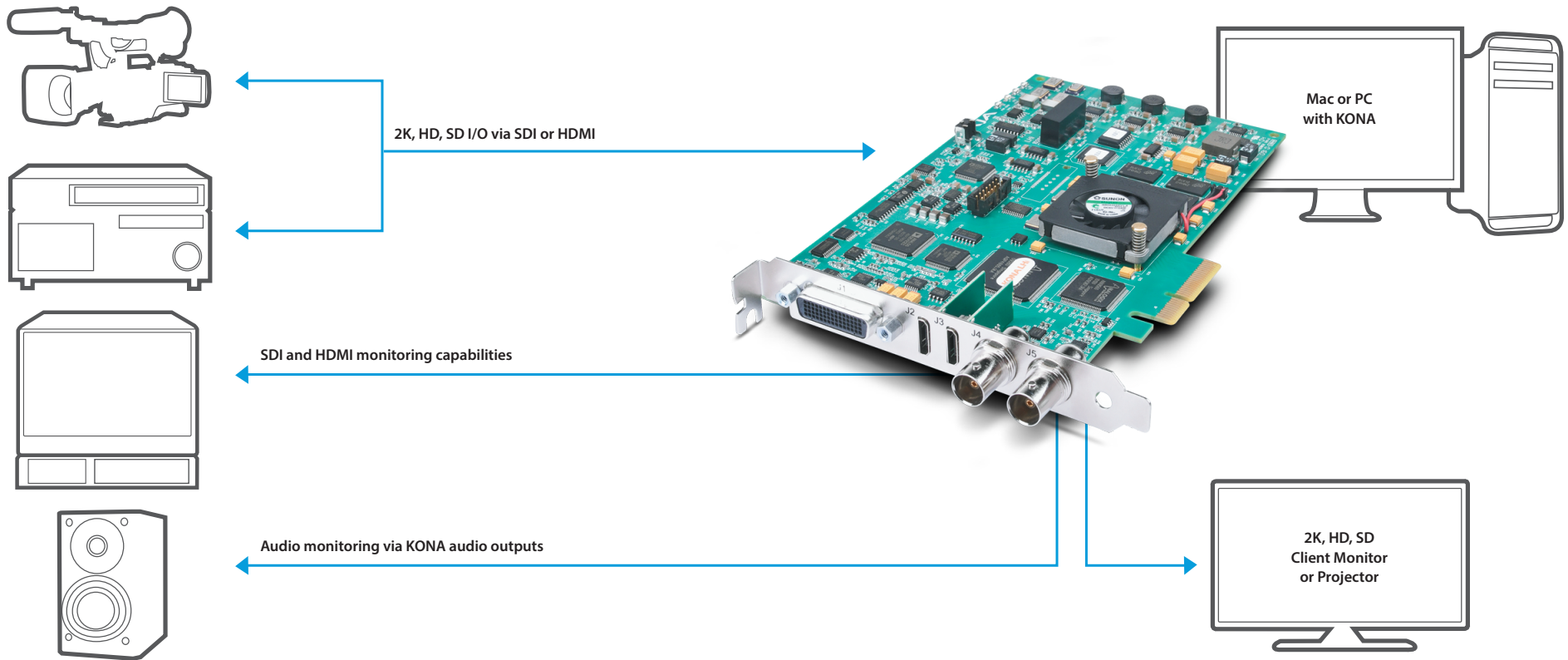

Connect your digital sources via SD/HD-SDI or HDMI to KONA for capture and editing via a wide variety of formats. Master to any Digital or Analog device through high-quality professional SDI, HDMI or Component outputs.

# KONA LHi

## Connections

**KLHI-BOX Breakout Box**  
(Optional)

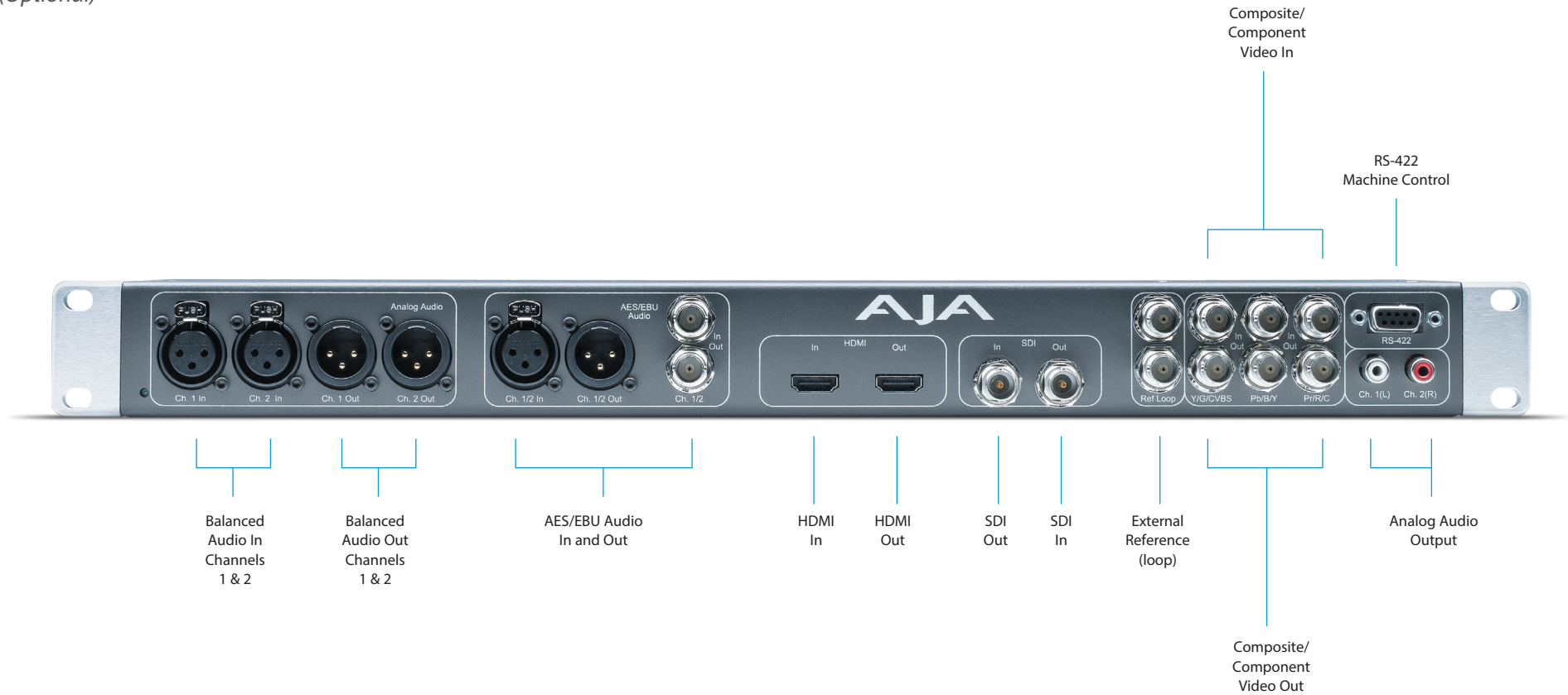

[Click here](#)

For full product specifications visit [www.aja.com/en/products/kona-lhi/#techspecs](http://www.aja.com/en/products/kona-lhi/#techspecs)



# KONA LHi

## Connections

### Breakout cables (Supplied)

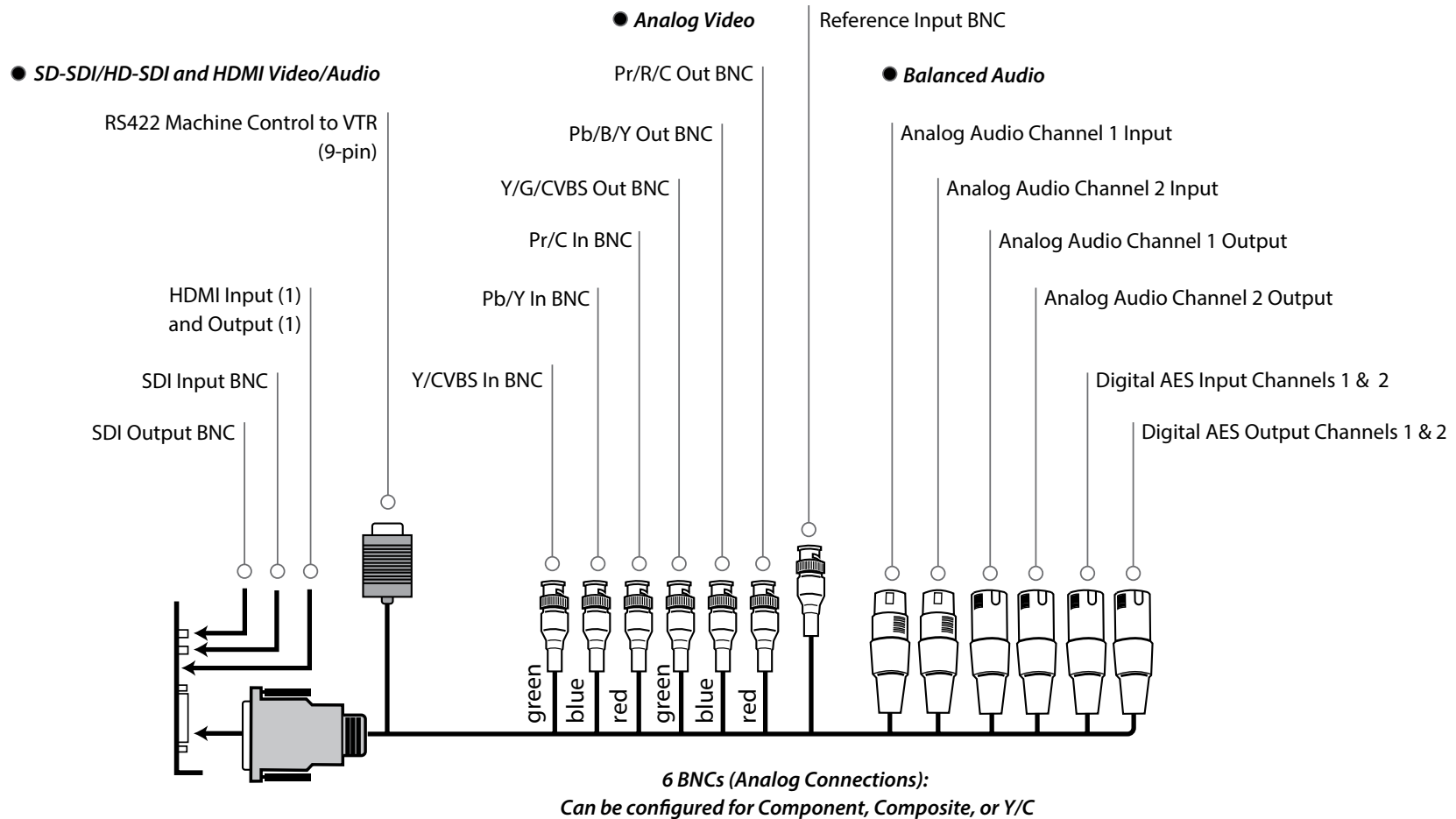

[Click here](#)

For full product specifications visit [www.aja.com/en/products/kona-lhi/#techspecs](http://www.aja.com/en/products/kona-lhi/#techspecs)

# KONA LHi

## Tech Specs

### Video Formats

- 525i 23.98\*, 29.97
- 625i 25
- 720p 23.98\*, 50, 59.94, 60
- 1080i 25, 29.97, 30
- 1080PsF 23.98, 24
- 1080p 23.98, 24, 25, 29.97, 30, 50, 59.94, 60
- 2048 x 1080P 23.98, 24, 25, 29.97, 30
- 2048 x 1080PsF 23.98, 24

\*These formats are dependent on specific software functionality and are not normal 'over-the-wire' formats.

### Software-dependent Formats

These formats are dependent on specific software functionality and are not normal 'over-the-wire' formats.

- 525i, 23.98
- 720P 23.98

### Video Input Digital

- 3G/SD/HD SDI, SMPTE-259/292/296/424, 8- or 10-bits
- Single Link 4:2:2 (1 x BNC)
- HDMI v1.3 30 bits/pixel, RGB or YUV, 2.25 Gbps, SD, HD, 1080p-50/60

### Video Input Analog

- Composite/S-Video (Y/C) (1 x BNC/2x BNC+adapter)
- NTSC, NTSCJ, PAL
- Component (3 x BNC)
- HD: YPbPr, RGB
- SD: YPbPr, RGB (component mode)
- SMPTE/EBU N10, Betacam 525 line, Betacam 525J, RGB
- 12-bit D/A, 8x oversampling
- +/- .2 dB to 5.0 MHz Y Frequency Response
- +/- .2 dB to 1 MHz C Frequency Response
- .5% 2T pulse response
- <1% Diff Phase
- <1% Diff Gain
- <1 ns Y/C delay inequity

### Video Output Digital

- 3G/SD/HD SDI, SMPTE-259/292/296/424
- Single Link 4:2:2 or 4:4:4 (1 x BNC)
- HDMI v1.3 30 bits/pixel, RGB or YUV, 2.25 Gbps, SD, HD, 1080p-50/60

### Video Output Analog

- Composite/S-Video (Y/C) (1 x BNC/2x BNC)
- NTSC, NTSCJ, PAL
- 12-bit D/A, 8x oversampling
- +/- .2 dB to 5.0 MHz Y Frequency Response
- +/- .2 dB to 1 MHz C Frequency Response
- .5% 2T pulse response
- <1% Diff Phase
- <1% Diff Gain
- Component (3 x BNC)
- HD: YPbPr, RGB
- SD: YPbPr, RGB (component mode)
- SMPTE/EBU N10, Betacam 525 line, Betacam 525J, RGB
- 12-bit D/A, 8x oversampling
- +/- .2 dB to 5.5 MHz Y Frequency Response
- +/- .2 dB to 2.5 MHz C Frequency Response
- .5% 2T pulse response
- <1 ns Y/C delay inequity

### Audio Input Digital

- 8-channel, 24-bit SDI embedded audio, 48kHz sample rate, Synchronous
- 8-channel, 24-bit HDMI embedded audio, 48kHz sample rate, Synchronous
- 2-channel, 24-bit AES/EBU audio, 48kHz sample rate, Synchronous or Non-synchronous, Internal sample rate conversion (via 1 x XLR on breakout cable or optional KLHi-Box)

### Audio Input Analog

- 2-channel, 24-bit A/D analog audio, 48kHz sample rate, balanced (via 2 x XLR on breakout cable or optional KLHi-Box)
- +24 dBu Full Scale Digital
- +/- 0.2 dB 20Hz to 20kHz Frequency Response

### Audio Output Digital

- 8-channel, 24-bit SDI embedded audio, 48kHz sample rate, Synchronous
- 8-channel, 24-bit HDMI embedded audio, 48kHz sample rate, Synchronous
- 2-channel, 24-bit AES/EBU audio, 48kHz sample rate, Synchronous or Non-synchronous, Internal sample rate conversion (via 1 x XLR on breakout cable or optional KLHi-Box)

### Audio Output Analog

- 2-channel, 24-bit D/A analog audio, 48kHz sample rate, balanced (via 2 x XLR on breakout cable or optional KLHi-Box)
- +24 dBu Full Scale Digital (0 dBFS)
- +/- 0.2 dB 20Hz to 20kHz Frequency Response
- 2-channel unbalanced output (via 2 x RCA jacks on optional KLHi-Box)

[Click here](#)

For full product specifications visit [www.aja.com/en/products/kona-lhi/#techspecs](http://www.aja.com/en/products/kona-lhi/#techspecs)

(Continued on Next Page)

# KONA LHi

## Tech Specs *(Continued)*

### Up-Conversion

---

- Hardware 10-bit
- Anamorphic: full-screen
- Pillar box 4:3: results in a 4:3 image in center of screen with black sidebars
- Zoom 14:9: results in a 4:3 image zoomed slightly to fill a 14:9 image with black side bars
- Zoom Letterbox: results in image zoomed to fill full screen
- Zoom Wide: results in a combination of zoom and horizontal stretch to fill a 16:9 screen; this setting can introduce a small aspect ratio change

### Down-Conversion

---

- Hardware 10-bit
- Anamorphic: full-screen
- Letterbox: image is reduced with black top and bottom added to image area with the aspect ratio preserved
- Crop: image is cropped to fit new screen size

### Cross-Conversion

---

- Hardware 10-bit
- 1080i to 720P
- 720P to 1080i
- 720P to 1080PsF

### SD to SD Aspect Ration Conversion

---

- Letterbox: This transforms SD anamorphic material to a letterboxed image.
- H Crop: Will produce a horizontally stretched effect on the image; transforms anamorphic SD to full frame
- SD Pillarbox: Will produce an image in the center of the screen with black borders on the left and right sides and an anamorphized image in the center
- V Crop: Will transform SD letterbox material to an anamorphic image.

### Reference Input

---

- Analog Color Black (1V) or Composite Sync (2 or 4V)
- Looping
- 75 ohm on optional KLHi-Box, terminated on supplied breakout cable

### Machine Control

---

- RS-422, Sony 9-pin protocol (via breakout cable or optional KLHi-Box)
- 9-pin D-connector pinout is as follows:

1	GND
2	RX-
3	TX+
4	GND
5	No Connection
6	GND
7	RX+
8	TX-
9	GND
Shell	GND

[Click here](#)

For full product specifications visit [www.aja.com/en/products/kona-lhi/#techspecs](http://www.aja.com/en/products/kona-lhi/#techspecs)

# KONA LHe Plus

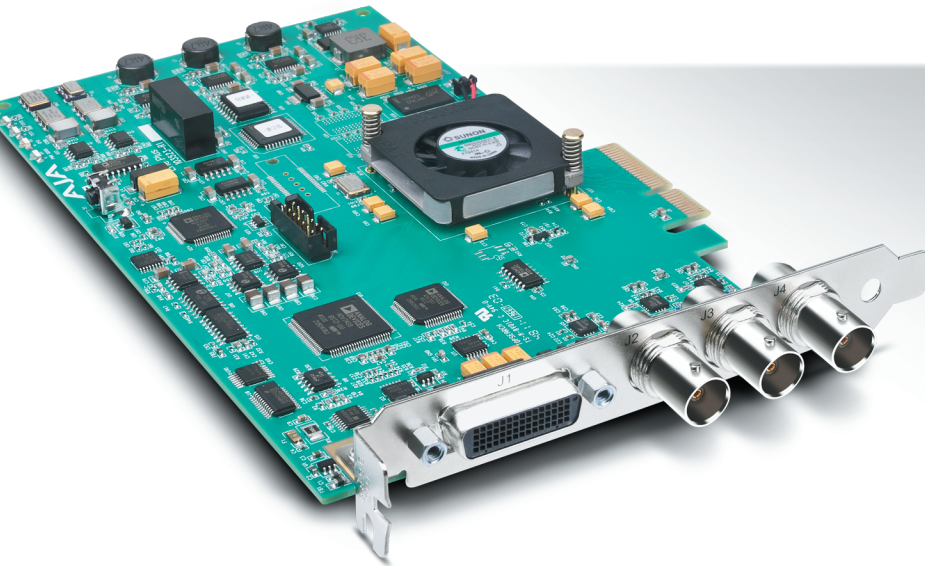

Only \$995 US MSRP\*

[Find a Reseller](#)

Powerful video and audio I/O with a full set of no-compromise features for video professionals.

## Affordable, flexible KONA power

**Add the power of AJA's KONA I/O to your system for high-quality capture and output that fits within any budget.**

KONA LHe Plus offers video professionals at all levels an affordable desktop I/O solution that doesn't compromise on quality or essential functionality and features.

KONA LHe Plus supports both SD/HD analog and digital I/O for video and audio, providing maximum capability in a single card, simplifying integrating analog and digital signals into a single workflow and provides multiple output options to ensure you can deliver whatever formats are required.

For SDI video, the KONA LHe Plus features one input and two outputs and can be configured independently for HD or SD. It offers Genlock input, and three BNCs which may be configured for analog video input and output (HD or SD). Also included is a 9-pin connector for RS-422 machine control. Because the KONA LHe Plus supports 12-bit analog component HD input and output, devices with analog HD output, such as decks and even game consoles, can be connected for a variety of workflows.

The broadcast-quality down-converter in the LHe Plus allows it to connect to analog SD devices for output. This can be used to check framing and color for SD versions while still working in full resolution HD within your application, ensuring proper quality for multi-format deliveries. Since conversion is hardware-based, it's available during ingest or playback.

Like all KONA cards, LHe Plus connectivity can be extended via the KL-Box-LH breakout box, enabling simple integration into rack environments, with quick access to all video and audio connections and additional AES/EBU audio connectivity without having to access the back of the computer tower.



Utilize the KL-BOX-LH Breakout Box to easily integrate KONA LHe Plus into rackmount environments.



# KONA LHe Plus

## Connections

**KL-BOX-LH Breakout Box**  
*(Optional)*

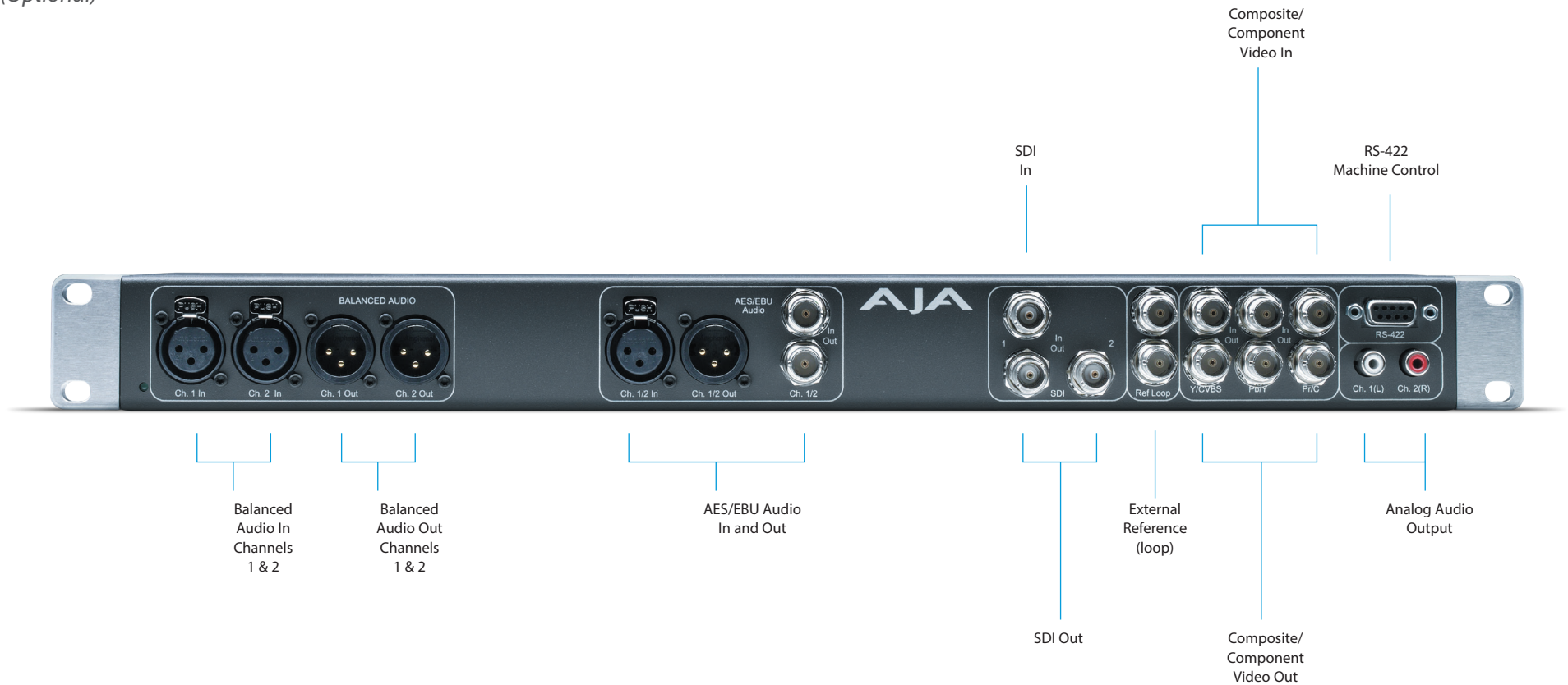

[Click here](#)

For full product specifications visit [www.aja.com/en/products/kona-lhe-plus/#techspecs](http://www.aja.com/en/products/kona-lhe-plus/#techspecs)

# KONA LHe Plus

## Connections

**Breakout cables**  
(Supplied)

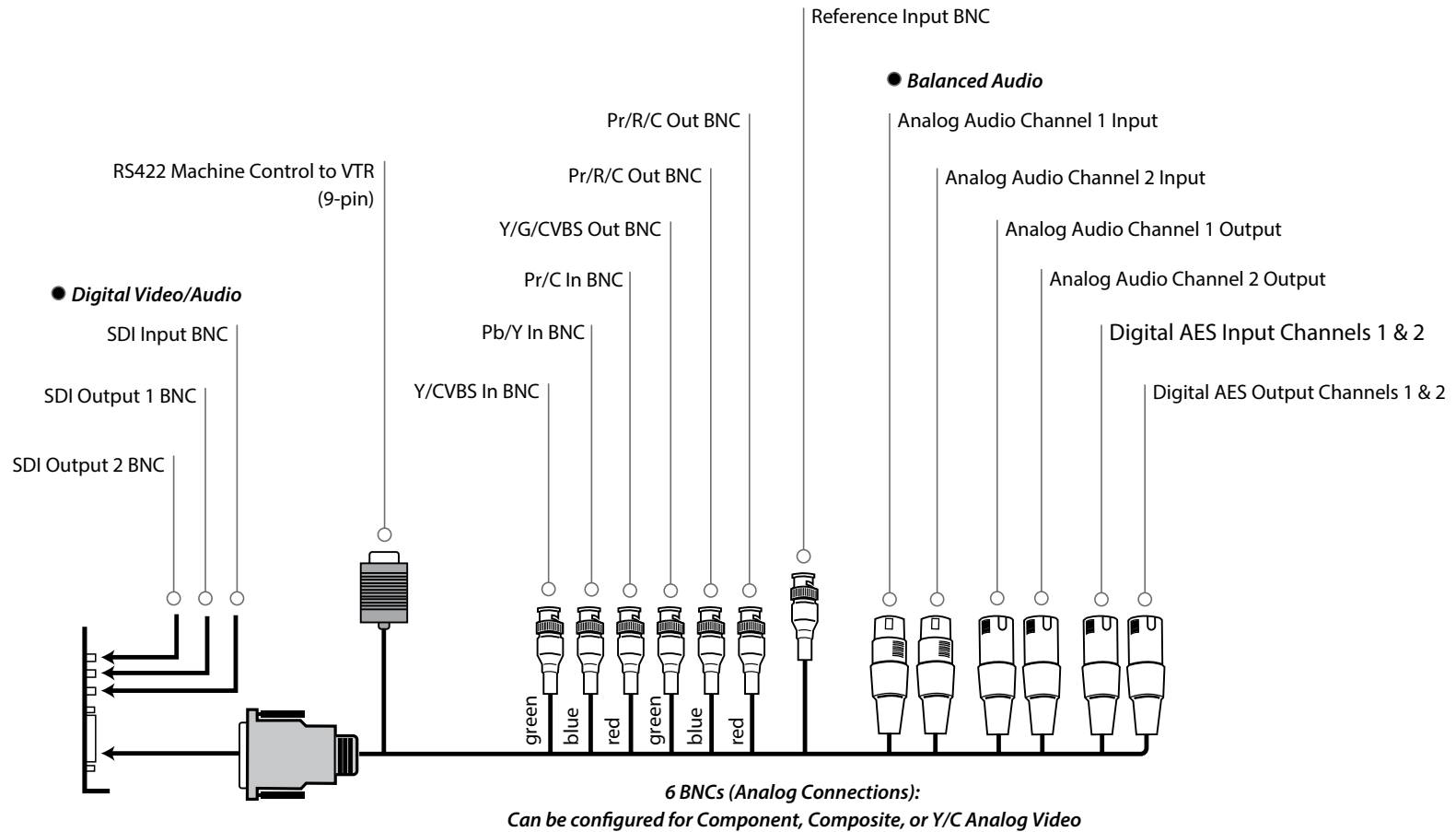

[Click here](#)

For full product specifications visit [www.aja.com/en/products/kona-lhe-plus/#techspecs](http://www.aja.com/en/products/kona-lhe-plus/#techspecs)

# KONA LHe Plus

## Workflow

### KONA-powered workflows

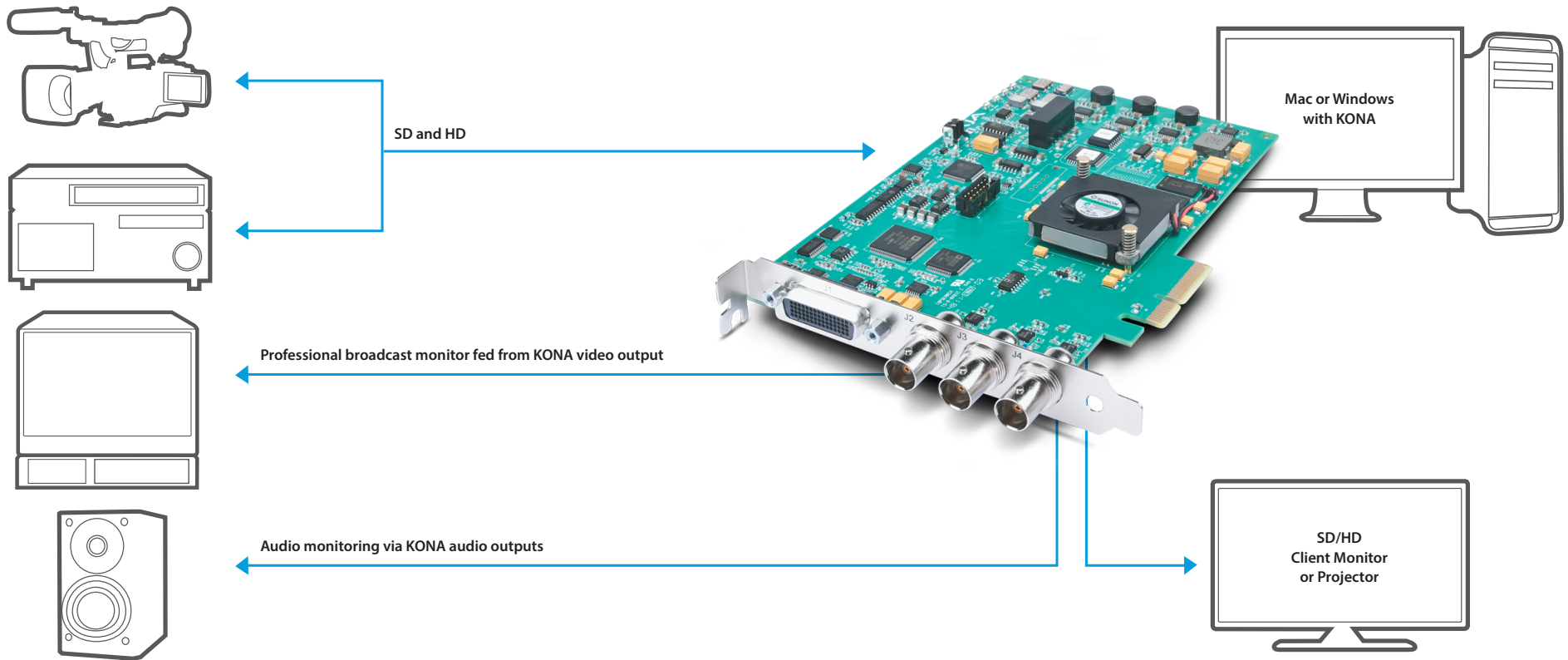

Connect your digital sources via SD/HD-SDI to KONA for capture and editing via a wide variety of formats.  
Master through high-quality professional SDI and Component outputs.

# KONA LHe Plus

## Tech Specs

### Video Formats

- 525i 29.97
- 625i 25
- 720p 50, 59.94, 60
- 1080i 25, 29.97, 30
- 1080PsF 23.98, 24, 25, 29.97, 30
- 1080p 23.98, 24, 25, 29.97, 30

### Video Input Digital

- SD/HD SDI, SMPTE-259/292/296, 8- or 10-bits
- Single Link 4:2:2 (1 x BNC)

### Video Input Analog

- Composite/S-Video (Y/C) (1 x BNC/2x BNC+adapter)
- NTSC, NTSCJ, PAL
- Component (3 x BNC)
- HD: YPbPr, RGB
- SD: YPbPr, RGB (component mode)
- SMPTE/EBU N10, Betacam 525 line, Betacam 525J, RGB
- 12-bit D/A, 2x oversampling
- +/- .2 dB to 5.0 MHz Y Frequency Response
- +/- .2 dB to 1 MHz C Frequency Response
- .5% 2T pulse response
- <1% Diff Phase
- <1% Diff Gain
- <1 ns Y/C delay inequity

### Video Output Digital

- SD SDI, SMPTE-259M, 10-bit
- HD SDI, SMPTE-292/296, 10-bit

### Video Output Analog

- Composite/S-Video (Y/C) (1 x BNC/2x BNC+adapter)
- NTSC, NTSCJ, PAL
- Component (3 x BNC)
- HD: YPbPr, RGB
- SD: YPbPr, RGB (component mode)
- SMPTE/EBU N10, Betacam 525 line, Betacam 525J, RGB
- 12-bit D/A, 8x oversampling
- +/- .2 dB to 5.0 MHz Y Frequency Response
- +/- .2 dB to 1 MHz C Frequency Response
- .5% 2T pulse response
- <1% Diff Phase
- <1% Diff Gain
- <1 ns Y/C delay inequity

### Audio Input Digital

- 8-channel, 24-bit SDI embedded audio, 48kHz sample rate, Synchronous
- 2-channel, 24-bit AES/EBU audio, 48kHz or 96 KHz sample rate, Synchronous or Non-synchronous, Internal sample rate conversion (via 1 x XLR on breakout cable or optional KL-BOX-LH)

### Audio Input Analog

- 2-channel, 24-bit A/D analog audio, 48kHz sample rate, balanced (via 2 x XLR on breakout cable or optional KL-BOX-LH)
- +24 dBu Full Scale Digital
- +/- 0.2 dB 20 to 20kHz Frequency Response

### Audio Output Digital

- 8-channel, 24-bit SDI embedded audio, 48kHz sample rate, Synchronous
- 2-channel, 24-bit AES/EBU audio, 48kHz or 96 KHz sample rate, Synchronous or Non-synchronous, Internal sample rate conversion (via 1 x XLR on breakout cable or optional KL-BOX-LH)

### Audio Output Analog

- 2-channel, 24-bit D/A analog audio, 48kHz sample rate, balanced (via 2 x XLR on breakout cable or optional KL-Box)
- +24 dBu Full Scale Digital (0 dBFS)
- +/- 0.2 dB 20Hz to 20kHz Frequency Response
- 2-channel unbalanced output (via 2 x RCA jacks on optional KL-BOX-LH)

### Down-Conversion

- Hardware 10-bit
- Anamorphic: full-screen
- Letterbox: image is reduced with black top and bottom added to image area with the aspect ratio preserved
- Crop: image is cropped to fit new screen size

### Reference Input

- Analog Color Black (1V) or Composite Sync (2 or 4V)
- Looping
- 75 ohm on optional KL-BOX-LH, terminated on supplied breakout cable

### Machine Control

- RS-422, Sony 9-pin protocol (via breakout cable or optional KL-BOX-LH)
- 9-pin D-connector pinout is as follows:

1	GND
2	RX-
3	TX+
4	GND
5	No Connection
6	GND
7	RX+
8	TX-
9	GND
Shell	GND

[Click here](#)

For full product specifications visit [www.aja.com/en/products/kona-lhe-plus/#techspecs](http://www.aja.com/en/products/kona-lhe-plus/#techspecs)



### 3-year warranty

AJA Video warrants that KONA products will be free from defects in materials and workmanship for a period of three years from the date of purchase.

### About AJA Video Systems, Inc.

Since 1993, AJA Video has been a leading manufacturer of video interface and conversion solutions, bringing high-quality, cost-effective digital video products to the professional, broadcast and post-production markets.

AJA products are designed and manufactured at our facilities in Grass Valley, California, and sold through an extensive sales channel of resellers and systems integrators around the world. For further information, please see our website at [www.aja.com](http://www.aja.com)

Because it matters.®

AJA Video Systems, Inc.  
Grass Valley, California  
[www.aja.com](http://www.aja.com) • [sales@aja.com](mailto:sales@aja.com) • [support@aja.com](mailto:support@aja.com)

