

**TYPICAL INSTALLATION FOR ALL T3U TABLE BOXES**

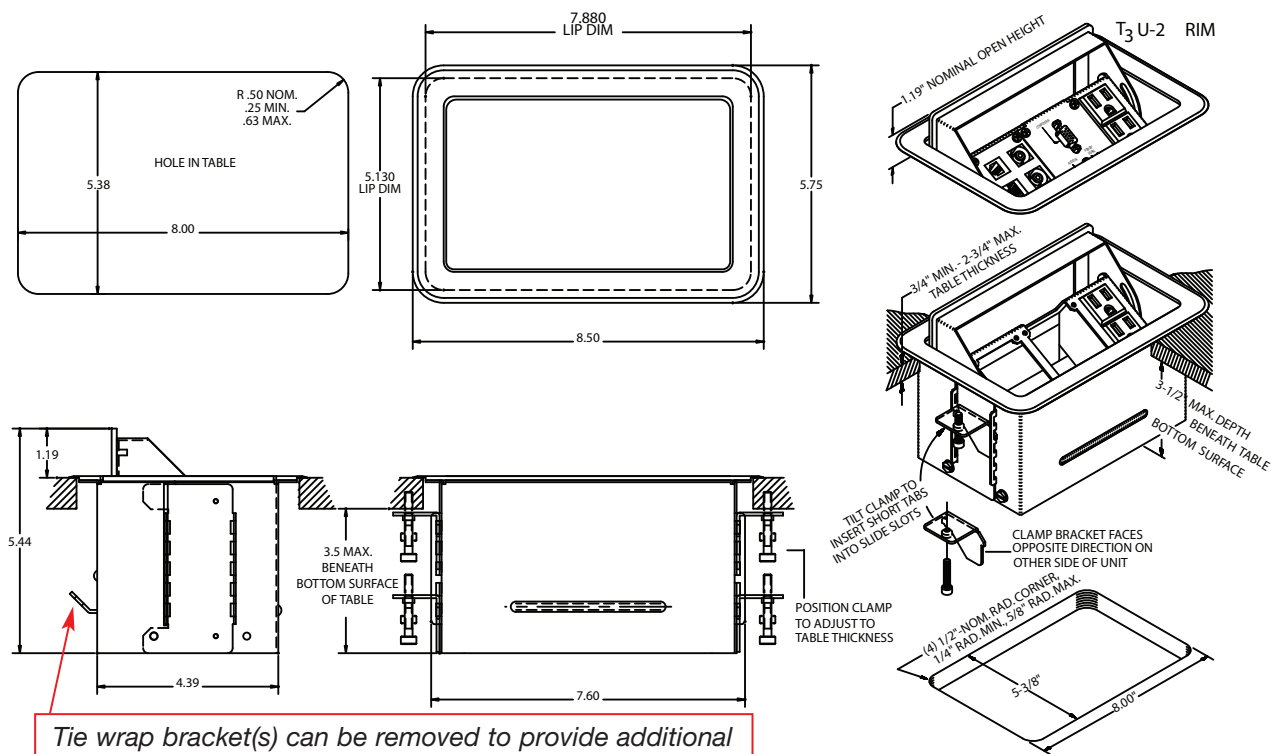

Tie wrap bracket(s) can be removed to provide additional connector clearance.

NOTE: T3U-1 and T3U-2 models have a 6' NEMA 5-15 SJ cordset. The T3U-3 model has a 9' NEMA 5-20 SJ cordset.

**SIMILAR FSR PRODUCT OFFERINGS**

The T3-AC2 and T3-PC1D are perfect table boxes for single users, where convenient access to network drops, ac power sources and video/audio displays are required. The small footprint provides an unobtrusive complement to any decor.



**T3-AC2**

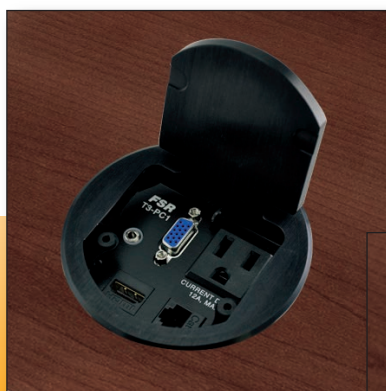

**T3-PC1D**



Specifications are subject to change without notice.



244 Bergen Boulevard, Woodland Park, NJ 07424  
 Phone: 973.785.4347 · Fax: 973.785.4207  
 Web: www.fsrinc.com · E-mail: sales@fsrinc.com

**T3U Rim Series  
 Table Top Tilt Up Boxes**

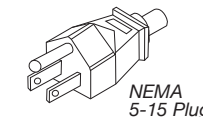

**T3U-1R-BRS**  
 (Shown with accessory plates and connectors.)

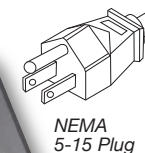

**T3U-2R-BLK**

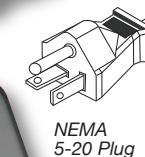

**T3U-3R-BLK**  
 (Shown with accessory plates and connectors.)

**Introducing FSR's expanded line of table box solutions...**

The T3U RIM Series (Table Top Tilt Up) table boxes.

Designed expressly for applications requiring multiple access boxes within the same table, the FSR T3U RIM Series handles data, power, and AV connections in a low profile box.

You can match almost any decor with the T3U RIM Series cover finish selection. Colors include Black, brushed Brass or brushed Nickel. The T3U RIM Series easily installs in any table surface with thickness ranging from a minimum .75" to a maximum of 2.75". In the open position, the T3U RIM Series cover protrudes a mere 1.19" from the table top. Under the table, the T3U RIM Series extends only 4.25" from the table top surface.

The FSR T3U RIM Series offer a variety of connection schemes through the use of interchangeable snap in connectors and mounting plates. This allows the plates to be populated by the installer and can be changed as the need arises. FSR offers a complete line of connectors and plates to satisfy most installation requirements. (See options on the following pages.)

NOTE: T3U-1 and T3U-2 models have a 6' NEMA 5-15 SJ cordset. The T3U-3 model has a 9' NEMA 5-20 SJ cordset.

**FSR Inc.**

244 Bergen Boulevard, Woodland Park, NJ 07424  
 Phone: 973.785.4347 · Fax: 973.785.420  
 Web: www.fsrinc.com · E-mail: sales@fsrinc.com



**T3U-1**

**T3U-1**  
Connector Plate View

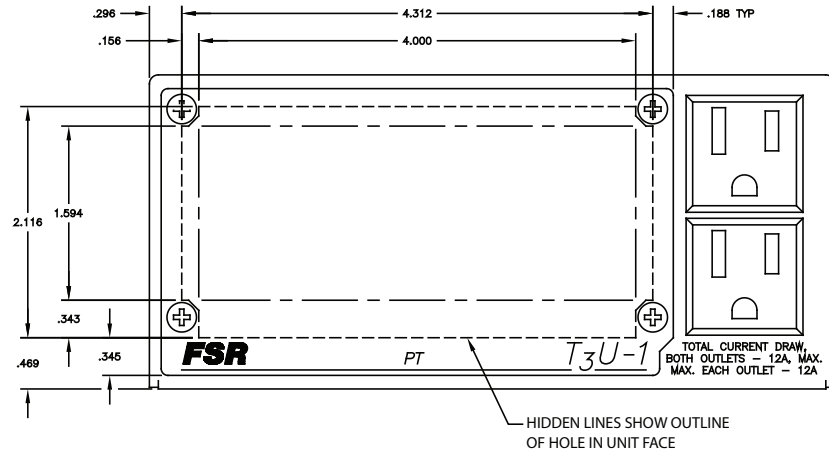
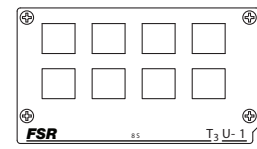
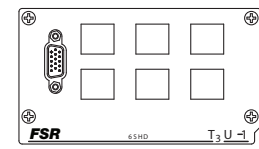
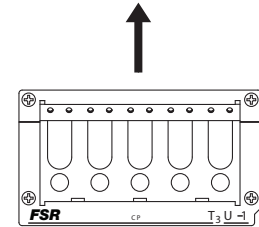
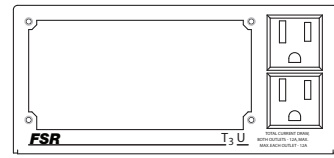

**T3U-2**

Connector Plate View

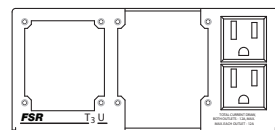

Left Plate Options

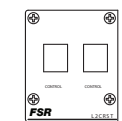
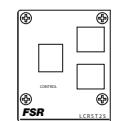
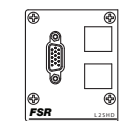
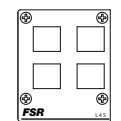
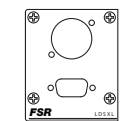
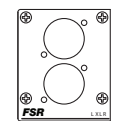
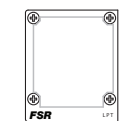
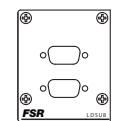
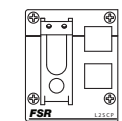
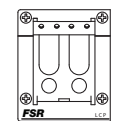

Right Plate Options

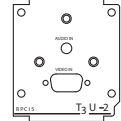
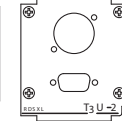
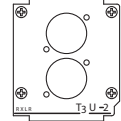
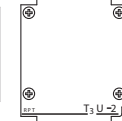
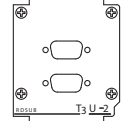
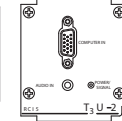
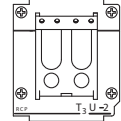

**T3U-2**

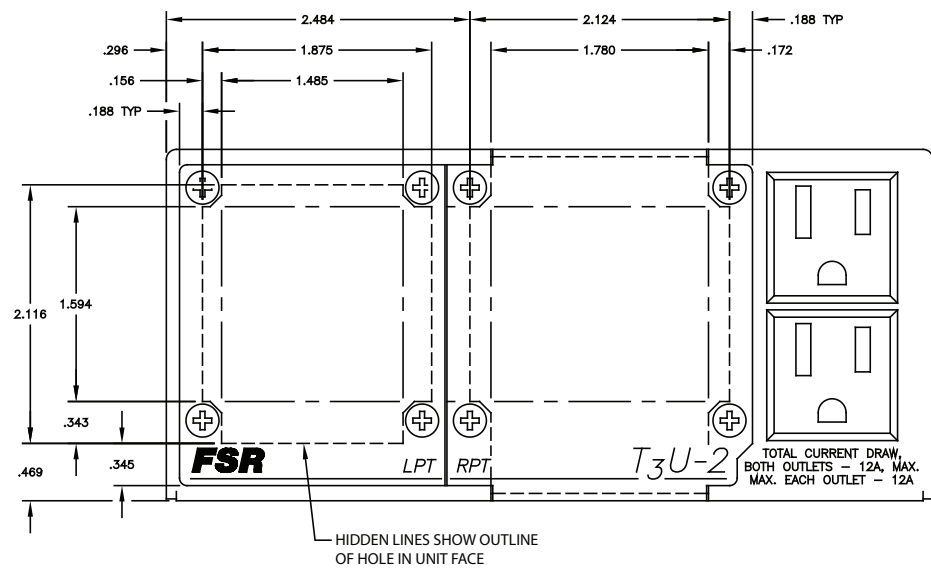

**T3U-3**

**T3U-3**  
Connector Plate View

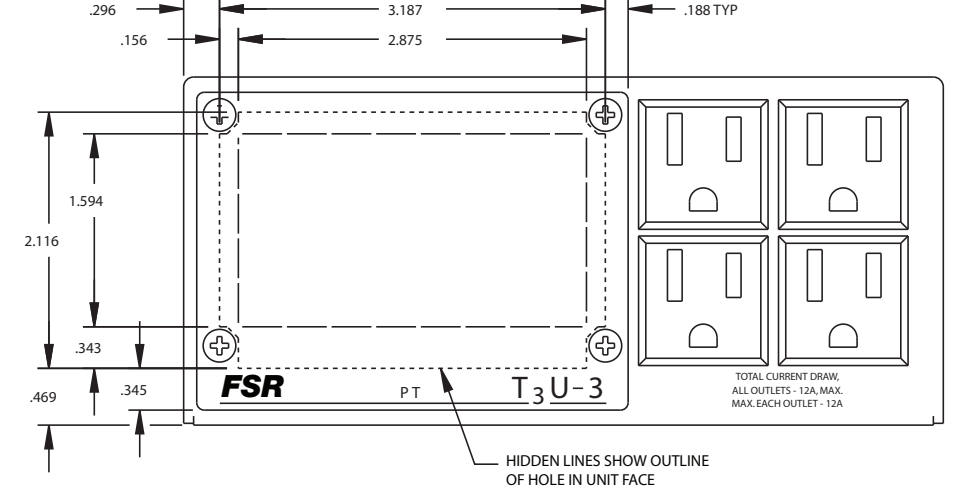
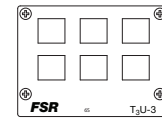
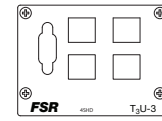
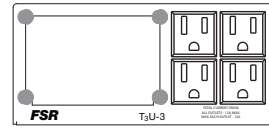

**SNAP IN CONNECTORS AVAILABLE (ALL MODELS)**

- SS-RJ45\***  
\*SS-RJ45-WHT or IVO= Punch Down  
SS-RJ45-BLK = Pass Thru
- SS-RJCAT6**  
CAT 6 to Punch Down (Black Only)
- SS-RJ11\***  
\*SS-RJ11-WHT or IVO= Punch Down  
SS-RJ11-BLK = Pass Thru
- SS-LC**  
Fiber LC Pass Thru (Black Only)
- SS-HDMI**  
HDMI Pass Thru (White and Black Only)
- SS-BNC**  
BNC Pass Thru
- SS-SCON**  
S-Video Connector Pass Thru
- SS-FCON**  
F Connector Pass Thru
- SS-RCA-R**  
Red RCA Pass Thru
- SS-RCA-B**  
Black RCA Pass Thru
- SS-RCA-Y**  
Yellow RCA Pass Thru
- SS-MINI**  
3.5mm Stereo to Solder
- SS-SWMOM**  
Momentary Switch
- SS-SWMAIN**  
Maintained Switch
- SS-CBLNK**  
Blank Insert
- SS-USBA**  
USB A Pass Thru (Black Only)
- SS-USBAHW**  
USB A to Punch Down (Black Only)
- SS-USBB**  
USB B Pass Thru (Black Only)
- SS-USBBHW**  
USB B to Punch Down (Black Only)
- SS-USB-CHRG**  
USB Universal 10W Charging Port (black only) with Power Supply

**SNAP IN CONNECTOR ORDERING DETAIL**

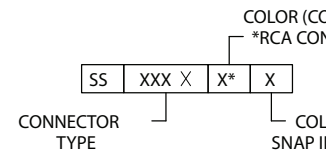

**ORDERING INFORMATION**

MODEL	FINISH	ACCEPTS (see connector plate view)
T3U-1R-BLK	BLACK	ONE T3U-1 CONNECTOR PLATE
T3U-1R-BRS	BRUSHED BRASS	ONE T3U-1 CONNECTOR PLATE
T3U-1R-NKL	BRUSHED NICKEL	ONE T3U-1 CONNECTOR PLATE
T3U-2R-BLK	BLACK	ONE SET OF T3U-2 LEFT AND RIGHT CONNECTOR PLATES
T3U-2R-BRS	BRUSHED BRASS	ONE SET OF T3U-2 LEFT AND RIGHT CONNECTOR PLATES
T3U-2R-NKL	BRUSHED NICKEL	ONE SET OF T3U-2 LEFT AND RIGHT CONNECTOR PLATES
T3U-3R-BLK	BLACK	ONE T3U-3 CONNECTOR PLATE
T3U-3R-BRS	BRUSHED BRASS	ONE T3U-3 CONNECTOR PLATE
T3U-3R-NKL	BRUSHED NICKEL	ONE T3U-3 CONNECTOR PLATE