

## RFL Series Q Raised Access Floor Boxes



RFL4.5-Q2G-BLKDD

RFL4.5-Q1G-SLCLY

RFL3-Q1G-GRY

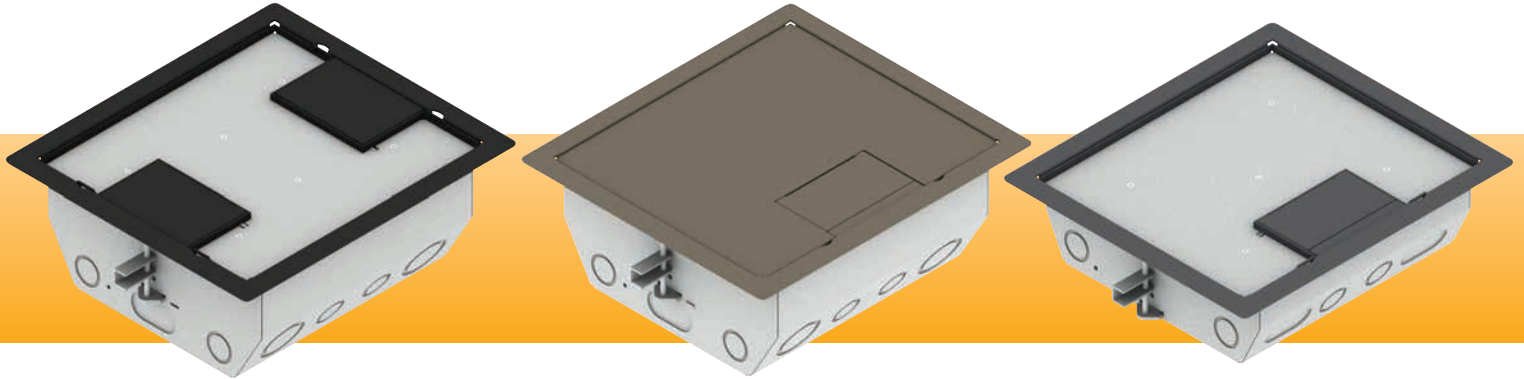

### DESCRIPTION

The RFL Series Q Raised Access Floor Boxes are designed for flexibility, durability and style. These rugged units safely handle the rigors of high traffic floor environments. There are three cover styles to choose from: Single door carpet trim cover, dual door carpet trim cover or a single door solid cover.

All cover styles are available in three colors with custom colors available on request (Consult factory).

All Series Q models feature all steel construction for durability and are designed to install in a 9 $\frac{3}{4}$ " x 11" opening in the floor. They are available in either 4 $\frac{1}{16}$ " or 3 $\frac{1}{4}$ " box depths.

The RFL4.5-Q2G is a 4 $\frac{1}{16}$ " deep floor box with four standard double gang openings, two on each side of the box. Either or both of the compartments may be used for power or data.

The RFL4.5-Q1G is a 4 $\frac{1}{16}$ " deep floor box with four standard single gang openings, two on each side of the box for power or data, and two single gang openings on the bottom for data. The data plate insert is removable for added room in the box.

The RFL3-Q1G is a 3 $\frac{1}{4}$ " deep floor box with four standard single gang openings, two on each side of the box. Either or both of the compartments may be used for power or data.

### FEATURES

The RFL Series Q features:

- Patented epoxy wrinkle powder finish, available in 3 colors
- Choice of three cover styles; solid, single-door and dual-door
- 14-gauge steel construction
- Cover thickness  $\frac{3}{16}$ "
- Oversize cable door(s)
- Standard electrical plate openings on all models
- Superior mounting clamp design to handle a wide variety of floor thicknesses
- Listed by UL to meet US and Canadian safety standards
- Large multi-compartment boxes for power, audio, video, data and more!
- Multiple knockouts in a variety of sizes
- Choice of two box depths
- Choice of three gang layout styles

*Architectural Note: The carpet rim and cable exit door are available standard in grey, black, or clay. Custom finishes are also available as an option. Optional 1" x 2" KO grommet FSR part #13342.*

### FSR Inc.

244 Bergen Boulevard, Woodland Park, NJ 07424  
Phone: 973.785.4347 · Fax: 973.785.4207  
Web: [www.fsrinc.com](http://www.fsrinc.com) · E-mail: [sales@fsrinc.com](mailto:sales@fsrinc.com)  
Order Desk: 1-800-332-FSR1

LIT1138B

# RFL-Q Cover Dimensions

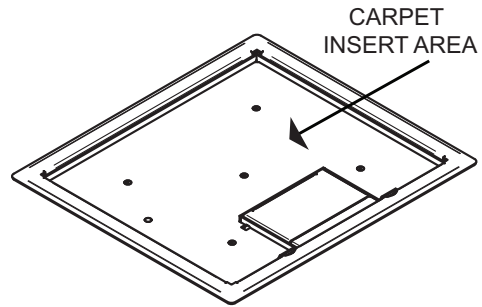
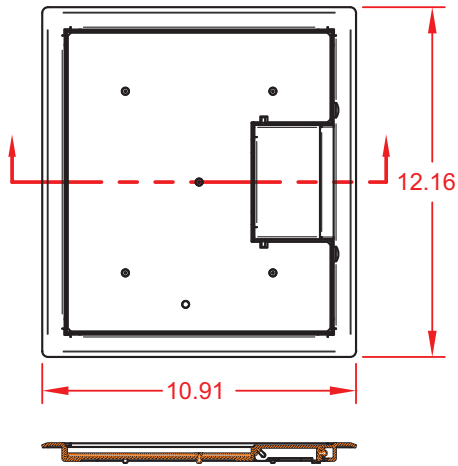

**SINGLE DOOR**

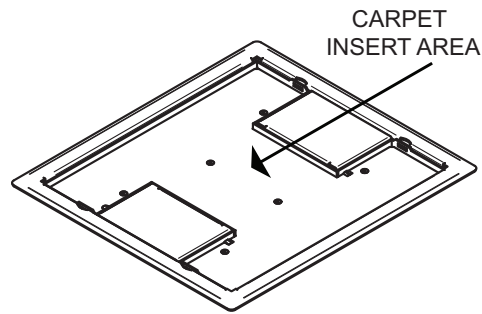
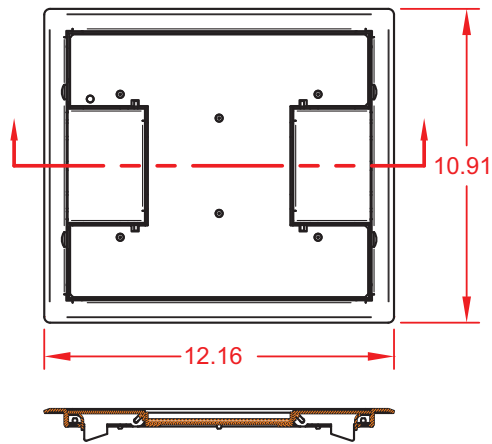

**DUAL DOOR**

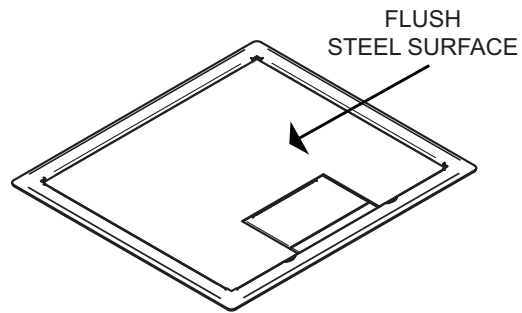
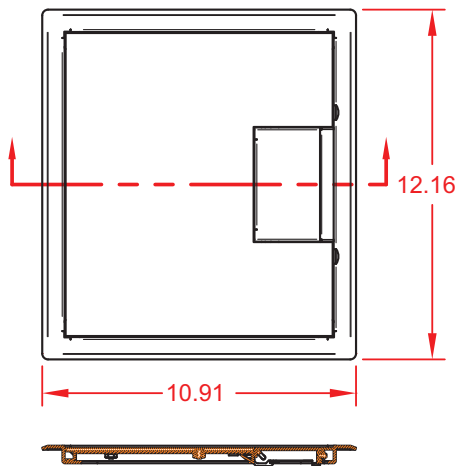

**SOLID COVER**

# RFL-Q General Dimensions

## RFL3-Q1G

9.75 x 11.00  
FLOOR HOLE SIZE

- Box Volume (Less Panels) 210 cu in
- Device Compartment Volume 46 cu in. (without divider)
- Brackets Included
  - Two, with 2 single gang openings on each side and 1 divider
- Number and Size of Knockouts
  - 4 - 1/2" on the bottom
  - 8 - 1/2" - 3/4" on the sides
  - 4 - 1" X 2" oval on the sides
- Cover Material
  - 16/14 ga Steel under 11 ga Steel Support
- Support Flange Material
  - 14 ga galvanized Steel
- Body Material
  - 14 ga galvanized Steel
- Max. No. of Device Panels
  - 2 dual single gang (Provided)

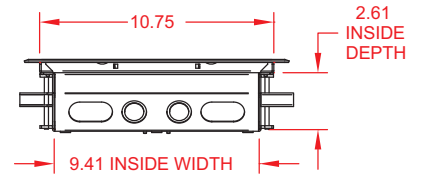
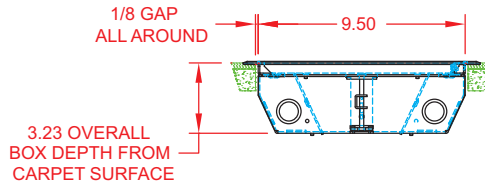
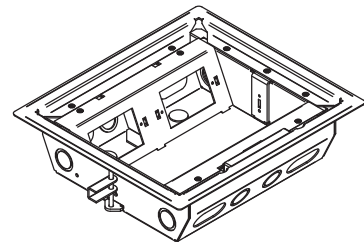
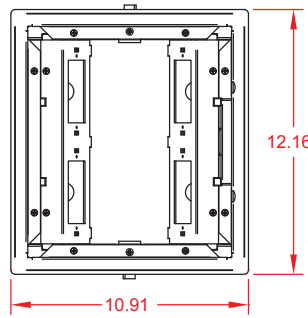

## RFL4.5-Q1G

9.75 x 11.00  
FLOOR HOLE SIZE

- Box Volume (Less Panels) 325 cu in
- Device Compartment Volume 75 cu in. (without divider)
- Brackets Included
  - Two, with 2 single gang openings on each side for power or data and one with 2 single gang openings for data on bottom
- Number and Size of Knockouts
  - 4 - 1/2" on the bottom
  - 8 - 1/2" - 3/4" on the sides
  - 4 - 1" - 1 1/4" on the sides
  - 4 - 1" X 2" oval on the sides
- Cover Material
  - 16/14 ga Steel under 11 ga Steel Support
- Support Flange Material
  - 14 ga galvanized Steel
- Body Material
  - 14 ga galvanized Steel
- Max. No. of Device Panels
  - 3 single gang (Provided)

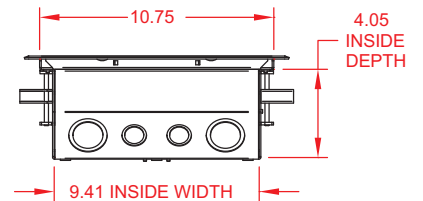
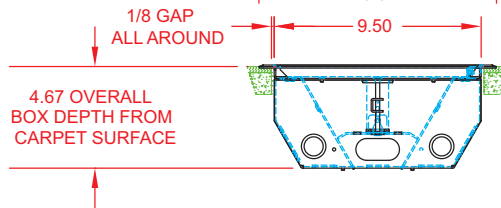
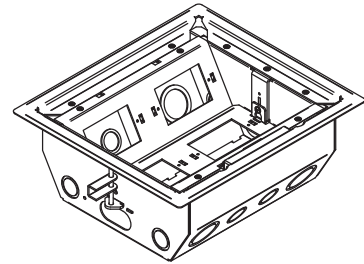
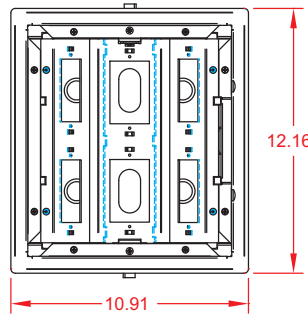

## RFL4.5-Q2G

9.75 x 11.00  
FLOOR HOLE SIZE

- Box Volume (Less Panels) 325 cu in
- Device Compartment Volume 75 cu in. (without divider)
- Brackets Included
  - Two, with 2 double gang openings on each side and 1 divider
- Number and Size of Knockouts
  - 4 - 1/2" on the bottom
  - 8 - 1/2" - 3/4" on the sides
  - 4 - 1" - 1 1/4" on the sides
  - 4 - 1" X 2" oval on the sides
- Cover Material
  - 16/14 ga Steel under 11 ga Steel Support
- Support Flange Material
  - 14 ga galvanized Steel
- Body Material
  - 14 ga galvanized Steel
- Max. No. of Device Panels
  - 2 double gang (Provided)

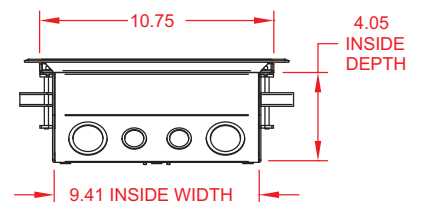
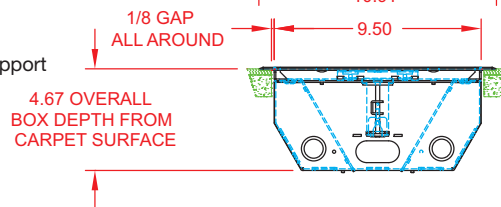
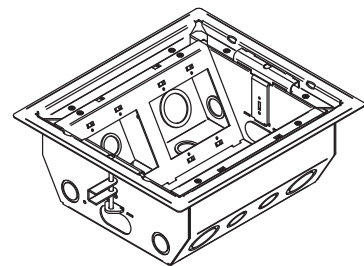
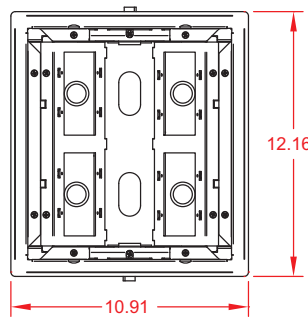

## RFL SERIES Q ORDERING INFORMATION

ITEM #	PART#	DESCRIPTION
<b>Carpet Trim Cover with Single Door 3" Deep with Four 1-Gang Openings</b>		
16101	RFL3-Q1G-GRY	3" deep back box with 4, 1-gang openings - Gray Trim
16107	RFL3-Q1G-BLK	3" deep back box with 4, 1-gang openings - Black Trim
16113	RFL3-Q1G-CLY	3" deep back box with 4, 1-gang openings - Clay Trim
<b>Carpet Trim Cover with Single Door 4.5" Deep with Six 1-Gang Openings (Two for data use only)</b>		
16104	RFL4.5-Q1G-GRY	4.5" deep back box with 6, 1-gang openings - Gray Trim
16110	RFL4.5-Q1G-BLK	4.5" deep back box with 6, 1-gang openings - Black Trim
16116	RFL4.5-Q1G-CLY	4.5" deep back box with 6, 1-gang openings - Clay Trim
<b>Carpet Trim Cover with Single Door 4.5" Deep with Four 2-Gang Openings</b>		
16105	RFL4.5-Q2G-GRY	4.5" deep back box with 4, 2-gang openings - Gray Trim
16111	RFL4.5-Q2G-BLK	4.5" deep back box with 4, 2-gang openings - Black Trim
16117	RFL4.5-Q2G-CLY	4.5" deep back box with 4, 2-gang openings - Clay Trim
<b>Carpet Trim Cover with Dual Door 3" Deep with Four 1-Gang Openings</b>		
16119	RFL3-Q1G-GRYDD	3" deep back box with 4, 1-gang openings - Gray Trim
16125	RFL3-Q1G-BLKDD	3" deep back box with 4, 1-gang openings - Black Trim
16131	RFL3-Q1G-CLYDD	3" deep back box with 4, 1-gang openings - Clay Trim
<b>Carpet Trim Cover with Dual Door 4.5" Deep with Six 1-Gang Openings (Two for data use only)</b>		
16122	RFL4.5-Q1G-GRYDD	4.5" deep back box with 6, 1-gang openings - Gray Trim
16128	RFL4.5-Q1G-BLKDD	4.5" deep back box with 6, 1-gang openings - Black Trim
16134	RFL4.5-Q1G-CLYDD	4.5" deep back box with 6, 1-gang openings - Clay Trim
<b>Carpet Trim Cover with Dual Door 4.5" Deep with Four 2-Gang Openings</b>		
16123	RFL4.5-Q2G-GRYDD	4.5" deep back box with 4, 2-gang openings - Gray Trim
16129	RFL4.5-Q2G-BLKDD	4.5" deep back box with 4, 2-gang openings - Black Trim
16135	RFL4.5-Q2G-CLYDD	4.5" deep back box with 4, 2-gang openings - Clay Trim
<b>Solid cover - Single Door 3" Deep with Four 1-Gang Openings</b>		
16137	RFL3-Q1G-SLGRY	3" deep back box with 4, 1-gang openings - Gray Trim
16143	RFL3-Q1G-SLBLK	3" deep back box with 4, 1-gang openings - Black Trim
16149	RFL3-Q1G-SLCLY	3" deep back box with 4, 1-gang openings - Clay Trim
<b>Solid cover - Single Door 4.5" Deep with Six 1-Gang Openings (Two for data use only)</b>		
16140	RFL4.5-Q1G-SLGRY	4.5" deep back box with 6, 1-gang openings - Gray Trim
16146	RFL4.5-Q1G-SLBLK	4.5" deep back box with 6, 1-gang openings - Black Trim
16152	RFL4.5-Q1G-SLCLY	4.5" deep back box with 6, 1-gang openings - Clay Trim
<b>Solid cover - Single Door 4.5" Deep with Four 2-Gang Openings</b>		
16141	RFL4.5-Q2G-SLGRY	4.5" deep back box with 4, 2-gang openings - Gray Trim
16147	RFL4.5-Q2G-SLBLK	4.5" deep back box with 4, 2-gang openings - Black Trim
16153	RFL4.5-Q2G-SLCLY	4.5" deep back box with 4, 2-gang openings - Clay Trim

### Similar FSR Products

The **RFL Series AV** raised access floor boxes are perfect for applications in raised floors where AV connections and power are required in one box. They are available in a small two gang "D" model and a larger "Q" model to accommodate up to a 4-gang arrangement (requires optional plate) to handle a variety of installation demands. See LIT1109A spec sheet for details.

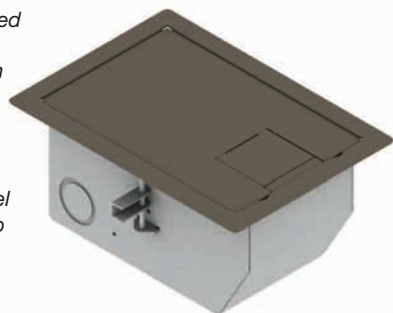

RFL-DAV-SLCLY Pictured

Specifications are subject to change without notice.

The **RFL Series D** raised access floor boxes come in two box depths and three gang layout styles. They offer compartments on opposite sides on the RFL3 and compartments on 2 sides and bottom on the RFL4.5 models. See LIT1115A spec sheet for details.



RFL3-D1G-BLK Pictured



## FSR

244 Bergen Boulevard, Woodland Park, NJ 07424  
 Phone: 973.785.4347 · Fax: 973.785.4207  
 Web: www.fsrinc.com · E-mail: sales@fsrinc.com