

Specifications

# MIRA 4-Pole MRC(AC), MRD(DC) Magnetic Contactors



Frame size

Type

Terminal type

Number of poles

Rated operation voltage, Ue

Rated insulation voltage, Ui

Rated frequency

Rated impulse withstand voltage, Uimp

Maximum operating rate in operating cycles per hour (AC3)

Durability

Mechanical

Electrical

Current and power

AC-1, Thermal current

A

200/240V

kW

A

380/440V

kW

A

500/550V

kW

A

690V

kW

A

UL rating (50/60Hz)

Continuous current

A

Single Phase

110~120V

HP

220~240V

HP

Three Phase

200~208V

HP

220~240V

HP

440~480V

HP

550~600V

HP

NEMA size

Size and weight

MRC

Weight  
Size (WxHxD)

lbs  
in

MRD

Weight  
Size (WxHxD)

lbs  
in

Auxiliary (standard)

Auxiliary

Side mount

Front mount

18AF

MRC-9A/4 MRC-12A/4 MRC-18A/4

Screw

4 pole

690V

690V

50/60Hz

6kV

1800 operations per hour

15 mil. operations

0.5 mil. operations

0.8 mil. operations

25

25

40

9

9

15

25

25

40

17

17

27

25

25

40

21

21

35

25

25

40

27

27

44

25

25

40

25

25

32

0.5

0.75

1

1.5

2

3

2

3

5

3

5

7.5

5

7.5

10

7.5

10

15

00

-

0

0.66 lbs  
45 x 73.5 x 79 in

0.99 lbs  
45 x 73.5 x 110.7 in

NONE

CA-1

CA-2, CA-4

22AF

MRC-22A/4

Screw

4 pole

690V

690V

50/60Hz

6kV

1800 operations per hour

15 mil. operations

1 mil. operations

40

15

40

27

40

35

40

44

40

32

2

3

7.5

7.5

10

15

-

0.88 lbs  
1.86 x 3.15 x 3.42 in

1.10 lbs  
1.86 x 3.15 x 4.46 in

NONE

CA-1

CA-2, CA-4



**40AF**

MRC-32A/4	MRC-40A/4
-----------	-----------

Screw

4 pole

690V

690V

50/60Hz

6kV

1800 operations per hour

15 mil. operations

1 mil. operations

50	60
----	----

18	22
50	60

35	42
50	60

43	52
50	60

55	66
50	60

45	50
----	----

2	3
---	---

5	5
---	---

7.5	10
-----	----

10	10
----	----

20	25
----	----

20	25
----	----

1	-
---	---

1.27 lbs	
2.32 x 3.29 x 3.72 in	

2.27 lbs	
2.32 x 3.29 x 4.76 in	

**NONE**

CA-1

CA-2, CA-4

**85AF**

MRC-50A/4	MRC-65A/4	MRC-75A/4	MRC-85A/4
-----------	-----------	-----------	-----------

Screw

4 pole

690V

690V

50/60Hz

8kV

1800 operations per hour

12 mil. operations

1 mil. operations

80	100	110	135
----	-----	-----	-----

30	37	41	51
80	100	110	135

56	70	76	95
80	100	110	135

70	88	97	120
80	100	110	135

88	110	120	150
80	100	110	135

70	80	90	100
----	----	----	-----

3	5	5	7.5
---	---	---	-----

7.5	10	15	15
-----	----	----	----

10	15	20	25
----	----	----	----

15	20	25	30
----	----	----	----

30	40	50	50
----	----	----	----

30	40	50	50
----	----	----	----

2	-	-	3
---	---	---	---

3.66 lbs	
3.58 x 4.86 x 4.64 in	

4.66 lbs	
3.58 x 4.86 x 4.64 in	

**NONE**

CA-1

CA-2, CA-4

Specifications

# MIRA 4-Pole MRC (AC/DC) Magnetic Contactors



Frame size

Type	
Terminal type	
Number of poles	
Rated operation voltage, Ue	
Rated insulation voltage, Ui	
Rated frequency	
Rated impulse withstand voltage, Uimp	
Maximum operating rate in operating cycles per hour (AC3)	

Durability	Mechanical	
	Electrical	
Current and power	AC-1, Thermal current	A
	AC-3	200/240V kW A
		380/440V kW A
		500/550V kW A
		690V kW A
UL rating (50/60Hz)	Continuous current	A
UL rating (50/60Hz)	Single Phase	110~120V HP
		220~240V HP
	Three Phase	200~208V HP
		220~240V HP
		440~480V HP
		550~600V HP
NEMA size		

Size and weight	Weight Size (WxHxD)	lbs in
-----------------	---------------------	--------

Auxiliary (standard)

Auxiliary	Side mount
-----------	------------

\* FLA = 722 A, LRA = 5618 A  
\*\* FLA = 566 A, LRA = 4495 A

225AF

MRC-100A/4	MRC-130A/4	MRC-150A/4	MRC-185A/4	MRC-225A/4
Screw				
4 pole				
690V				
1000V				
50/60Hz				
8kV				
1200 operations per hour				
5 mil. operations				
0.8 mil. operations				
160	165	250	300	330
57	60	76	87	100
150	155	200	230	260
106	110	142	165	185
150	155	200	230	260
132	137	180	203	230
150	155	200	230	260
165	170	225	255	290
150	155	200	230	260
160	160	210	230	275
7.5	10	15	15	15
15	20	25	30	40
30	40	40	60	60
30	40	50	60	75
60	75	100	125	150
60	75	100	125	150
-	-	4	-	-

12.35 lbs 6.89 x 7.99 x 7.28 in
------------------------------------

2NO & 2NC

CA-100
--------



400AF	
MRC-330A/4	MRC-400A/4
Screw	
4 pole	
690V	
1000V	
50/60Hz	
8kV	
1200 operations per hour	
2.5 mil. operations	
0.5 mil. operations	
420	500
135	160
350	420
250	300
350	420
315	375
350	420
390	470
350	420
350	450
-	-
-	-
100	125
125	125
250	300
250	300
5	-
21.83 lbs 8.11 x 9.57 x 8.07 in	
2NO & 2NC	
CA-100	

800AF	
MRC-630A/4	MRC-800A/4
Screw	
4 pole	
690V	
1000V	
50/60Hz	
8kV	
1200 operations per hour	
2.5 mil. operations	
0.5 mil. operations	
750	900
255	310
660	800
470	570
660	800
590	710
660	800
740	900
660	800
660	900
-	-
-	-
200	200
250	300
500	600*
500	600**
6	7
57.98 lbs 13.62 x 12.20 x 9.61 in	
2NO & 2NC	
CA-100	

## Ordering Information

### MIRA MRC Series 9-85A AC 4 Pole Contactor Ratings

Frame Size	Model Number	AC 3 Rating @ 440V	NEMA Size	Continuous Current (A)	UL MAX HP RATING (50/60Hz)					
					Single Phase		Three Phase			
					110~120V	220~240V	200~208V	220~240V	440~480V	550~600V
18AF	MRC-9A/4	25A	00	25	0.5	1.5	2	3	5	7.5
	MRC-12A/4	25A	-	25	0.75	2	3	5	7.5	10
	MRC-18A/4	40A	0	32	1	3	5	7.5	10	15
22AF	MRC-22A/4	40A	-	32	2	3	7.5	7.5	10	15
40AF	MRC-32A/4	50A	1	45	2	5	7.5	10	20	20
	MRC-40A/4	60A	-	50	3	5	10	10	25	25
85AF	MRC-50A/4	80A	2	70	3	7.5	10	15	30	30
	MRC-65A/4	100A	-	80	5	10	15	20	40	40
	MRC-75A/4	110A	-	90	5	15	20	25	50	50
	MRC-85A/4	135A	3	100	7.5	15	25	30	50	50

#### Coil Voltage (18~85AF)

AC	50/60 Hz	24, 48, 120, 220, 240, 380V
	60 Hz	208, 277, 380, 480, 600V

## How to Order:

# (Model Number)-(Coil Voltage)

### Example:

**MRC-9A/4-24VAC**

MODEL NUMBER      COIL VOLTAGE (VAC/VDC)

## Ordering Information

### MIRA MRC Series 100-800A AC 4 Pole Contactor Ratings

Frame Size	Model Number	AC 3 Rating @ 440V	NEMA Size	Continuous Current (A)	UL MAX HP RATING (50/60Hz)					
					Single Phase		Three Phase			
					110~120V	220~240V	200~208V	220~240V	440~480V	550~600V
225AF	MRC-100A/4	150A	-	160	7.5	15	30	30	60	60
	MRC-130A/4	155A	-	160	10	20	40	40	75	75
	MRC-150A/4	200A	4	210	15	25	40	50	100	100
	MRC-185A/4	230A	-	230	15	30	60	60	125	125
	MRC-225A/4	260A	-	275	15	40	60	75	150	150
400AF	MRC-330A/4	350A	5	350	-	-	100	125	250	250
	MRC-400A/4	420A	-	450	-	-	125	125	300	300
800AF	MRC-630A/4	660A	6	660	-	-	200	250	500	500
	MRC-800A/4	800A	7	900	-	-	200	300	600	600

Coil Voltage (225AF)		
AC/DC	AC 50/60 Hz	24, 48, 100~240V
	DC	
AC	AC 50/60 Hz	300VAC (265~347V)
		400VAC (380~450V)
		500VAC (440~575V)

Coil Voltage (800AF)		
AC/DC	AC 50/60 Hz	100VAC (100~240V)
	DC	200VAC (200~240V)
AC	AC 50/60 Hz	300VAC (265~347V)
		400VAC (380~450V)
		500VAC (440~575V)

Coil Voltage (400AF)		
AC/DC	AC 50/60 Hz	100~240V
	DC	
AC	AC 50/60 Hz	300VAC (265~347V)
		400VAC (380~450V)
		500VAC (440~575V)

## How to Order:

# (Model Number)-(Coil Voltage)

Example:

**MRC-225A/4-300VAC**

MODEL NUMBER      COIL VOLTAGE (VAC/VDC)

4-Pole Contactors (MRC-18AF~22AF)

[in]

MRC-9A/4~18A/4

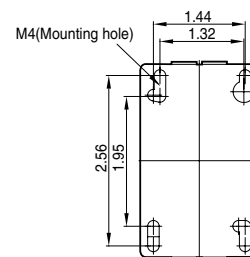
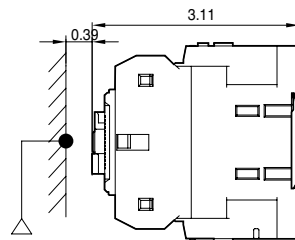
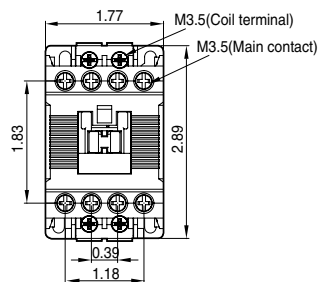

0.66lbs

MRD-6A/4~18A/4

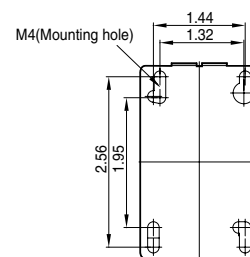
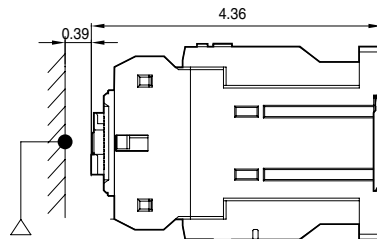
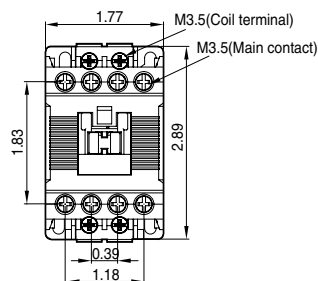

0.99lbs

MRC-22A/4

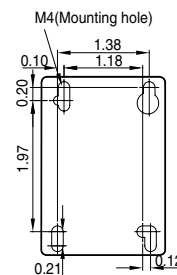
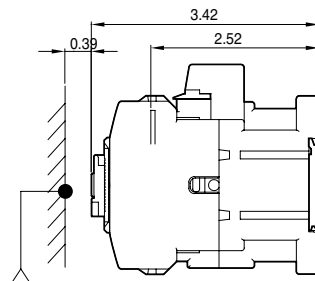
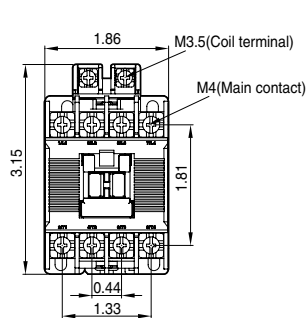

0.88lbs

MRD-22A/4

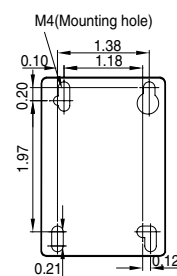
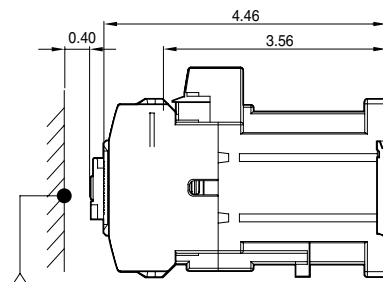
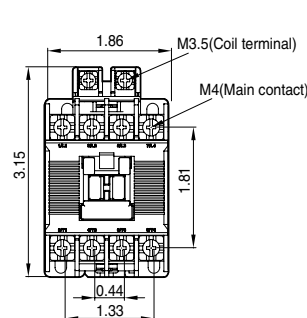

1.10lbs

4-Pole Contactors (MRC-40AF~85AF)

MRC-32A/4~40A/4

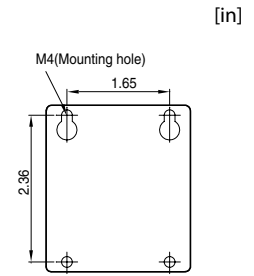
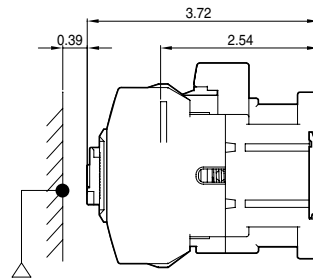
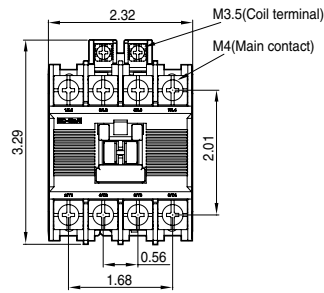

1.27lbs

MRD-32A/4~40A/4

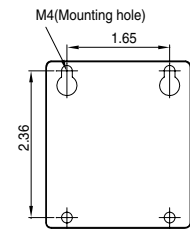
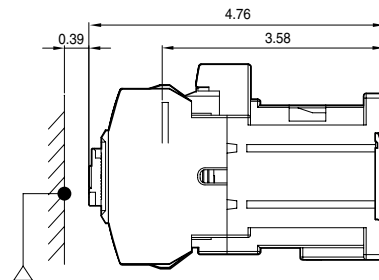
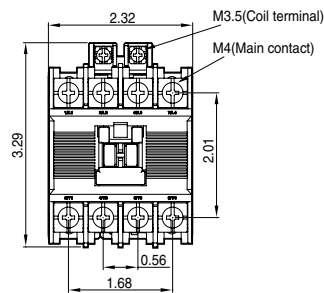

2.27lbs

MRC-50A/4~85A/4

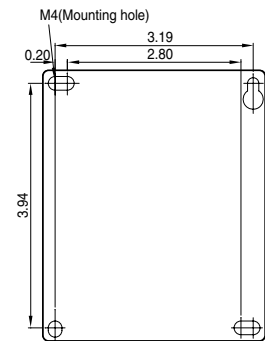
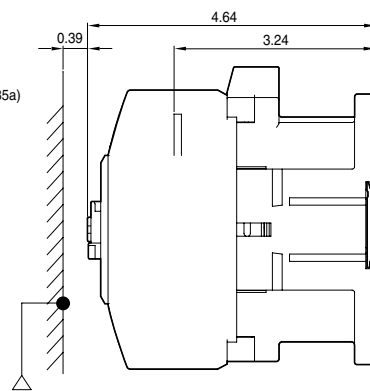
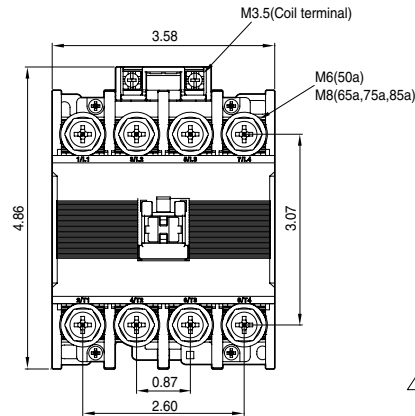

3.66lbs

MRD-50A/4~85A/4

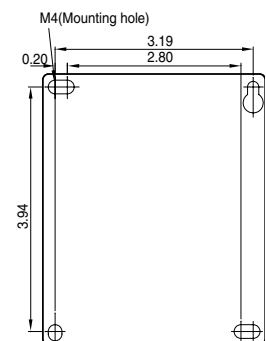
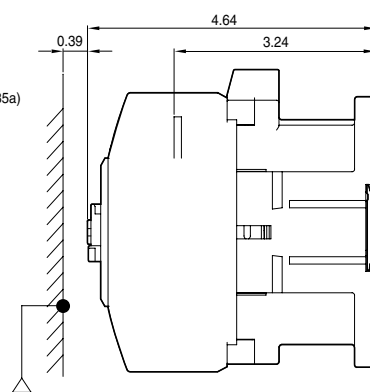
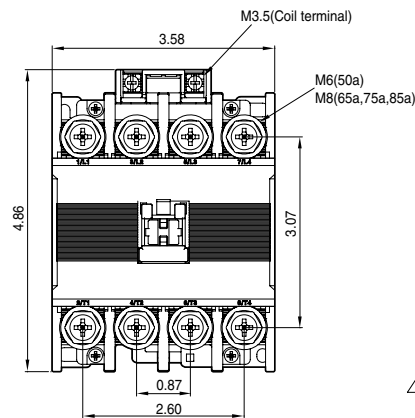

4.66lbs



4-Pole Contactors (MRC-225AF~800AF)

[in]

- MRC-100A/4
- MRC-130A/4
- MRC-150A/4
- MRC-185A/4
- MRC-225A/4

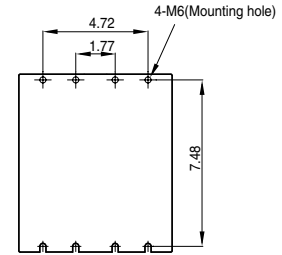
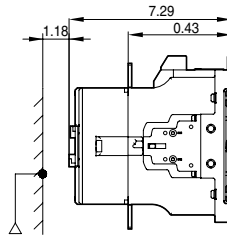
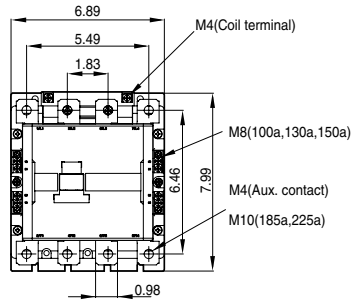

12.35lbs

- MRC-265A/4
- MRC-330A/4
- MRC-400A/4

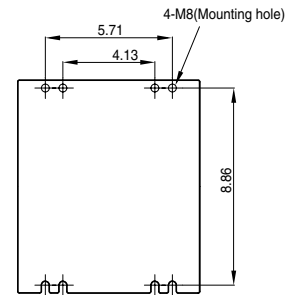
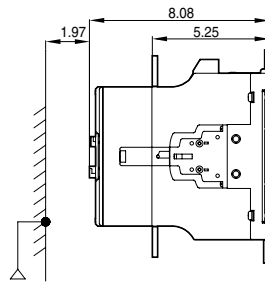
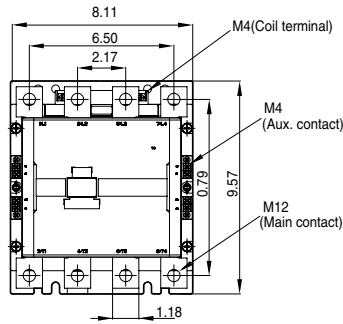

21.83lbs

- MRC-500A/4
- MRC-630A/4
- MRC-800A/4

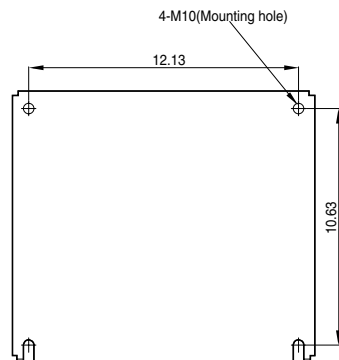
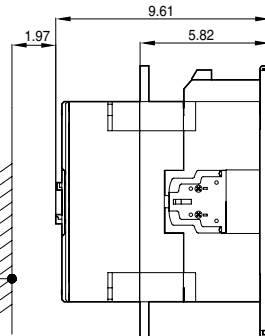
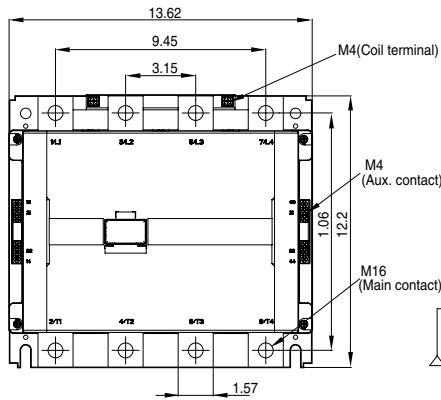

57.98lbs