

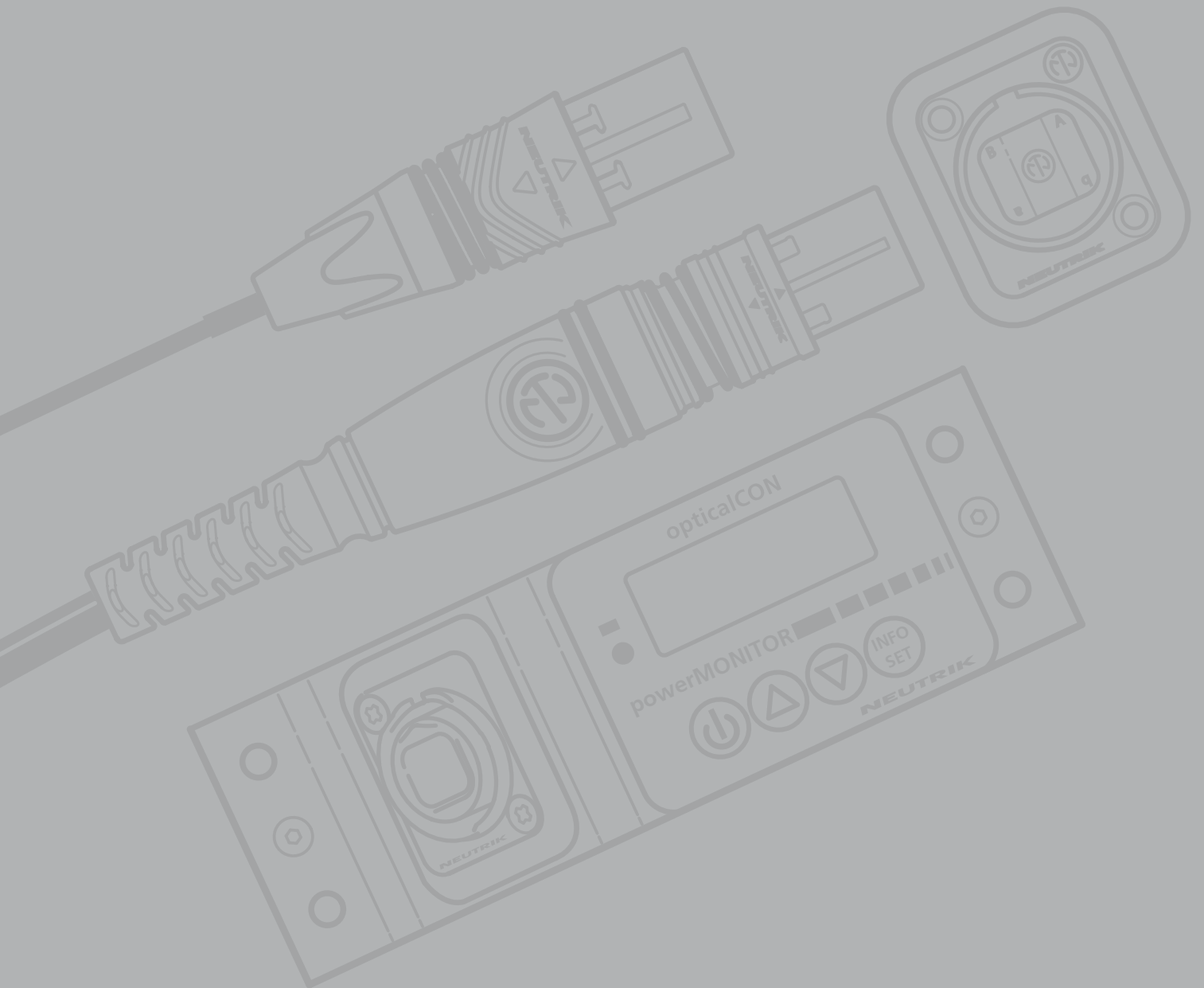

opticalCON



NEUTRIK®

Content

PAGE

Introduction	4
Design Criteria	5
Features & Benefits - opticalCON ADVANCED	6
Features & Benefits - opticalCON LITE	8
opticalCON Cables	10
opticalCON DUO	12
Cable Connector Assembly	12
Chassis Connector	12
Hybrid DUO Cable	13
Technical Data Cables	13
opticalCON QUAD	14
Cable Connector Assembly	14
Chassis Connector	14
Technical Data Cables	15
opticalCON MTP®	16
Cable Connector Assembly	16
Chassis Connector	16
MTP® Connector	17
Technical Data Cables	17
opticalCON SPLIT Cables	18
SPLIT Cable & POWER SPLIT Cable	18
Technical Data Cables	18
opticalCON LITE	19
Cable Connector Assembly DUO LITE	19
Cable Connector Assembly QUAD LITE	20
Cable Connector Assembly MTP® LITE	21
Technical Data Cables	21
Technical Data opticalCON Connectors	22
Cable & Chassis Connectors	22



Ordering Information	24
Mobile Cables	26
Chassis Connectors	28
Coupler	28
Breakout Adapter	28
Transceiver Adapter	29
Accessories	29
Pulling Solutions	29
Fiber Optic Measurement & Cleaning Kit	30
opticalCON Connector Field Assembly	31
opticalCON powerMONITOR	32
powerMONITOR	32
1RU & 3RU 19" Rack Units	32
Breakout Box	32
Ordering Information	33
Breakout & Panel Solutions	34
Breakout Box	34
19" Z-Panels & Plates	34
Ordering Information D-Shape Z-Panel	35
Ordering Information Breakout Box & Power Supply	36
Applications	37
Audio Application	38
Video/Lighting Application	39
Broadcast Application OB Truck	40
Broadcast Application SNG/ENG	42
Broadcast Application Studio Routing	43
Wiring And Hook Up Suggestion	44
opticalCON DUO or QUAD?	44
Cable Wiring	45

www.neutrik.com – opticalCON



The Applications for Fiber are Extensive

A few years ago, the use of fiber optic cabling in professional AV applications was limited to such special cases as HD broadcast cameras. Since then, the AV industry's adoption of fiber optics has increased immensely. Today, fiber optics are widely used for digital signal transmission in pro audio, professional broadcast, and the touring / rental industries.

As pro audio and broadcast equipment has evolved from analog to digital data transmission, the industry has attempted to adapt connectors originally designed for data communication (e.g. RJ45 connectors for electrical transmission). Today, that trend continues with fiber optic connectors. However, conventional data communication fiber optic connectors (ST, SC, LC, etc.) have a risk of failure when they are deployed in AV applications. These conventional data connectors are optimized for permanent, one-time connection. They were never designed for mobile applications or to handle high mating cycles in harsh

environments. Alternative connectors, originally developed for military applications, have not been cost effective and have been deficient either in regards to dust protection and maintenance and/or in their attenuation and return loss characteristics.

Neutrik understood these deficiencies and solved the various issues associated with mobile fiber optic connectivity when it launched its opticalCON fiber optic line in 2005. The opticalCON design is based on a unique concept which combines low maintenance, high mating cycles, and a safe connection in the field. As a result, opticalCON has gained wide acceptance in the pro audio and professional broadcast industries. Both well-known equipment manufacturers and key industry users have put their trust in opticalCON for many years.



opticalCON Design Criteria



SMPTE standard ST2091 pending

The need for rugged fiber optic connections continues to grow rapidly, driven by such technologies as ultra high definition (UHD) 4K or 8K television signals running at data rates of up to 24 Gb/s. To accommodate these higher bandwidth signals, the Society of Motion Picture & Television Engineers (SMPTE) has standardized opticalCON connectors as the fiber optic interface for mobile high-definition television broadcasting where robust and reliable solutions are required. Neutrik's opticalCON system became the fiber optic standard in various markets.

opticalCON ADVANCED DUO is an LC-based fiber optic connection system which is typically used for equipment connections. With built-in, automatic dust shutters and a rugged housing, the fibers are always dust protected, and high mating cycles in harsh environments are achieved. Compatibility with conventional LC connectors at both the front and the rear of the chassis connectors offers users the choice of using either cost-effective, standard LC patch cables or else ruggedized opticalCON cables.

Following on the success of opticalCON ADVANCED DUO, the **opticalCON ADVANCED QUAD** series, also an LC-based connector system, doubles the fiber count to offer a rugged point-to-point connection. opticalCON QUAD has been successfully deployed in applications such as data routing for touring / live rental, including especially OB (outdoor broadcast) applications.

opticalCON ADVANCED MTP® increases the number of fibers in one connector to 12 and is the ideal solution for point-to-point multi-fiber signal transmission.

As an alternative to opticalCON MTP's single 12-fiber connector, Neutrik offers a wide variety of SPLIT cables. These 6-12 fiber solutions terminate in either two or three opticalCON DUO and/or QUAD connectors. opticalCON SPLIT offers an alternative for users of opticalCON DUO or QUAD chassis connectors, providing advantages in regards to field assembly and potential repair cost.

Finally, Neutrik's brand new **opticalCON LITE** connectors offer a cost effective and lightweight solution. The unique design of opticalCON LITE's tactical patch cable allows extreme bending without fiber breakage and absorbs high lateral forces. As a result, opticalCON LITE is an ideal choice for such permanent and semi-permanent installations as server rooms, patch fields, and indoor cabling.

fiberopticsystems

opticalCON ADVANCED Features & Benefits

- MOBILE USE
- RUGGED
- LOW MAINTENANCE
- SIMPLE INTEGRATION

UHD 4K8K

Lockable, O-ring sealed
metal protection cap

Custom color coding

Protective rubber coating

Ratched lock bushing

Ergonomic anti-kink boot
for various cable O.D.s



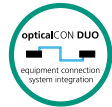

opticalCON DUO ADVANCED

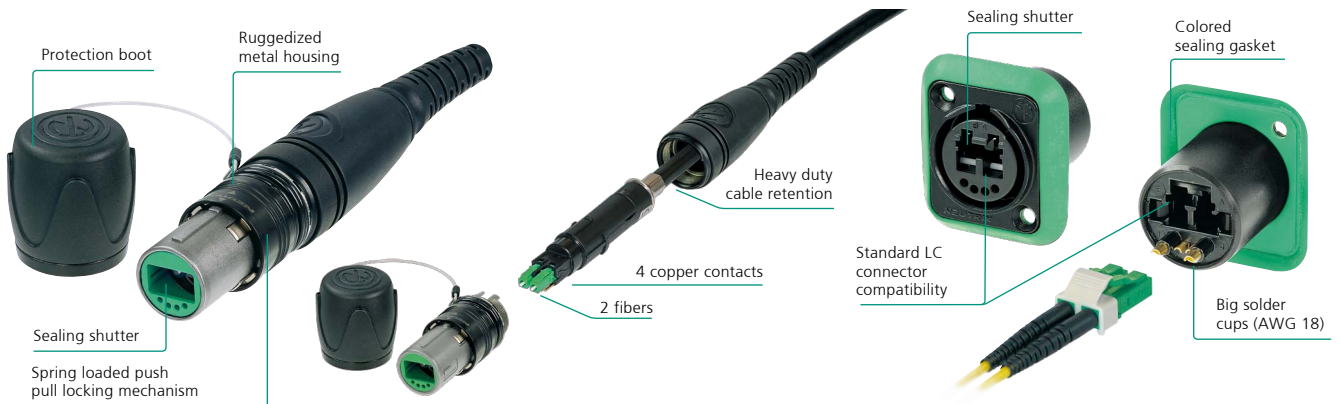

opticalCON QUAD ADVANCED



opticalCON MTP® ADVANCED



opticalCON LITE

Features & Benefits

- SMALL FORM FACTOR
- TACTICAL PATCH CABLE
- SAFE CONNECTION
- COST EFFECTIVE

UHD 4K8K

Compatible with
opticalCON DUO chassis

Custom color coding

Rubber protection cap

Cost effective rugged housing

Robust lightweight fiber

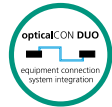

opticalCON DUO LITE



opticalCON QUAD LITE

NEW



opticalCON MTP® LITE

NEW

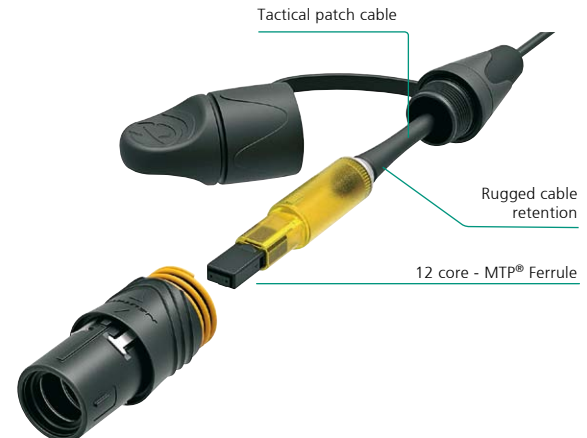

opticalCON Cables

opticalCON DUO ADVANCED

2M / 2S (A)



opticalCON DUO

Rugged and lightweight 2 channel mobile field cable, excellent cable retention due to aramid yarn, black PUR outer jacket, available in multi- and single mode (PC or APC), military approved.

XM / X2S (A)



opticalCON DUO X-TREME

2 channel X-TREME cable offering a cut-proof and rodent resistant double jacket glass yarn armoured cable construction, excellent cable retention due to aramid yarn, black PUR outer jacket.

XX2M / XX2S (A)



opticalCON DUO ARMORED

Extra rugged and lightweight stainless steel, jacket absorbs lateral forces up to 200 kg/cm². Ultra flexible due to the special spring shape construction, available in multi- and single mode (PC or APC).

H1



opticalCON DUO HYBRID

Extra rugged hybrid cable with 2 multimode channels and 4 x 0.75mm² copper conductors, GFK strength member and aramid yarn as cable retention.

S1



opticalCON DUO SMPTE

SMPTE cable with 2 single mode channels (PC or APC), 2 x AWG 24 and 4 x AWG 20 stranded copper conductors, overall copperbraided shield and stainless steel strength member, 120 kg/km.

S5



opticalCON DUO LOW VOLTAGE HYBRID

Ultra flexible, cost effective and lightweight (65 kg/km) low voltage camera / SM hybrid cable with 2 single mode channels and 2 x AWG 16 copper conductors, aramid yarn cable retention.

opticalCON QUAD ADVANCED

4M / 4S (A)



opticalCON QUAD

Rugged and lightweight 4 channel mobile field cable, excellent cable retention due to aramid yarn, black PUR outer jacket, available in multi- and single mode (PC or APC).

X4M / X4S (A)

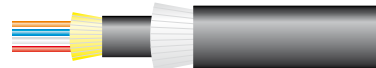

opticalCON QUAD X-TREME

4 channel X-TREME cable offering a cut-proof and rodent resistant double jacket glass yarn armoured cable construction, excellent cable retention due to aramid yarn, black PUR outer jacket.

XX4M / XX4S (A)



opticalCON QUAD ARMORED

Extra rugged and lightweight stainless steel jacket absorbs lateral forces of 200kg/cm². Ultra flexible due to the special spring shape construction, available in multi- and single mode (PC or APC).

opticalCON MTP® & SPLIT ADVANCED

12M / 12S (A)



opticalCON MTP® & SPLIT

Rugged and lightweight 12 channel mobile field cable, excellent cable retention due to aramid yarn, black PUR outer jacket, available in multi- and single mode (PC or APC).

X12M / X12S (A)

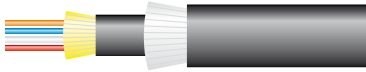

opticalCON MTP® X-TREME & SPLIT

12 channel X-TREME cable offering a cut-proof and rodent resistant double jacket glass yarn armoured cable construction, excellent cable retention due to aramid yarn, black PUR outer jacket.

opticalCON POWER-SPLIT ADVANCED

P8M / P8S (A)

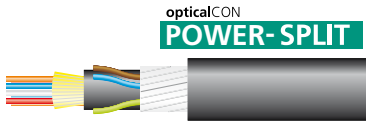

opticalCON POWER-SPLIT

Extra rugged hybrid cable up to 8 single mode channels and 2 x 1.5 mm² copper conductors, 1.5 mm² shield, 2 opticalCON cable connectors and 1 powerCON cable connector.

opticalCON DUO LITE

2M-L / 2S (A)-L



opticalCON DUO LITE

Rugged and lightweight 2 channel patch cable, excellent cable retention due to aramid yarn, black PUR outer jacket, available in multi- and single mode (PC or APC), suitable for permanent and temporary installation.

opticalCON QUAD LITE

4M-L / 4S (A)-L



opticalCON QUAD LITE

Lightweight tactical patch cable, 4 x 900/125 micron fibers, rugged cable retention due to aramid yarn, black PUR outer jacket, available in multi- and single-mode (PC or APC), designed for permanent or semi-permanent installations.

opticalCON MTP® LITE

12M-L / 12S (A)-L



opticalCON MTP® LITE

Rugged tactical patch cable, 12x 250/125 micron fibers, aramid yarn for appropriate cable retention, black PUR outer jacket, available in multi- and single-mode (PC or APC), suitable for permanent or semi-permanent installations.

opticalCON DUO ADVANCED

Cable Connector Assembly



NKO2S-A*

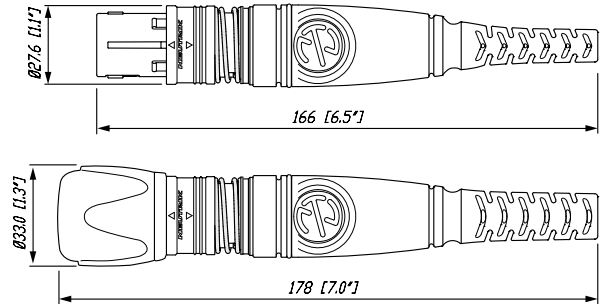

- Ruggedized and dirt-protected 2-channel fiber optic connection system
- Cable connector features rugged all-metal housing and heavy-duty cable retention
- Automatic sealing shutter with silicone gasket
- Dust and water resistant according to IP65 in mated condition
- Accommodates standard optical LC-Duplex connectors
- Field repairable
- Easy to clean, no tools required
- Reliable Push-Pull locking mechanism
- Color-coded cable connector comes pre-assembled with a choice of mobile field cables

Chassis Connector



NO2-4FDW-A with SCDP-0



NAO2*-SFP-LC

opticalCON DUO Chassis with transceiver adapter and SFP transceiver

- Ruggedized and dirt-protected 2-channel fiber optic connection system
- Shutter with silicon gasket protects optical connection from dust and dirt
- Suggested OEM equipment connectors due to LC front compatibility
- Accommodates standard LC connectors on the rear for simple installation
- Dust and water resistant according to IP65 in mated condition
- Connection on the front side either by rugged opticalCON or standard LC connector
- Color-coded rubber sealing gasket SCDP-* (black, blue, green to identify fiber mode)

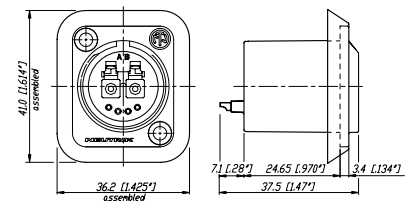

Hybrid DUO Cables



NKO2S-S5-A*

- Range of 3 hybrid cables for powered applications:
 - SMPTE cable for indoor HD camera routing applications¹
 - Hybrid multimode cable
 - Low voltage camera / SM hybrid cable for ENG/SNG applications

¹... Not compatible to SMPTE 304M standard. Suitable for indoor (studio) camera links considering specific conditions acc. to IEC 60664-1 like pollution degree 1, overvoltage category 1 and rated voltage. For detailed information ask for the White Paper "opticalCON @ SMPTE Indoor Applications".

Technical Data Cables

	Max. numbers of fibers	MODE		FIBER	Bend optimized fiber	Laser optimized fiber	Copper wires				Outer shield			Strength member		Cable retention		Overall diameter (mm)	Jacket	Optical connector	Min. bending radius (cm)	Weight (kg / km)	Attenuation (dB / km)	Bandwidth (MHz-km)	Refraction index	Power solution	
		Multimode PC	Single mode PC / APC				50 / 125-OMB	9 / 125-6657A	AWG 16	AWG 18 (0.75 mm ²)	AWG 20	AWG 24	Copperbraid	Coated glass yarn	Stainless steel Jacket	GFK	Stainless Steel										Aramid yarn
2M	2	•	-	•	•	•	-	-	-	-	-	-	-	-	-	•	-	5.0	•	•	-	5	21	@ 850 nm - 3.5 @ 1300 nm - 1.5	@ 850 nm > 1500 @ 1300 nm > 500	@ 850 nm - 1.483 @ 1300 nm - 1.479	-
2S (A)	2	-	•	-	•	N/A	-	-	-	-	-	-	-	-	-	•	-	5.0	•	•	-	5	23	@ 1310 nm - 0.5 @ 1550 nm - 0.5		@ 1310 nm - 1.458 @ 1550 nm - 1.458	-
2M-H1	2	•	-	•	-	-	-	4x	-	-	-	-	-	•	-	•	-	8.9	•	•	-	8.9	78	@ 850 nm - 2.5 @ 1300 nm - 0.7	@ 850 nm - 500 @ 1300 nm - 500	@ 850 nm - 1.482 @ 1300 nm - 1.477	-
2S (A) - S1	2	-	•	-	•	N/A	-	-	4x	2x	•	-	-	-	•	-	•	9.2	•	•	-	10	120	@ 1310 nm - 0.45 @ 1550 nm - 0.5		@ 1310 nm - 1.468 @ 1550 nm - 1.468	-
2S (A) - S5	2	-	•	-	•	N/A	2x	-	-	-	-	-	-	-	-	•	-	7.5	•	•	-	7.5	65	@ 1310 nm - 0.5 @ 1550 nm - 0.5		@ 1310 nm - 1.458 @ 1550 nm - 1.458	-
X2M	2	•	-	•	-	•	-	-	-	-	-	-	-	-	-	•	-	9.2	•	•	-	9.2	79	@ 850 nm - 2.5 @ 1300 nm - 0.5	@ 850 nm ≥ 1500 @ 1300 nm ≥ 500	@ 850 nm - 1.482 @ 1300 nm - 1.477	-
X2S (A)	2	-	•	-	•	N/A	-	-	-	-	-	-	-	-	-	•	-	9.2	•	•	-	9.2	79	@ 1310 nm - 0.35 @ 1550 nm - 0.21		@ 1310 nm - 1.467 @ 1550 nm - 1.467	-
XX2M	2	•	-	•	-	•	-	-	-	-	-	-	-	-	-	•	-	10.5	•	•	-	10.5	131	@ 850 nm - 3.5 @ 1300 nm - 1.5	@ 850 nm ≥ 1500 @ 1300 nm ≥ 500	@ 850 nm - 1.483 @ 1300 nm - 1.479	-
XX2S (A)	2	-	•	-	•	N/A	-	-	-	-	-	-	-	-	-	•	-	10.5	•	•	-	10.5	133	@ 1310 nm - 0.5 @ 1550 nm - 0.5		@ 1310 nm - 1.458 @ 1550 nm - 1.458	-

opticalCON QUAD ADVANCED Cable Connector Assembly

UHD 4K8K

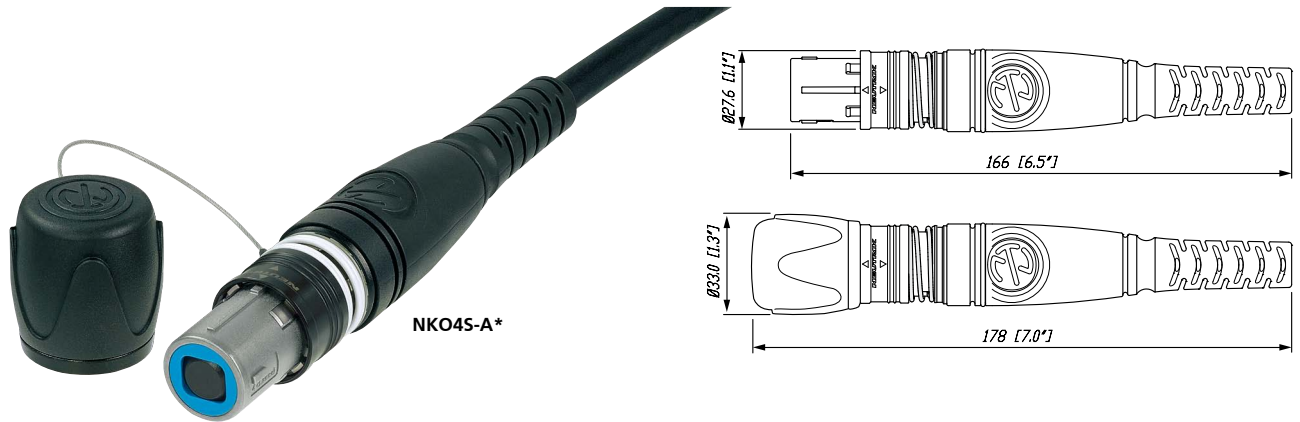

- Ruggedized and dirt-protected 4-channel fiber optic connection system
- For POINT-TO-POINT multichannel routing
- Cable connector features rugged all-metal housing and heavy-duty cable retention
- Innovative spherical shutter guarantees low maintenance
- Dust and water resistant according to IP65 in mated condition
- Easy to clean, no tools required
- Reliable Push-Pull locking mechanism
- Color-coded cable connector comes pre-assembled with a choice of mobile field cables
- Field repairable

Chassis Connector



NO4FDW-A with SCDP-0

- Ruggedized and dirt-protected 4-channel fiber optic connection system
- For POINT-TO-POINT multichannel routing
- Laser protective metal shutter seals dust proof with two-component rubber gasket
- Dust and water resistant according to IP65 in mated condition
- Accommodates standard LC connectors on the rear for simple installation
- Color-coded rubber sealing gasket (black, blue, green to identify fiber mode)

Technical Data Cables

	Max. numbers of fibers	MODE		FIBER	Bend optimized fiber	Laser optimized fiber	Copper wires				Outer shield			Strength member		Cable retention		Overall diameter (mm)	Jacket	Optical connector		Min. bending radius (cm)	Weight (kg / km)	Attenuation (dB / km)	Bandwidth (MHz-km)	Refraction index	Power solution
		Multimode PC	Single mode PC / APC				50 / 125-OMB	9 / 125-G657A	AWG 16	AWG 18 (0.75 mm ²)	AWG 20	AWG 24	Copperbraid	Coated glass yarn	Stainless steel Jacket	GFK	Stainless Steel			Aramid yarn	Crimp type						
4M	4	•	-	•	-	•	•	-	-	-	-	-	-	-	-	•	-	5.8	•	-	•	5.8	31	@ 850 nm - 2.5 @ 1300 nm - 0.5	@ 850 nm ≥ 1500 @ 1300 nm ≥ 500	@ 850 nm - 1.482 @ 1300 nm - 1.477	-
4S (A)	4	-	•	-	•	N/A	-	-	-	-	-	-	-	-	•	-	5.8	•	-	•	5.8	31	@ 1310 nm - 0.35 @ 1550 nm - 0.21		@ 1310 nm - 1.467 @ 1550 nm - 1.467	-	
X4M	4	•	-	•	-	•	•	-	-	-	-	-	•	-	-	•	-	9.2	•	-	•	9.2	79	@ 850 nm - 2.5 @ 1300 nm - 0.5	@ 850 nm ≥ 1500 @ 1300 nm ≥ 500	@ 850 nm - 1.482 @ 1300 nm - 1.477	-
X4S (A)	4	-	•	-	•	N/A	-	-	-	-	-	-	•	-	-	•	-	9.2	•	-	•	9.2	79	@ 1310 nm - 0.35 @ 1550 nm - 0.21		@ 1310 nm - 1.467 @ 1550 nm - 1.467	-
XX4M	4	•	-	•	-	•	•	-	-	-	-	-	•	-	-	•	-	10.5	•	-	•	10.5	141	@ 850 nm - 2.5 @ 1300 nm - 0.5	@ 850 nm ≥ 1500 @ 1300 nm ≥ 500	@ 850 nm - 1.482 @ 1300 nm - 1.477	-
XX4S (A)	4	-	•	-	•	N/A	-	-	-	-	-	-	•	-	-	•	-	10.5	•	-	•	10.5	141	@ 1310 nm - 0.35 @ 1550 nm - 0.21		@ 1310 nm - 1.467 @ 1550 nm - 1.467	-

opticalCON MTP® ADVANCED Cable Connector Assembly

UHD 4K8K



NKO12S*

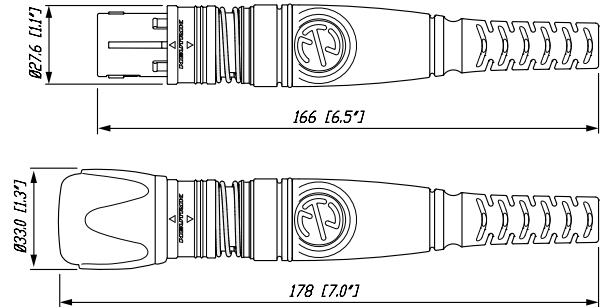

- Ruggedized and dirt-protected 12-channel fiber optic connection system
- For POINT-TO-POINT multichannel routing based on MTP® technology
- Cable connector features rugged all-metal housing and heavy-duty cable retention
- Innovative spherical shutter guarantees low maintenance
- Dust and water resistant according to IP65 in mated condition
- Easy to clean, no tools required
- Reliable Push-Pull locking mechanism
- Color-coded cable connector comes pre-assembled with a choice of mobile field cables
- Wiring methode A

Chassis Connector



NO12FDW-A with SCDP-0

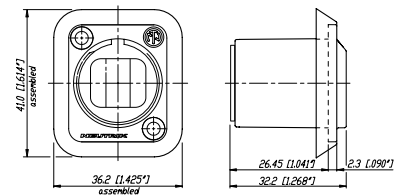

- Ruggedized and dirt-protected 12-channel fiber optic connection system
- For POINT-TO-POINT multichannel routing
- Laser protective metal shutter seals dust proof with two-component rubber gasket
- Dust and water resistant according to IP65 in mated condition
- Accommodates standard MTP® ELITE MALE connectors on the rear for simple installation *
- Rubber sealing gasket (black, blue, green to identify fiber mode)

* ... MTP® is a trademark of US Conec (www.usconec.com)

The MTP® is a multichannel fiber optic connector based on MPO (“Multifiber Push On”) technology (IEC-61754-7). MTP® connectors offers 12 fibers in a very small form factor. Breakout / Master cables to standard connectors as LC, SC, ST are in various length available.

Neutrik opticalCON MTP® cable connector



Custom MTP® breakout / master cable (LC / ST / SC)

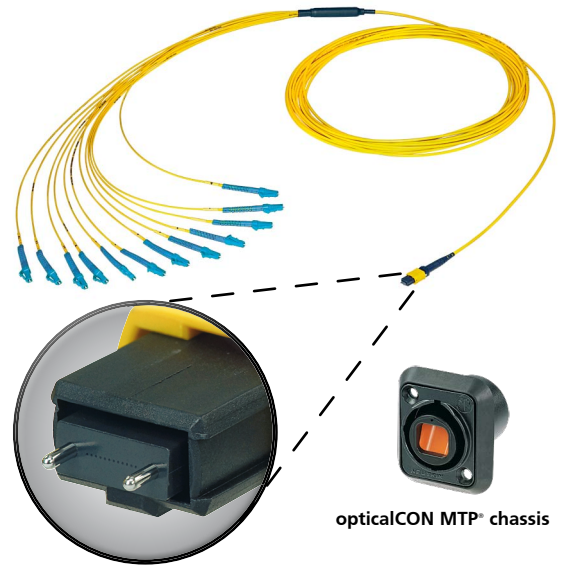

opticalCON MTP® chassis

MTP® ELITE MALE

Technical Data Cables

	Max. numbers of fibers	MODE	FIBER	Bend optimized fiber	Laser optimized fiber	Copper wires	Outer shield	Strength member	Cable retention	Overall diameter	Jacket	Optical connector	Min. bending radius	Weight	Attenuation	Bandwidth	Refraction index	Power solution								
	Multimode PC	Single mode PC / APC	50 / 125-OM3	9 / 125-G657A		AWG 16	AWG 18 (0.75 mm ²)	AWG 20	AWG 24	Copperbraid	Coated glass yarn	Stainless steel Jacket	GFR	Stainless Steel	Aramid yarn	Crimp type	(mm)	PUR black matte	LC-Duplex	LC based	(cm)	(kg / km)	(dB / km)	(MHz-km)		240 V ac / 16A
12M	12	•	-	•	-	•	•	-	-	-	-	-	-	-	•	-	8.2	•	-	•	8.2	76	@ 850 nm - 2.5 @ 1300 nm - 0.5	@ 850 nm ≥1500 @ 1300 nm ≥500	@ 850 nm - 1.482 @ 1300 nm - 1.477	-
12S (A)	12	-	•	-	•	N/A	-	-	-	-	-	-	-	-	•	-	8.2	•	-	•	8.2	76	@ 1310 nm - 0.5 @ 1550 nm - 0.3		@ 1310 nm - 1.467 @ 1550 nm - 1.467	-
X12M	12	•	-	•	-	•	-	-	-	•	-	-	-	-	•	-	10.9	•	•	•	10.9	126	@ 850 nm - 2.5 @ 1300 nm - 0.5	@ 850 nm ≥1500 @ 1300 nm ≥500	@ 850 nm - 1.482 @ 1300 nm - 1.477	-
X12S (A)	12	-	•	-	•	N/A	-	-	-	•	-	-	-	-	•	-	10.9	•	•	•	10.9	126	@ 1310 nm - 0.5 @ 1550 nm - 0.3		@ 1310 nm - 1.467 @ 1550 nm - 1.467	-

opticalCON Split Cables

SPLIT & POWER SPLIT Cables

opticalCON SPLIT



opticalCON POWER-SPLIT



- opticalCON multichannel solution based on opticalCON DUO, QUAD or MTP® connectors
- Maximum flexibility, combining up to 12-channel cables
- Custom configurations available
- 1m SPLIT fanout
- Color coding for channel identification
- Field assembly possible
- XTREME version available

- 2-, 4-, 6- and 8-channel assembly available
- Custom made cable, optimized for ENG / SNG applications
- Hybrid fiber / copper solution
- Custom Configurations
- Up to 240 Vac (16A) power transportation possible

Technical Data Cables

	Max. numbers of fibers	MODE		FIBER		Bend optimized fiber		Laser optimized fiber		Copper wires		Outer shield		Strength member		Cable retention		Overall diameter (mm)	Jacket	Optical connector		Min. bending radius (cm)	Weight (kg / km)	Attenuation (dB / km)	Bandwidth (MHz-km)	Refraction index	Power solution
		Multimode PC	Single mode PC / APC	50 / 125-OM3	9 / 125-G657A			AWG 16	AWG 18 (0.75 mm ²)	AWG 20	AWG 24	Copperbraided	Coated glass yarn	Stainless steel Jacket	GFK	Stainless Steel	Aramid yarn			Crimp type	PUR black matte						
12M	12	•	-	•	-	•	•	-	-	-	-	-	-	-	-	•	-	8.2	•	-	•	8.2	76	@ 850 nm - 2.5 @ 1300 nm - 0.5	@ 850 nm ≥ 1500 @ 1300 nm ≥ 500	@ 850 nm - 1.482 @ 1300 nm - 1.477	-
12S (A)	12	-	•	-	•	•	N/A	-	-	-	-	-	-	-	-	•	-	8.2	•	-	•	8.2	76	@ 1310 nm - 0.5 @ 1550 nm - 0.3		@ 1310 nm - 1.467 @ 1550 nm - 1.467	-
X12M	12	•	-	•	-	•	•	-	-	-	-	-	-	-	-	•	-	10.9	•	•	•	10.9	126	@ 850 nm - 2.5 @ 1300 nm - 0.5	@ 850 nm ≥ 1500 @ 1300 nm ≥ 500	@ 850 nm - 1.482 @ 1300 nm - 1.477	-
X12S (A)	12	-	•	-	•	•	N/A	-	-	-	-	-	-	-	-	•	-	10.9	•	•	•	10.9	126	@ 1310 nm - 0.5 @ 1550 nm - 0.3		@ 1310 nm - 1.467 @ 1550 nm - 1.467	-
P8M	8	•	-	•	-	•	•	3 x 1.5 mm ²	-	-	-	-	-	-	-	•	-	11.7	•	•	•	11.7	138	@ 850 nm ≤ 2.3 @ 1300 nm ≤ 0.6	@ 850 nm ≥ 1500 @ 1300 nm ≥ 500	@ 850 nm - 1.482 @ 1300 nm - 1.477	•*
P8S (A)	8	-	•	-	•	•	N/A	3 x 1.5 mm ²	-	-	-	-	-	-	-	•	-	11.7	•	•	•	11.7	138	@ 1310 nm ≤ 0.33 @ 1550 nm ≤ 0.19		@ 1310 nm - 1.467 @ 1550 nm - 1.467	•*

* Cable must be unreeled completely before use!

opticalCON DUO LITE

Cable Connector Assembly

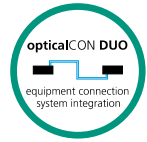

NKO2M-L*

- 2-channel fiber optic connection system
- Cost optimized fiber connection for semi and permanent installations
- Waterproof acc. to IP65 safety standard in mated condition
- Space saving design
- Push-Pull locking mechanism for save connection
- Easy to clean, no special tools required
- Compatible with standard opticalCON DUO chassis NO2-4FDW-A*

Tactical Patch Cable

Conventional patch cables are sensitive in terms of undercutting the minimum bending radius and lateral pressure. Neutrik's tactical patch cables contain a unique fiber design including a polymeric coating which allows bendings with minimal radius and increased lateral pressure. Therefore the tactical patch cables are the right choice for permanent or semi-permanent applications.

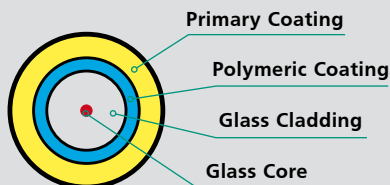

opticalCON QUAD LITE

Cable Connector Assembly

UHD 4K8K

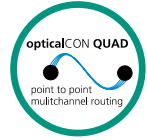

NEW



NKO4M-L*

- 4-channel fiber optic connection system
- Waterproof acc. to IP65 safety standard in mated condition
- Push-pull locking mechanism
- Recommended for POINT-TO-POINT connection
- Easy to clean, no special tools required
- Tactical patch cable
- Compatible with standard opticalCON ADVANCED NO4FDW-A chassis

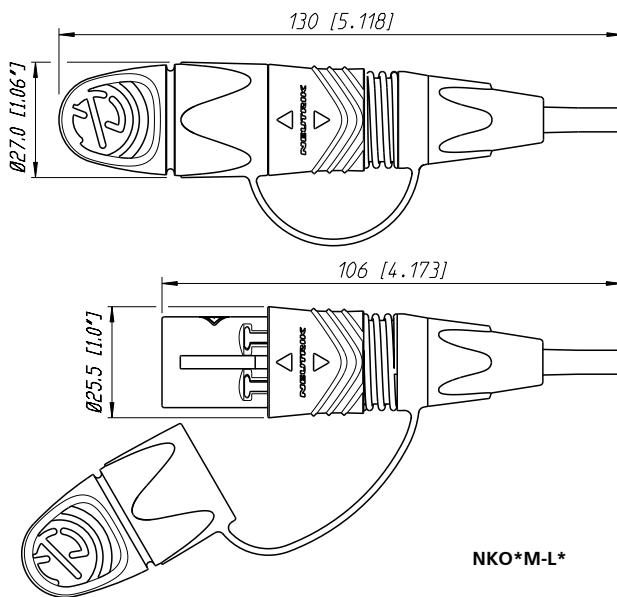

NKO*M-L*

opticalCON MTP® LITE Cable Connector Assembly

UHD 4K8K

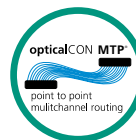

NEW



NK012M-L*

- 12-channel MTP® based fibre optic connection system
- Waterproof acc. to IP65 safety standard in mated condition
- Recommended for multi-signal transmission
- Push-pull locking mechanism
- Custom color coding
- Rugged plastic housing
- Rubber protection cap
- Compatible with standard opticalCON ADVANCED NO12FDW-A chassis

Technical Data Cables

	Max. numbers of fibers	MODE		FIBER	Bend optimized fiber	Laser optimized fiber	Copper wires				Outer shield			Strength member		Cable retention		Overall diameter (mm)	Jacket	Optical connector	Min. bending radius (cm)	Weight (kg / km)	Attenuation (dB / km)	Bandwidth (MHz-km)	Refraction index	Power solution	
		Multimode PC	Single mode PC / APC				50 / 125-OMB	9 / 125-G657A2	AWG 16	AWG 18 (0.75 mm ²)	AWG 20	AWG 24	Copperbraid	Coated glass yarn	Stainless steel Jacket	GFK	Stainless Steel										Aramid yarn
2M-L	2	•	-	•	•	•	-	-	-	-	-	-	-	-	•	-	-	3.0	•	-	•	3.0	13	@ 850 nm ≤ 3.0 @ 1300 nm ≤ 1.0	@ 850 nm ≥ 1500 @ 1300 nm ≥ 500	@ 850 nm - 1.481 @ 1300 nm - 1.476	-
2S-L	2	-	•	-	•	•	-	-	-	-	-	-	-	-	•	-	-	3.0	•	-	•	3.0	13	@ 1310 nm ≤ 0.35 @ 1550 nm ≤ 0.21	@ 850 nm ≥ 1500 @ 1300 nm ≥ 500	@ 1310 nm - 1.467 @ 1550 nm - 1.468	-
4M-L	4	•	-	•	•	•	-	-	-	-	-	-	-	-	•	-	-	3.5	•	-	•	3.5	14	@ 850 nm ≤ 3.0 @ 1300 nm ≤ 1.0	@ 850 nm ≥ 1500 @ 1300 nm ≥ 500	@ 850 nm - 1.481 @ 1300 nm - 1.476	-
4S-L	4	-	•	-	•	•	-	-	-	-	-	-	-	-	•	-	-	3.5	•	-	•	3.5	14	@ 850 nm ≤ 3.0 @ 1300 nm ≤ 1.0	@ 850 nm ≥ 1500 @ 1300 nm ≥ 500	@ 850 nm - 1.481 @ 1300 nm - 1.476	-
12M-L	12	•	-	•	•	•	-	-	-	-	-	-	-	-	•	-	-	3.5	•	-	•	3.5	14	@ 850 nm ≤ 3.0 @ 1300 nm ≤ 1.0	@ 850 nm ≥ 1500 @ 1300 nm ≥ 500	@ 850 nm - 1.481 @ 1300 nm - 1.476	-
12S-L	12	-	•	-	•	•	-	-	-	-	-	-	-	-	•	-	-	3.5	•	-	•	3.5	14	@ 850 nm ≤ 3.0 @ 1300 nm ≤ 1.0	@ 850 nm ≥ 1500 @ 1300 nm ≥ 500	@ 850 nm - 1.481 @ 1300 nm - 1.476	-



Technical Data

opticalCON ADVANCED & LITE

OPTICAL - CABLE CONNECTOR		ADVANCED			LITE		
		DUO	QUAD	MTP [®]	DUO	QUAD	MTP [®]
		LC-Duplex	PC	MTP [®] ELITE female	LC-Duplex	PC	MTP [®] ELITE female
Optical connector							
Fiber	Multi mode, Single mode PC / APC	●	●	●	●	●	●
Insertion loss	< 0.5 dB / connection	●	●	< 0.9	●	●	< 0.9
min. Return Loss	PC > 50 dB	●	●	●	●	●	●
	APC > 60 dB	●	●	●	●	●	●
Wiring	ISO / IEC 11801 Methode A	-	-	●	-	-	-
MECHANICAL							
Insertion / withdrawal force	< 45 N	●	●	●	●	●	●
Lifetime (mating cycles)	> 5'000	●	●	> 2'500	> 2'500	> 2'500	> 1'500
Cable retention force	Fiber only > 500 N	●	●	●	●	●	●
	Hybrid > 500 N	●	-	-	●	●	●
	SMPTE > 500 N	●	-	-	●	●	●
ELECTRICAL							
Number of electrical contacts		4	-	-	-	-	-
Rated current	6 A	NKO2M-H1	-	-	-	-	-
	10 A (contact 1+4)	NKO2S(A)-S1	-	-	-	-	-
Contact resistance	< 7 mΩ	●	-	-	-	-	-
Insulation resistance	- initial: > 10 GΩ	●	-	-	-	-	-
	- after damp heat test: > 1 GΩ	●	-	-	-	-	-
Dielectric strength	1500 V dc	●	-	-	-	-	-
Rated voltage	50 V ac	● ¹	-	-	-	-	-
MATERIAL							
Shell	Zinc diecast (ZnAl4Cu1), black chrome plating PA6	●	●	●	-	-	-
		-	-	-	●	●	●
Insert / Insulation	Polyamid PA 6, PBT 30% GR, PBT 50% GR	●	●	●	-	-	-
Insert colour	MM: black, SM PC: blue, SM APC: green	●	●	●	-	-	-
Contacts	- male: Brass (CuZn39Pb3) - female: Bronze (CuSn6)	●	-	-	-	-	-
		-	-	-	-	-	-
Contact surface	Gold (gal 0.2 μm Au over 2 μm Ni)	●	-	-	-	-	-
Strain relief	Brass, Ni plated	●	●	●	●	●	●
Bushing	ZnAl4Cu1 PA6	●	●	●	-	-	-
		-	-	-	●	●	●
Boot	EPDM, rubber boot	●	●	●	●	●	●
Slit sleeve	ceramics	-	-	-	●	●	●
ENVIRONMENTAL							
Operating temperature	-40°C to +75°C	●	●	●	●	●	●
	flammability UL94 HB	●	●	●	●	●	●
Solderability	complies with IEC 68-2-20	●	-	-	-	-	-
Protection class in mated condition	IP65	●	●	●	●	●	●

¹ ... Not compatible to SMPTE 304M standard. Suitable for indoor (studio) camera links considering specific conditions acc. to IEC 60664-1 like pollution degree 1, overvoltage category 1 and rated voltage. For detailed information ask for the White Paper "opticalCON @ SMPTE Indoor Applications".

OPTICAL - CHASSIS

		DUO	QUAD	MTP*
Optical connector		LC-Duplex	PC	MTP* ELITE female
		Feedthrough	Feedthrough	Feedthrough
Fiber	Multi mode, Single mode PC / APC	●	●	●
Insertion loss	< 0.5 dB / connection	●	●	< 0.9
min. Return Loss	PC > 50 dB	●	●	●
	APC > 60 dB	●	●	●
Wiring	ISO / IEC 11801 Methode A	-	-	-

MECHANICAL

Insertion / withdrawal force	< 45 N	●	●	●
Lifetime (mating cycles)	> 5'000	●	●	> 2'500
Cable retention force	Fiber only > 500 N	-	-	-
	Hybrid > 500 N	-	-	-
	SMPTE > 500 N	-	-	-

ELECTRICAL

Number of electrical contacts		4 (5)	-	-
Rated current	6 A	●	-	-
	10 A (contact 1+4)	●	-	-
Contact resistance	< 7 mΩ	●	-	-
Insulation resistance	- initial: > 10 GΩ	●	-	-
	- after damp heat test: > 1 GΩ	●	-	-
Dielectric strength	1500 V dc	●	-	-
Rated voltage	50 V ac	● ¹	-	-

MATERIAL











Shell	Zinc diecast (ZnAl4Cu1),			
	black chrome plating	●	●	●
	PA6	-	-	-
Insert / Insulation	Polyamid PA 6, PBT 30% GR,			
	PBT 50% GR	●	●	●
Insert colour	MM: black, SM PC: blue,			
	SM APC: green	●	●	●
Contacts	- male: Brass (CuZn39Pb3)	-	-	-
	- female: Bronze (CuSn6)	●	-	-
Contact surface	Gold (gal 0.2 μm Au over 2 μm Ni)	●	-	-
Strain relief	Brass, Ni plated	-	-	-
Bushing	ZnAl4Cu1	-	-	-
	PA6	-	-	-
Boot	EPDM, rubber boot	-	-	-
Slit sleeve	ceramics	●	●	●

ENVIRONMENTAL

Operating temperature	-40°C to +75°C	●	●	●
	flammability UL94 HB	●	●	●
Solderability	complies with IEC 68-2-20	●	-	-
Protection class in mated condition	IP65	●	●	●

Ordering Information

Mobile Cables

Connect System	Cable												
<p>opticalCON DUO LITE</p> 	<table border="0"> <tr> <td>Multimode</td> <td>2M-L 4M-L 12M-L</td> <td> 2-channel standard</td> </tr> <tr> <td>Single mode</td> <td>2S (A)-L 4S (A)-L 12S (A)-L</td> <td> 4-channel standard  12-channel standard</td> </tr> </table>	Multimode	2M-L 4M-L 12M-L	 2-channel standard	Single mode	2S (A)-L 4S (A)-L 12S (A)-L	 4-channel standard  12-channel standard						
Multimode	2M-L 4M-L 12M-L	 2-channel standard											
Single mode	2S (A)-L 4S (A)-L 12S (A)-L	 4-channel standard  12-channel standard											
<p>opticalCON DUO ADVANCED</p>  <p>NKO2*</p>	<table border="0"> <tr> <td>Multimode</td> <td>2M X2M XX2M 2M-H1</td> <td> 2-channel standard  X-TREME ARMORED  HYBRID </td> </tr> <tr> <td>Single mode</td> <td>2S (A) X2S (A) XX2S (A) 2S (A) - S1 2S (A) - S5</td> <td> 2-channel standard  X-TREME ARMORED  SMPTE  LOW VOLTAGE </td> </tr> </table>	Multimode	2M X2M XX2M 2M-H1	 2-channel standard  X-TREME ARMORED  HYBRID 	Single mode	2S (A) X2S (A) XX2S (A) 2S (A) - S1 2S (A) - S5	 2-channel standard  X-TREME ARMORED  SMPTE  LOW VOLTAGE 						
Multimode	2M X2M XX2M 2M-H1	 2-channel standard  X-TREME ARMORED  HYBRID 											
Single mode	2S (A) X2S (A) XX2S (A) 2S (A) - S1 2S (A) - S5	 2-channel standard  X-TREME ARMORED  SMPTE  LOW VOLTAGE 											
<p>opticalCON QUAD ADVANCED</p>  <p>NKO4*</p>	<table border="0"> <tr> <td>Multimode</td> <td>4M X4M XX4M</td> <td> 4-channel standard  X-TREME ARMORED </td> </tr> <tr> <td>Single mode</td> <td>4S (A) X4S (A) XX4S (A)</td> <td> 4-channel standard  X-TREME ARMORED </td> </tr> </table>	Multimode	4M X4M XX4M	 4-channel standard  X-TREME ARMORED 	Single mode	4S (A) X4S (A) XX4S (A)	 4-channel standard  X-TREME ARMORED 						
Multimode	4M X4M XX4M	 4-channel standard  X-TREME ARMORED 											
Single mode	4S (A) X4S (A) XX4S (A)	 4-channel standard  X-TREME ARMORED 											
<p>opticalCON MTP® ADVANCED</p>  <p>NKO12*</p>	<table border="0"> <tr> <td>Multimode</td> <td>12M X12M</td> <td> 12-channel standard</td> </tr> <tr> <td>Single mode</td> <td>12S (A) X12S (A)</td> <td> X-TREME</td> </tr> </table>	Multimode	12M X12M	 12-channel standard	Single mode	12S (A) X12S (A)	 X-TREME						
Multimode	12M X12M	 12-channel standard											
Single mode	12S (A) X12S (A)	 X-TREME											
<p>opticalCON ADVANCED</p> <p>opticalCON SPLIT</p>  <p>NKOY*</p> <p>opticalCON POWER SPLIT</p>  <p>NKOYP*</p>	<table border="0"> <tr> <td>Multimode</td> <td>YPM</td> <td> POWER-SPLIT</td> </tr> <tr> <td>Single mode</td> <td>YPS (A)</td> <td></td> </tr> <tr> <td>Multimode</td> <td>YM YXM</td> <td> 12-channel standard</td> </tr> <tr> <td>Single mode</td> <td>YS (A) YXS (A)</td> <td> X-TREME</td> </tr> </table>	Multimode	YPM	 POWER-SPLIT	Single mode	YPS (A)		Multimode	YM YXM	 12-channel standard	Single mode	YS (A) YXS (A)	 X-TREME
Multimode	YPM	 POWER-SPLIT											
Single mode	YPS (A)												
Multimode	YM YXM	 12-channel standard											
Single mode	YS (A) YXS (A)	 X-TREME											



Find the free Download of opticalCON part number generator on www.neutrik.com section „opticalCON“.

Cable length [m] for Packaging



0 ... Airspool



1 ... opticalCON Case



2 ... Drum Schill GT310



3 ... Drum Schill GT380



4 ... Drum Schill HT582



5 ... Drum Schill GT450

< 4000	-	-	-	-	-
< 2000	< 30	< 200	< 400	< 1000	< 500
< 2000	< 30	-	< 100	< 300	< 150
< 100	< 30	-	< 75	< 100	< 100
< 2000	< 30	-	< 125	< 300	< 150
< 2000	< 30	< 200	< 400	< 1000	< 500
< 2000	< 30	-	< 100	< 300	< 150
< 100	< 30	-	< 75	< 100	< 100
< 2000	< 30	-	< 100	< 300	< 150
< 2000	< 30	-	< 150	< 500	< 250
< 2000	< 30	< 150	< 300	< 800	< 400
< 2000	< 30	-	< 100	< 300	< 150
< 100	< 30	-	< 75	-	< 100
< 2000	< 30	< 150	< 300	< 800	< 400
< 2000	< 30	-	< 100	< 300	< 150
< 100	< 30	-	< 75	-	< 100
< 2000	-	-	< 125	< 300	< 200
< 2000	-	-	-	< 200	< 100
< 2000	-	-	< 125	< 300	< 200
< 2000	-	-	-	< 200	< 100
< 2000	-	-	- *	< 200	< 100
< 2000	-	-	- *	< 200	< 100
< 2000	-	-	- *	< 300	< 200
< 2000	-	-	-	< 200	< 100
< 2000	-	-	- *	< 300	< 200
< 2000	-	-	-	< 200	< 100

* ... DUO-SPLIT on request

Ordering Information

Mobile Cables

Custom Cable Assembly Attributes

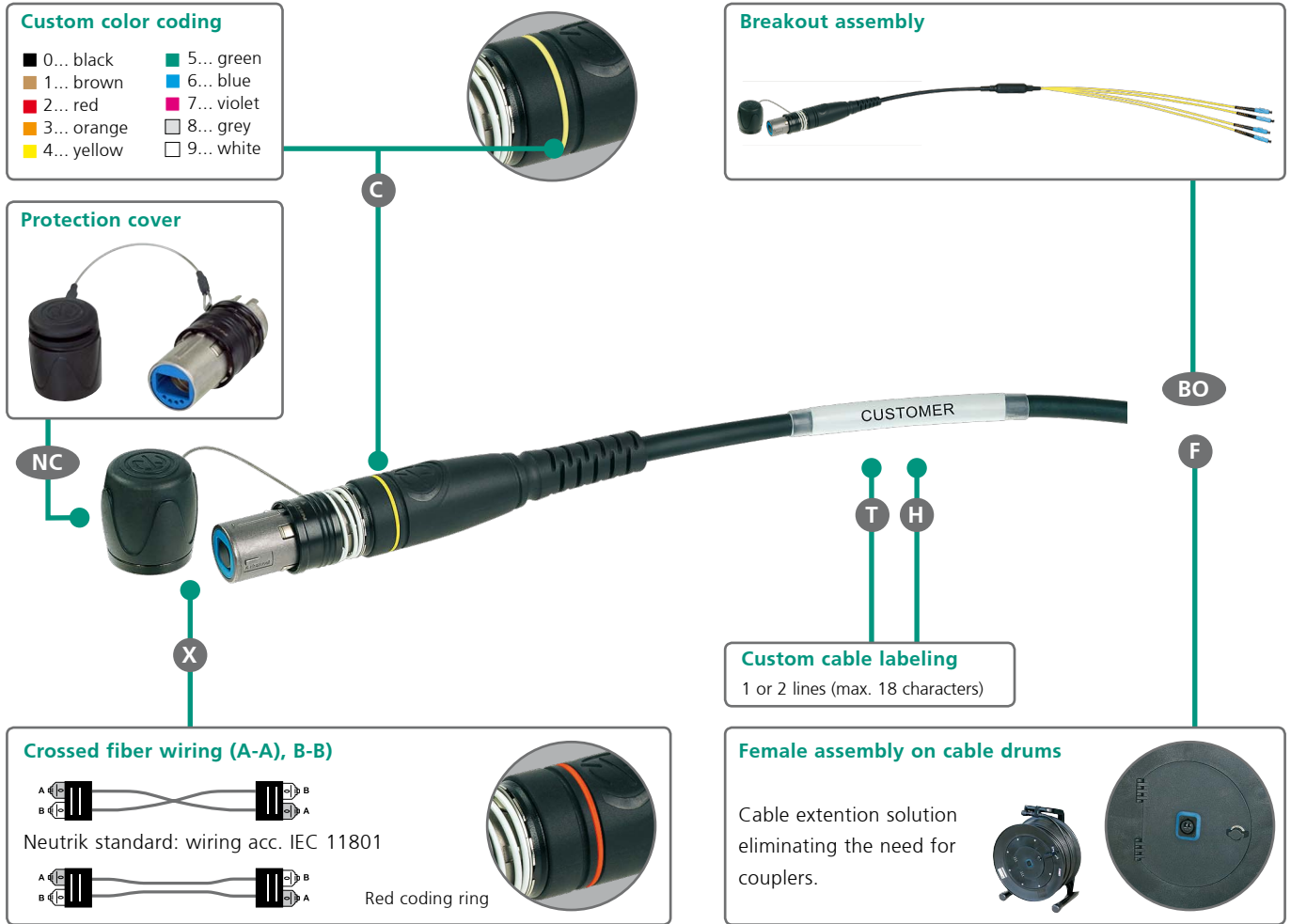

Attributes

X Crossed fiber wiring A-A, B-B	H translucent heat shrink (7.5 cm long)
F Female drum assembly, only packaging -2 to -5	BO [] Breakout assembly (LC, SC, ST)
C [] Connector color coding (0-9)	NC Noise cancelling protection cover (SCNO*X-A-NC)
T [L1, L2] Custom cable labeling	

Ordering Example

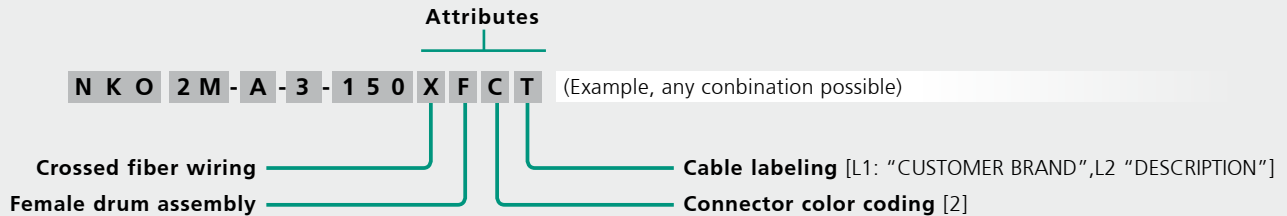

Mobile Cables

Custom Cable Assembly Attributes for Split Cables

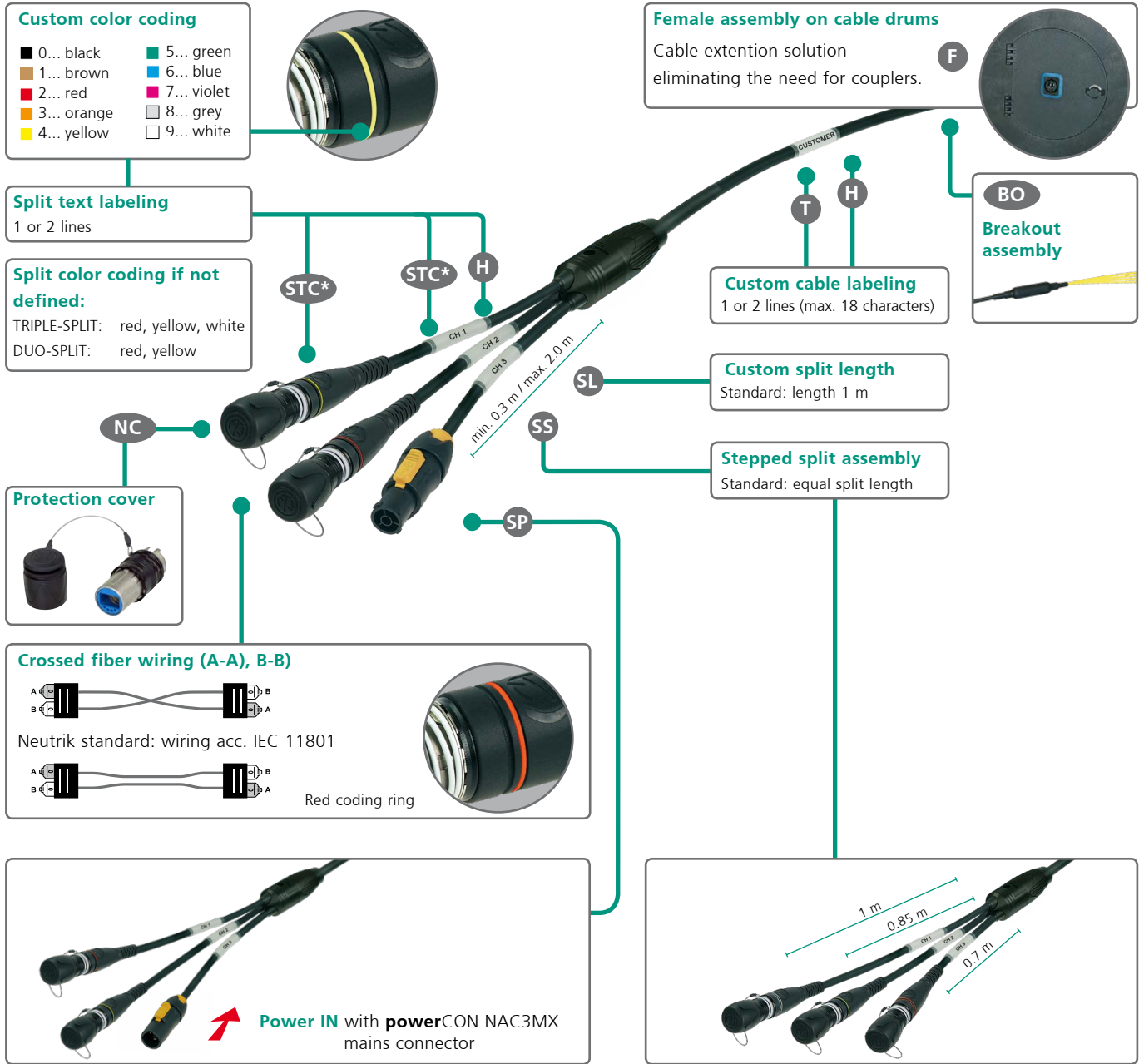

Attributes for Split Cables

X	crossed wired fibers A-A, B-B	SS	stepped split assembly
F	female drum assembly, only packaging -2 to -5	SL []	split length in meter
T [L1, L2]	custom cable labeling	SP	inverted powerCON IN/OUT, only packaging -2 to -5
H	translucent heat shrink (7.5 cm long)	BO []	Breakout assembly (LC, SC, ST)
STC* [L1 " "; L2 " "]	split text to color (0-9)	NC	Noise cancelling protection cover (SCNO*X-A-NC)

Ordering Information

Chassis Connectors & Breakout Adapter

CHASSIS



NO2-4FDW-A



NO4FDW-A



NO12FDW-A

	Type	Colour	Plating	Fiber	Solder contacts	Shell ground contact	Wiring
NO2-4FDW-A	Chassis	¹⁾	Black Chrome	2	4	-	-
NO2-4FDW-1-A	Chassis	¹⁾	Black Chrome	2	4	1	-
NO4FDW-A	Chassis	¹⁾	Black Chrome	4	-	-	-
NO12FDW-A	Chassis	¹⁾	Black Chrome	12	-	-	-

¹⁾ ... Coloured labeling to indicate the fiber mode included (black: M, blue: SM PC, green: SM APC)

COUPLER



NAO2S-H1W-A



NAO4MW-A



NAO4SWX-A ²⁾



NAO12MW-A

	Type	Colour	Plating	Fiber	Solder contacts	Shell ground contact	Wiring
NAO2M-H1W-A ²⁾	Coupler	black	black	2 x LC-Duplex Multimode PC	4 x 0.75 mm ²	-	
NAO2S-H1W-A ²⁾	Coupler	blue	black	2 x LC-Duplex Single mode PC	4 x 0.75 mm ²	-	
NAO2SA-H1W-A ²⁾	Coupler	green	black	2 x LC-Duplex Single mode APC	4 x 0.75 mm ²	-	
NAO4MW-A ²⁾	Coupler	black	black	4 x Multimode PC	-	-	
NAO4SW-A ²⁾	Coupler	blue	black	4 x Single mode PC	-	-	
NAO4SAW-A ²⁾	Coupler	green	black	4 x Single mode APC	-	-	
NAO4SW-A-X	Coupler	red	black	4 x Single mode PC	-	-	
NAO12MW-A	Coupler	black	black	12 x Multimode PC	-	-	
NAO12SAW-A	Coupler	green	black	12 x Single mode APC	-	-	

²⁾ ... add attribute X for crossed fiber wiring

MTP® Breakout / Master Cable

- Low loss Breakout / Master cable* (IL/connection < 0.4 dB)
- Grade A premium ferrules
- LC / SC / ST breakout connectors
- Custom length possible
- Split length: 61 cm

NKOB12SA-0-***	MTP® / LC - patch cable, Single mode PC
NKOB12M-A-0-***	MTP® / LC - patch cable, Multimode PC

Attribute: BO [] ... breakout connectors (ST, SC), APC on request

* ... Fiber optic transmission parameters exceeding standard quality, suitable for measurement applications.

Notice: Standard for out configuration comes with LC (PC) connectors.

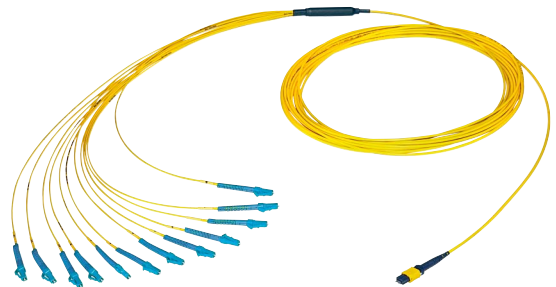

Custom MTP® patch / master cable (LC / ST / SC)

Transceiver Adapter & Accessories

TRANSCEIVER ADAPTER



NAO2SA-SFP-LC

NAOBO - Breakout ADAPTER

- Flexible chassis mounting solution
- Adaption solution to meet existing non-opticalCON fiber installation



NAOBO (KIT)



Application example

NAO2M-SFP-LC	grey	MM Transceiver Adapter + opticalCON chassis (NO2-4FDW-A) without copper contacts
NAO2S-SFP-LC	blue	SM Transceiver Adapter + opticalCON chassis (NO2-4FDW-A) without copper contacts
NAO2SA-SFP-LC	green	SM APC Transceiver Adapter + opticalCON chassis (NO2-4FDW-A) without copper contacts
NAOBO		Breakout-Adapter-Kit consisting of 1 NAOBO plastic housing, 1 counter nut, 1 90° rear shell, 1 PG-gland, 1 cable tie and 2 screws

ACCESSORIES



SCNO-FDW-A	Rugged sealing cover for opticalCON chassis connectors
SCD-NC	Rubber sealing cover for opticalCON chassis connectors
SCNO*X-A	Rubber coated protection cover for opticalCON cable connectors, including black chrome front housing
SCNO*X-A-NC	Light weight noise cancelling rubber protection cover for opticalCON cable connectors, including front housing
SCNO*X-R ¹⁾	Rubber coated protection cover for opticalCON cable connectors, ruthenium plated front housing, upgrade kit old connector
SCDP-*	D-Size sealing gaskets for chassis, color coding (*: 0- black, 2- red, 4- yellow, 5- green, 6- blue, 9- white)
NOR-*	Color coding ring for cable connector chassis
SCCD-W	Spring-loaded cover to seals D-size chassis connectors, IP65 rated
NAO4ML-A	opticalCON QUAD LOOP connector, multimode
NAO4SL-A	opticalCON QUAD LOOP connector, single mode

*: 0- black, 1- brown, 2- red, 3-orange, 4- yellow, 5- green, 6- blue, 7- violet, 8- grey, 9- white

¹⁾:find part numbers on www.neutrik.com

Advanced Pulling Solutions

- Pulling sock simplifies installation
- Pulling force > 100 kg
- Protects connectors in mated / unmated condition

Single pulling sock
FOPS-SINGLE



Split pulling sock
FOPS-SPLIT



FOPS-SPLIT

FOPS-SPLIT	Split cable pulling sock
FOPS-SINGLE	Single cable pulling sock for DUO / QUAD or MTP® cables.

Ordering Information

Fiber Optic Measurement & Cleaning Kit



CAS-FOCD-ADV

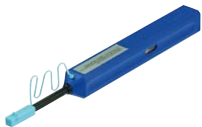

FOCD-DC125/250



FOCD-DCM



CAS-FOMD



FOMD-TC-SM1550



FOMD-FM-MM

CAS-FOCD	Fiber Optic Cleaning Devices - CASE contains hand microscope, opticalCON measurement adapter, cleaning set	
	FOCD-CF ¹⁾	Cleaning Fluid
	FOCD-DC125 ¹⁾	DRY Cleaner 1.25 mm
	FOCD-DC250 ¹⁾	DRY Cleaner 2.5 mm
	FOCD-DCM	DRY Cleaner MTP®, cleaning brush for guidance holes
	FOCD-DW ¹⁾	Lint-free dry wipes for fiber cleaning
CAS-FOMD-ADV	Fiber Optic Measurement Devices - CASE contains power source frame, 1.25 mm adapter and multimode attenuator	
	FOMD-TC-MM850 ²⁾	Transceiver 850 nm multimode
	FOMD-TC-SM1310 ²⁾	Transceiver 1310 nm single mode
	FOMD-TC-SM1550 ²⁾	Transceiver 1550 nm single mode
	FOMD-FM-MM ²⁾	Fiber meter multimode
	FOMD-FM-SM ²⁾	Fiber meter single mode
	¹⁾ ... refill consumable, in CAS-FOCD included	
	²⁾ ... combine with CAS-FOMD	

opticalCON Connector Field Assembly



opticalCON connector Field assembly

- Neutrik opticalCON field assembly kit
- Based on Corning UniCam pre-polished LC connectors
- No additional tooling required
- Requires completion of a certified Neutrik opticalCON field assembly training
- Find more details on www.neutrik.com

Corning UniCam



- Field Assembly option now also available with fusion splice technology (fusion splice machine not included)

opticalCON powerMONITOR

On air monitoring of fiber optic transmission quality

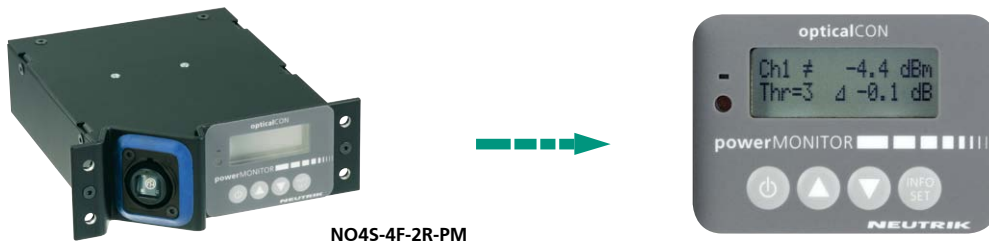

The opticalCON powerMONITOR is a cost-saving, purpose-built measurement (monitoring) device for professional fiber optic broadcast, audio and video applications.

With simultaneous monitoring of attenuation for up to 4 transmission channels, powerMONITOR provides an immediate,

“on air” view into fiber optic signal strength. Visual and audible alarms can be set individually for each fiber channel, based on each channel’s power budget. powerMONITOR provides clear status information, delivers early warnings for potential problems, and assists with maintenance scheduling.

- On-air monitoring of fiber optic transmission quality
- Simultaneous power measurement (+0.0/-0.1dB measurement accuracy) of up to 4 channels
- Programmable threshold alarms
- Rack mount and mobile units
- Operates on rechargeable battery power or on mains power with fail-safe battery backup in case of unexpected mains power interruption
- Low loss (0.5dB maximum split loss)
- Wavelength selectable: multimode 850 nm or 1300 nm, single mode 1310 nm, 1550 nm or WDM (wave division multiplexing)

1 RU & 3 RU 19" Rack units



NO45-4F-2R-PM (up to two power Monitors)



up to 9 power Monitors

Breakout Box

NEW



NO45BB4D-PM-A

Ordering Information

powerMONITOR

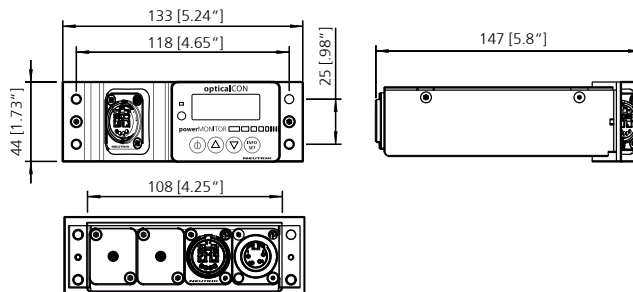

Front view: e.g. 4F (opticalCON QUAD)

Rear view: e.g. 2R (opticalCON DUO)



Ordering Example

N O 2 S - 2 F - 2 R P M - A ¹⁾

Neutrik opticalCON	Channel	Mode	Chassis Front	Chassis Rear	power MONITOR
	2	S	2F (DUO)	2R (DUO)	PM
		SA			
4	M	4F (QUAD)	4R (QUAD)		

¹⁾ ... add attribute X for crossed fiber wiring

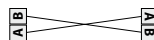

Breakout & Panel Solutions

Breakout Box

- Breakout boxes are used to split multichannel connections as the opticalCON QUAD and MTP to either dual or single channels
- Dust and waterproof according to IP67 in mated condition



NO45BB2D-A

19" Z-Panels & Plates

- Space saving design, ideal for cramped rack applications such as OB truck I/O panels
- Frame plate can be loaded with opticalCON DUO or QUAD and E2000 or ST or SC
- Frames can be equipped with frame plates (D-shape) or blind plates
- Best cable bend protection
- 1 RU or 3 RU frame

NZPF1RU



NZPF3RU



Application Example:

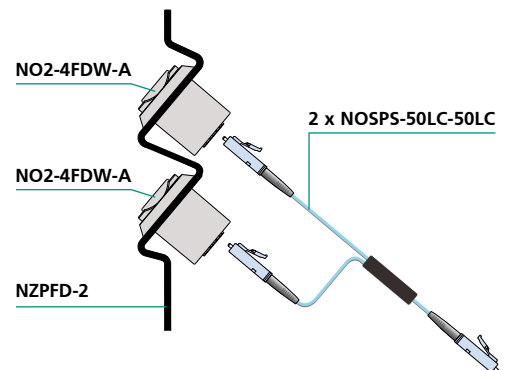

Panel frame 1RU

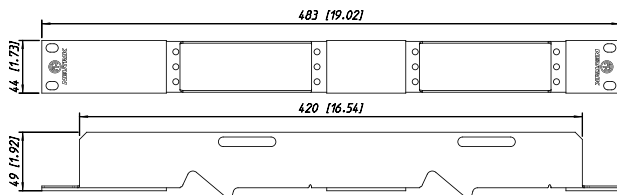

Panel frame 3RU

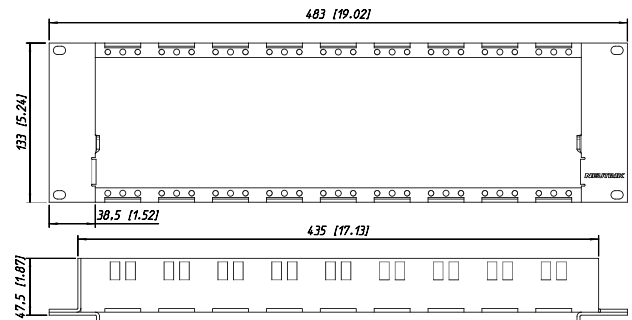

Ordering Information

D-Shape Z-Panels

Z-Panels

Panel frame 1RU - NZPF1RU

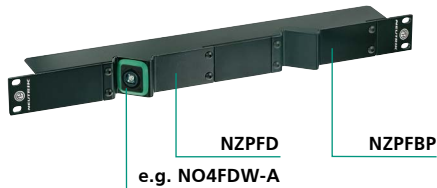

Panel frame 3RU - NZPF3RU

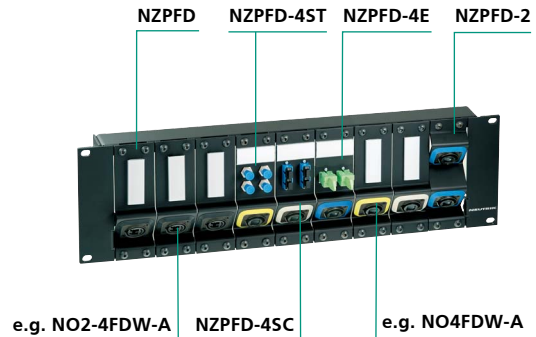

Angled rack panel - NZP1RU-8



NOSPS-50LC-50LC



Panel Frame

NZPF1RU	Panel frame 1RU opticalCON
NZPF3RU	Panel frame 3RU opticalCON
NZP1RU-8	Panel 1RU, 8 D size cutouts

Panel Plate

NZPFD	Panel frame plate opticalCON
NZPFBP	Panel frame blind plate
NZPFD-2	Panel frame plate 2 D size cutouts (works only on NZPF3RU Panel)
NZPFD-4E	Panel frame plate 1 D size cutout, 2 E2000 compact chassis cutouts
NZPFD-4SC	Panel frame plate 1 D size cutout, 2 SC compact chassis cutouts
NZPFD-4ST	Panel frame plate 1 D size cutout, 4 ST chassis cutouts
NZPFD-4CS-S	Panel frame plate 1 D size cutout, 4 SC simplex cutouts

Splitter

NOSPM-LC50-LC50	Multimode 1 x 2 splitter LC*
NOSPS-LC50-LC50	Single mode PC 1 x 2 splitter LC*

* ... other connectors (SC, ST, E200) on request

Ordering Information

Breakout Box & Power Supply

Breakout Box

NEW



NO4SBB2D-A

NO4SBB2D-A ¹⁾	1 x NO4FDW-A to 2 x NO2-4FDW-A, Single mode PC
NO4SABB2D-A ¹⁾	1 x NO4FDW-A to 2 x NO2-4FDW-A, Single mode APC
NO4MBB2D-A ¹⁾	1 x NO4FDW-A to 2 x NO2-4FDW-A, Multimode PC
NO4SBB4D-A	1 x NO4FDW-A to 4 x NO2-4FDW-A, Single mode PC
NO4SABB4D-A	1 x NO4FDW-A to 4 x NO2-4FDW-A, Single mode APC
NO4MBB4D-A	1 x NO4FDW-A to 4 x NO2-4FDW-A, Multimode PC
NO12SABB6D-A	1 x NO12FDW-A to 6 x NO2-4FDW-A, Single mode APC (MTP® connector)
NO12MBB6D-A	1 x NO12FDW-A to 6 x NO2-4FDW-A, Multimode PC
NO12SABB3Q-A	1 x NO12FDW-A to 3 x NO4FDW-A, Single mode APC (MTP® connector)
NO12MBB3Q-A	1 x NO12FDW-A to 3 x NO4FDW-A, Multimode PC

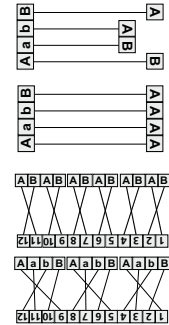

Breakout Box with powerMONITOR

NEW



NO4SBB4D-PM-A

NO*BB1*-PM-A ¹⁾	breakout box equipped with opticalCON powerMONITOR ¹⁾ ... add attribute X for crossed fiber wiring
----------------------------	--



Power Supply for powerMONITOR



NOPS-1RU-PM



NOPS-3RU-PM



NOPS-E-PM

NOPS-1RU-PM	opticalCON powerMONITOR 5W Power Supply, powers up to 2 power monitors, Intern. AC plugs included
NOPS-3RU-PM	opticalCON powerMONITOR 15W Power Supply, 1 + 3RU use, powers up to 9 power monitors, IEC power socket
NOPS-E-PM	opticalCON powerMONITOR, power supply extension cable to daisy-chain power



Applications

Applications

Audio

CLAIR BROTHERS, USA

Clair Brothers uses the opticalCON fiber systems for audio signal transmission worldwide as the standard 100 meter runs on all of their high end digital mixing console systems. They also use opticalCON fiber systems under extremely harsh outdoor conditions to distribute digital audio between delay systems (loudspeaker delay) on their larger outdoor festival situations in the US and Europe.

The inherent bulk of the opticalCON system works far better for Clair than previous lightweight fiber systems as it lays flatter and is less susceptible to kinks and being caught up under chairs and stairways in typical arena situations.

»THE CONNECTORS HAVE PROVEN TO BE VERY RELIABLE COMPARED TO PREVIOUS DESIGNS WE HAVE TRIED IN THE PAST. IN FACT ONE SYSTEM PERFECTLY SURVIVED A TORNADO IN ITALY AT AN OUT-DOOR SHOW.«

Howard Page, senior director of engineering, Clair Brothers

Clair Brothers is the world's largest touring company specialized in sound and staging. Through the years Clair Brothers has handled shows for some of the biggest names in the music industry, with artists such as The Eagles, AC/DC, Jonas Brothers and Sir Elton John to name a few. In January of 2009, Clair Brothers was responsible for the post inauguration event for US President Obama, where many thousands of people gathered to hear him speak in a large outdoor event.

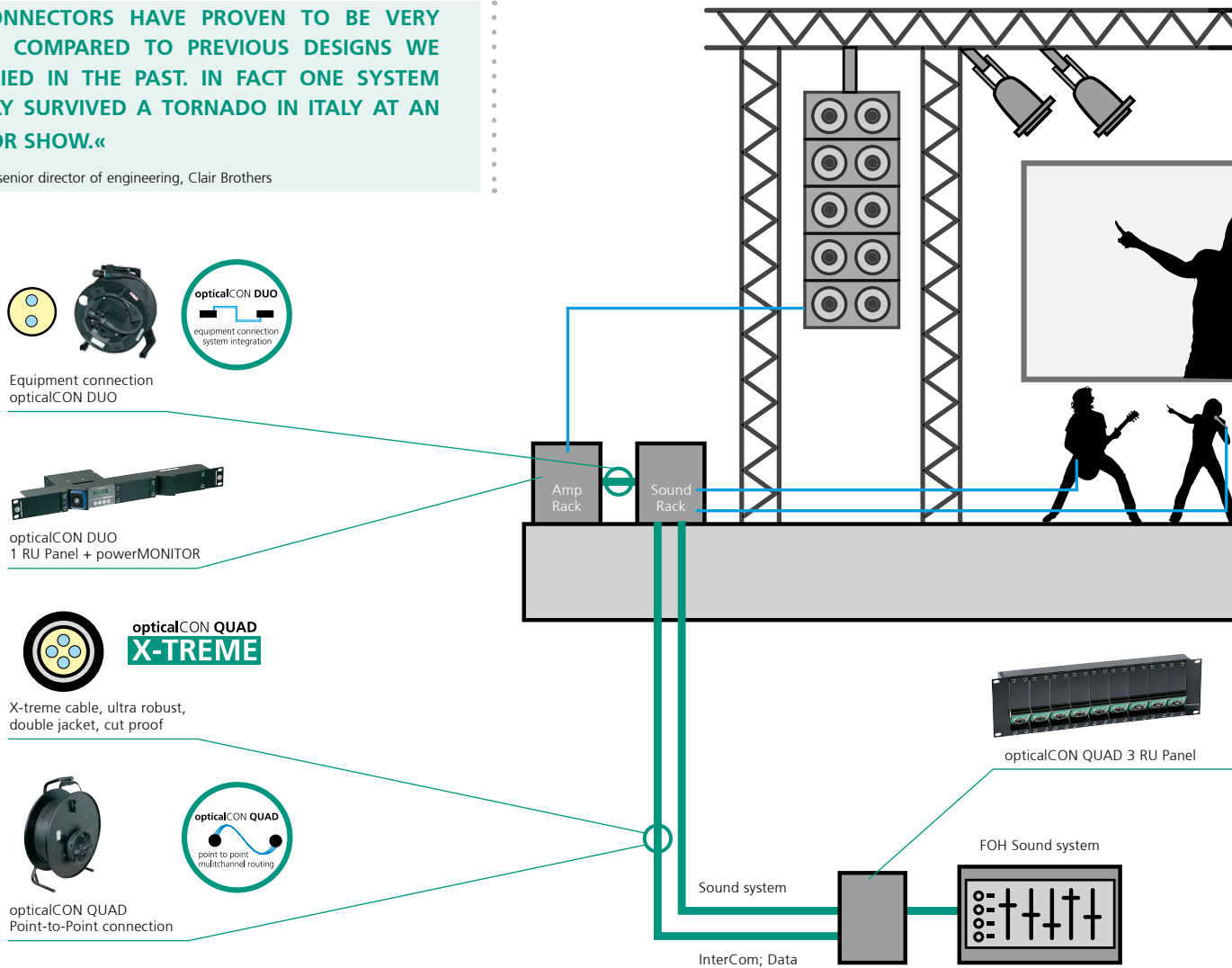

Video / Lighting

SOLOTECH, CANADA

Solotech uses the opticalCON connection system to transmit DVI video signals, ethernet control data (KVM), DMX networks as well as audio signals.

They work with the very latest lighting equipment and find as well innovative ways to use existing technology. The ideas of a creative team are turned into dazzling reality using articulated projectors, control boards, dimmers and an unparalleled array of cutting edge accessories. Color washes, re-imagined spaces, giant projections moving over any surface and 360° projections all spellbind audiences using the breathtaking world of visual effects.

30 years of providing lighting, video, sound and new media at both national and international levels makes Solotech known as an expert in video and lighting applications. Solotech has spent more than 10 years on tour with world stars like Celine Dion, André Rieu, the Cirque du Soleil and numerous other major artists.

**»THIS SYSTEM IS FANTASTIC!
NEVER HAD A FAILURE YET.«**

Cyril Bême, Operations Director, Solotech

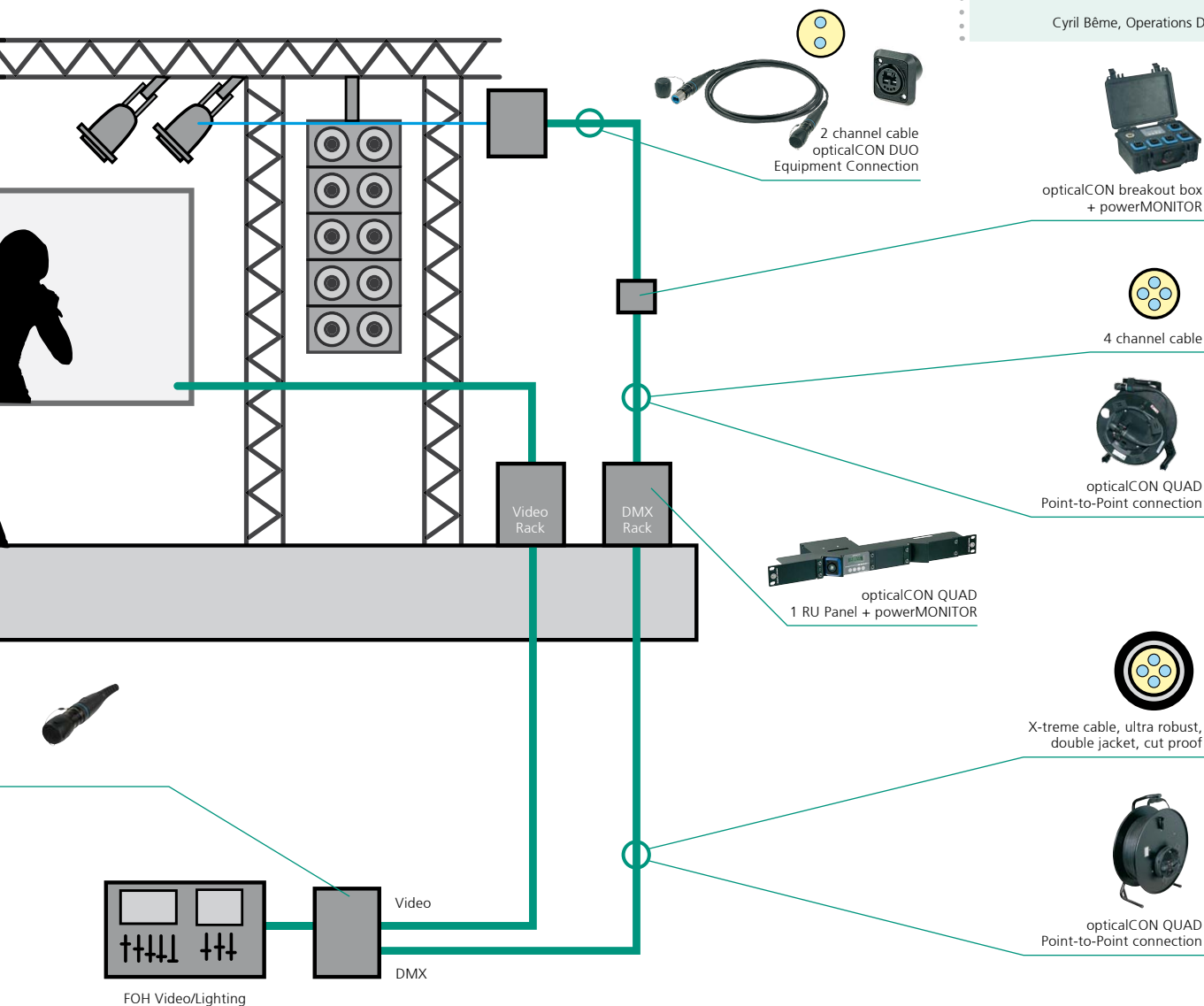

Applications

Broadcast - OB Truck

TPC, SWITZERLAND

The TPC (TV productioncenter zürich ag) has standardized the opticalCON QUAD for mobile outdoor fiber optic connectivity. The system has been applied for all fiber optic point-to-point routing applications, no matter what type of signal is required.

The provided fiber services include:

- Camera signals
- Video signal (monitors, displays, wall-displays)
- Audio networking
- Intercom
- Data (Ethernet, RS422, RS232)
- Broadcast signal distribution

With the standardization of the opticalCON the fiber optic point-to-point connectivity is nationwide compatible on I/O panels of OB-trucks, SNG-trucks, stadiums or national broadcast signal distribution boxes.

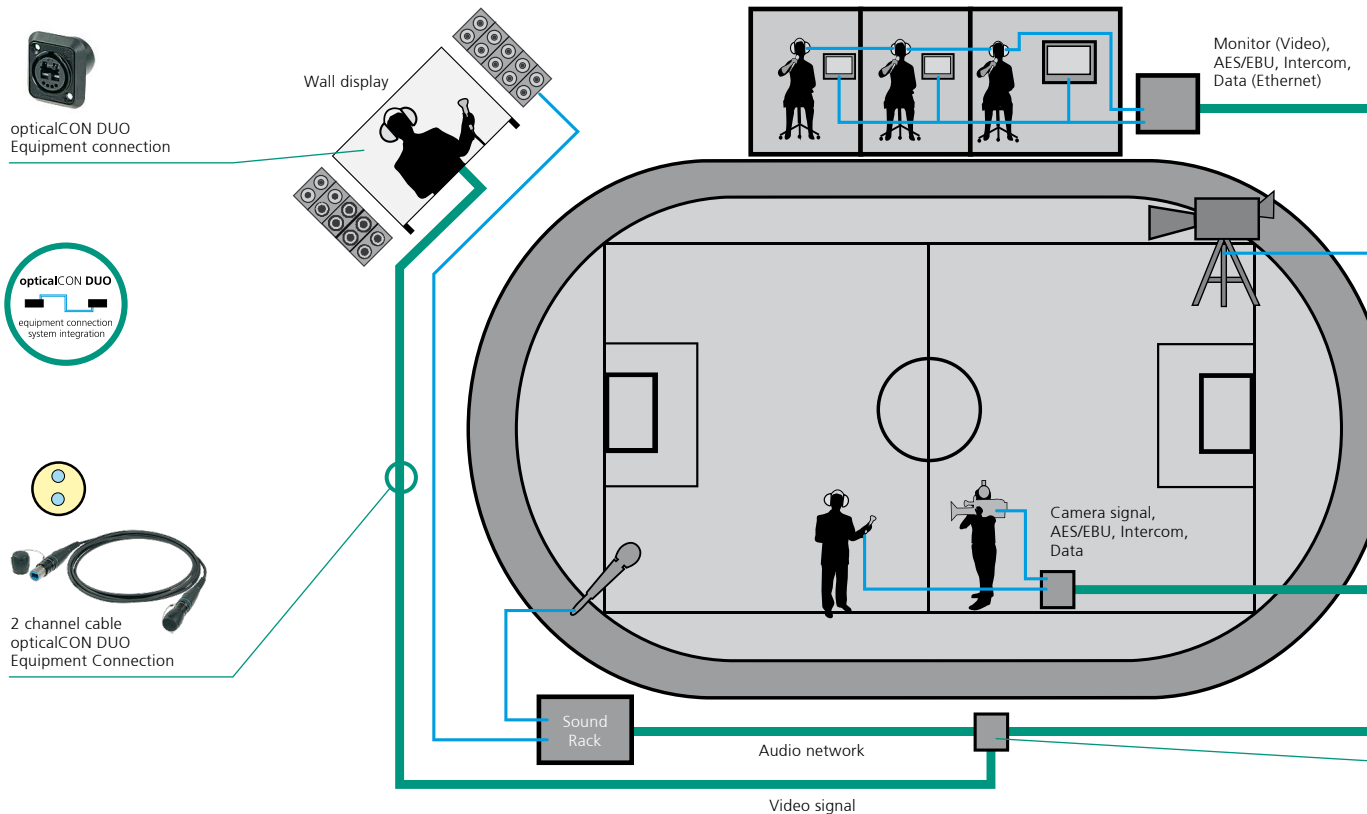
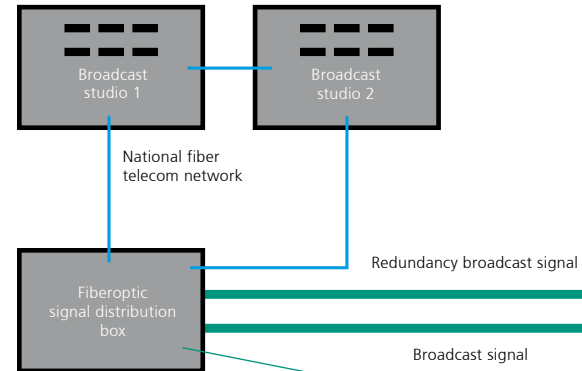

Depending to the size of the required installation, the setup team has the choice between 12 or 4 channel cables which are both based on the opticalCON QUAD connection system. The same cable can be used no matter if big stadium events, outdoor events (e.g. ski races) or SNG/ENG applications are required. Each channel can be in-dividually patched to the required equipment for the specific job.

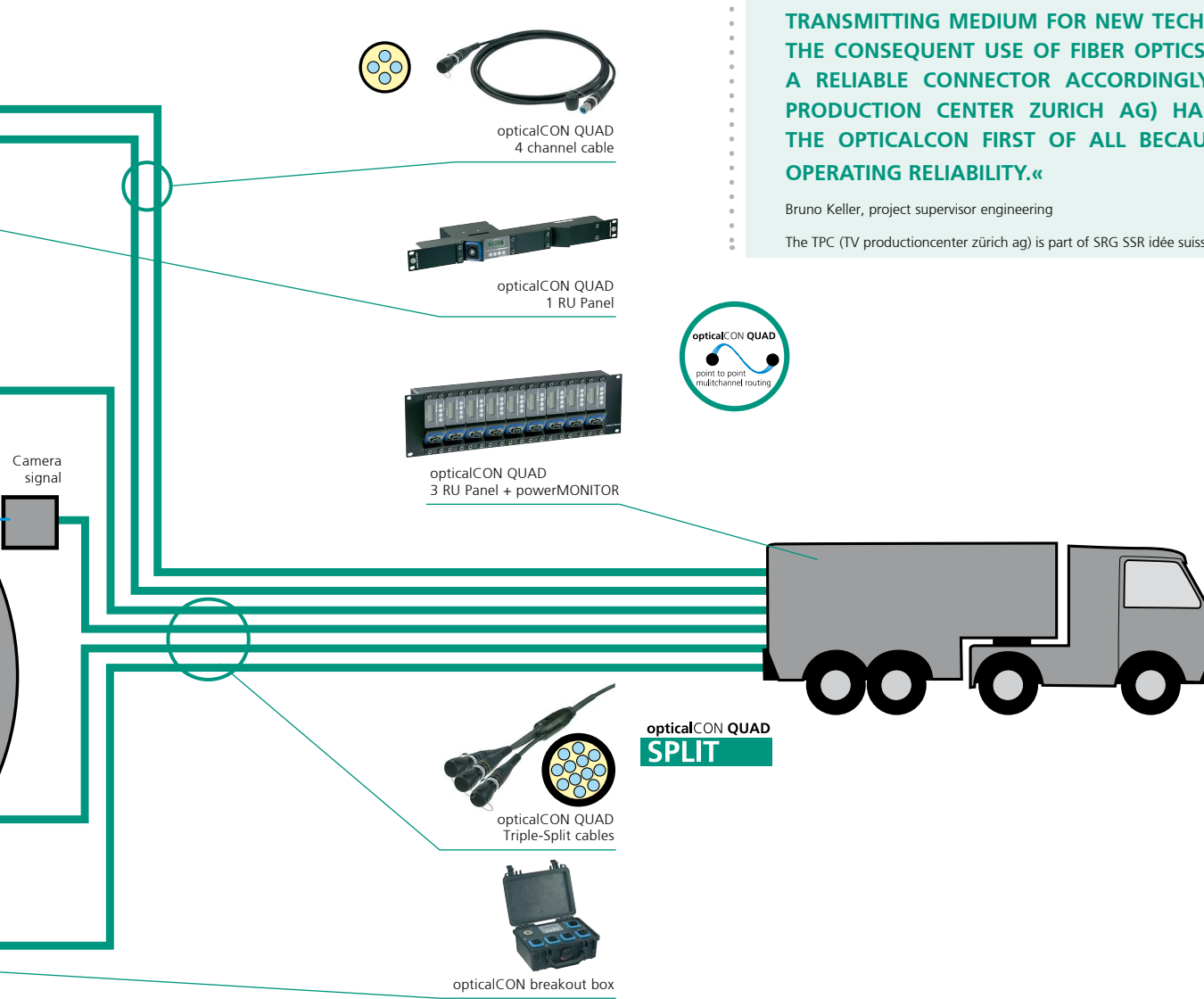

»NEW EQUIPMENT AND NEW TECHNOLOGIES LIKE FOR EXAMPLE HDTV, ASK FOR INCREASING DATA TRANSMISSION RATES, WHICH CAN HARDLY BE REALIZED WITH COPPER CABLES ANY MORE. IN THIS REGARD FIBER OPTICS CAN BE CLASSIFIED AS THE PERFECT SUITABLE AND UP TO DATE TRANSMITTING MEDIUM FOR NEW TECHNOLOGIES. THE CONSEQUENT USE OF FIBER OPTICS REQUIRES A RELIABLE CONNECTOR ACCORDINGLY. TPC (TV PRODUCTION CENTER ZURICH AG) HAS CHOSEN THE OPTICALCON FIRST OF ALL BECAUSE OF ITS OPERATING RELIABILITY.«

Bruno Keller, project supervisor engineering

The TPC (TV productioncenter zürich ag) is part of SRG SSR idée suisse.

Applications

Broadcast - SNG/ENG

BORIS TV, UNITED KINGDOM

Boris TV uses Neutrik's opticalCON Low Voltage cable for series productions (e.g. at Twickenham Film Studios). The production requires frequent reconnection of links to cameras in a dusty environment, the shutters seal proved effective in preventing dust contamination of fibres.

The low voltage camera cable is a cost effective fiber optic hybrid cable solution and a great SMPTE cable alternative if

only low voltage is required. The ultra flexible and lightweight (65 kg/km) design is optimized for camera link systems (e.g. for ENG / SNG¹), camera adapter systems, camera cranes and powered drop down converter boxes for broadcast applications where only ELV² (< 50Vac) is required.

»A PARTICULAR BENEFIT TO BORIS TELEVISION LTD HAS BEEN THE ABILITY TO CARRY ENOUGH CABLE TO SUPPORT 8 CAMERAS WITH A RANGE OF 150 M EACH WITHOUT REQUIRING ADDITIONAL LOGISTICAL SUPPORT TO CARRY CABLE TO THE LOCATION, THE LIGHT WEIGHT BEING A FURTHER BENEFIT IN THE HEALTH AND SAFETY ASPECT OF CABLE HANDLING WHEN COMPARED WITH OTHER TRIAX OR SMPTE FIBRE SYSTEMS. THIS FEATURE HAS ALLOWED BORIS TV TO REDUCE ITS SET UP AND BREAKDOWN CREW REQUIREMENT.«

CJ Smith, Managing Director, Van Diemen Films Ltd

Boris TV is a multicamera OB and equipment hire business which is part of Van Diemen Films.

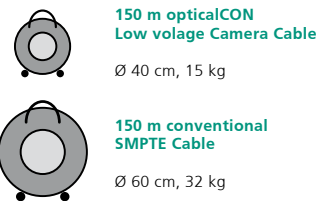

- 1) ... Electronic News Gathering / Satellite News Gathering
- 2) ... Extra Low Voltage

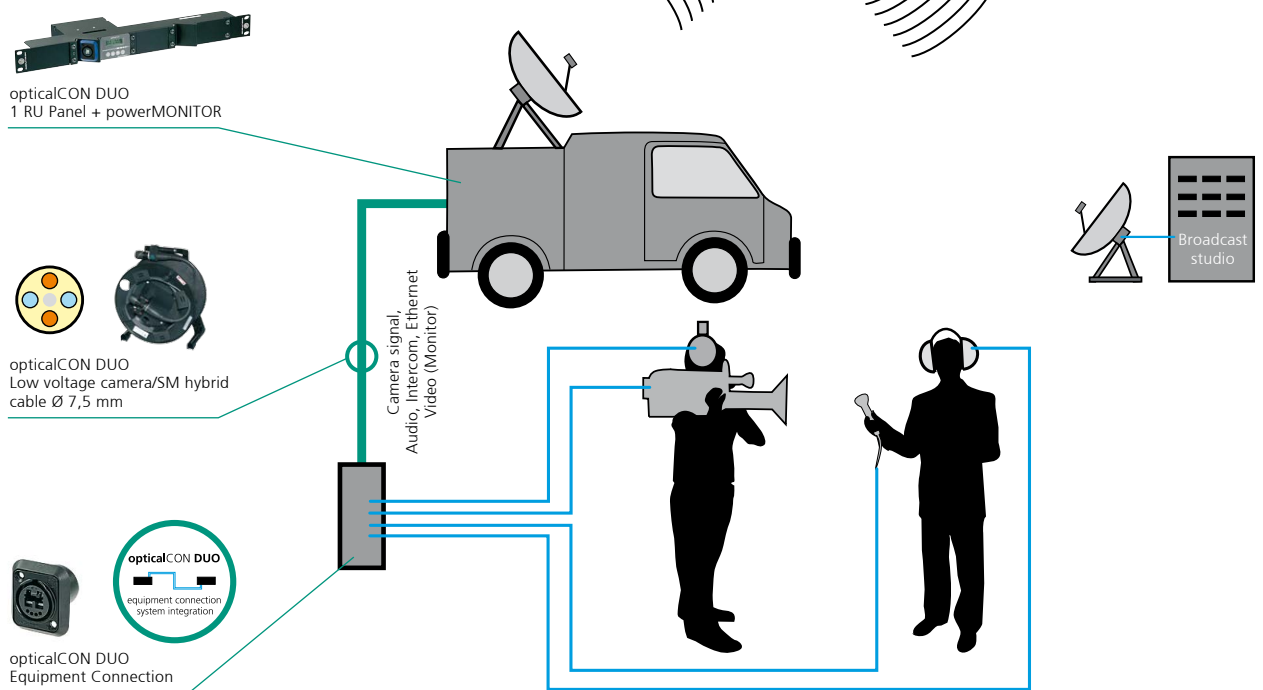

Broadcast - Studio Routing

opticalCON is the ideal solution for studio / OB-van patch rack applications. The system's sealing shutters ensure high mating cycles and minimized maintenance.

Typically used in high quantities, opticalCON chassis connectors are simple to install and very cost effective compared to other robust fiber optic connection systems. In particular, the opticalCON DUO chassis connector is well suited for system integrations, as it offers LC compatibility on both front and

rear. With its four copper contacts, opticalCON DUO can be used both with cost-effective permanent LC patch cables and also for hybrid powered connections to broadcast cameras.

Boris TV uses the opticalCON DUO system with Low Voltage cables (e.g. at Desmet Studios in Amsterdam) for its frequent reconfigurations of camera and cable setups between studios. The system has proven to be effective and reliable.

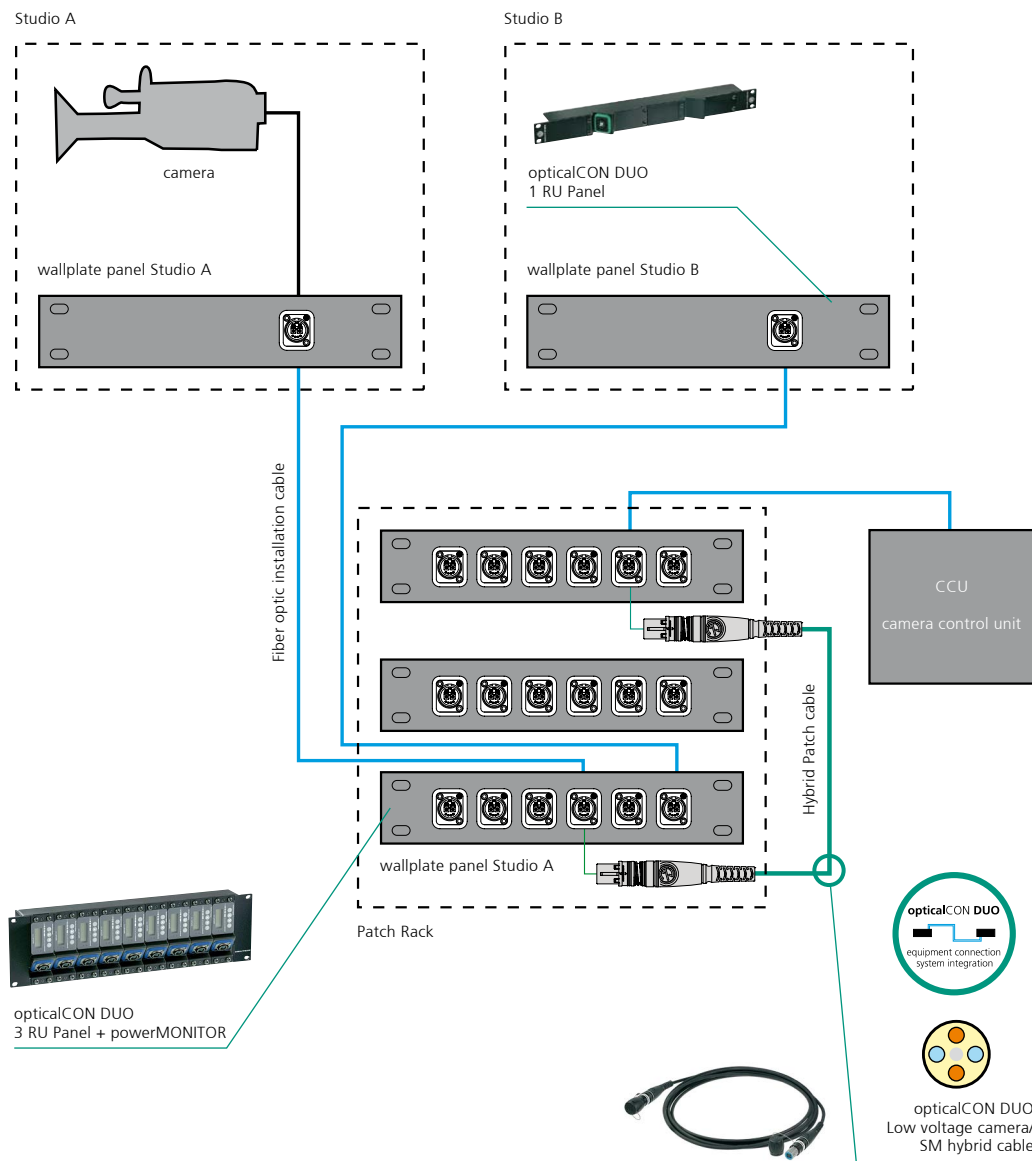

Wiring And Hook Up Suggestion

opticalCON DUO Or QUAD?

The opticalCON connection system offers high flexibility. The front and rear LC compatibility of the 2-channel opticalCON DUO makes the system ideal for equipment connections and system integration. The 4-channel opticalCON QUAD is focused on mobile, multichannel point-to-point connections.

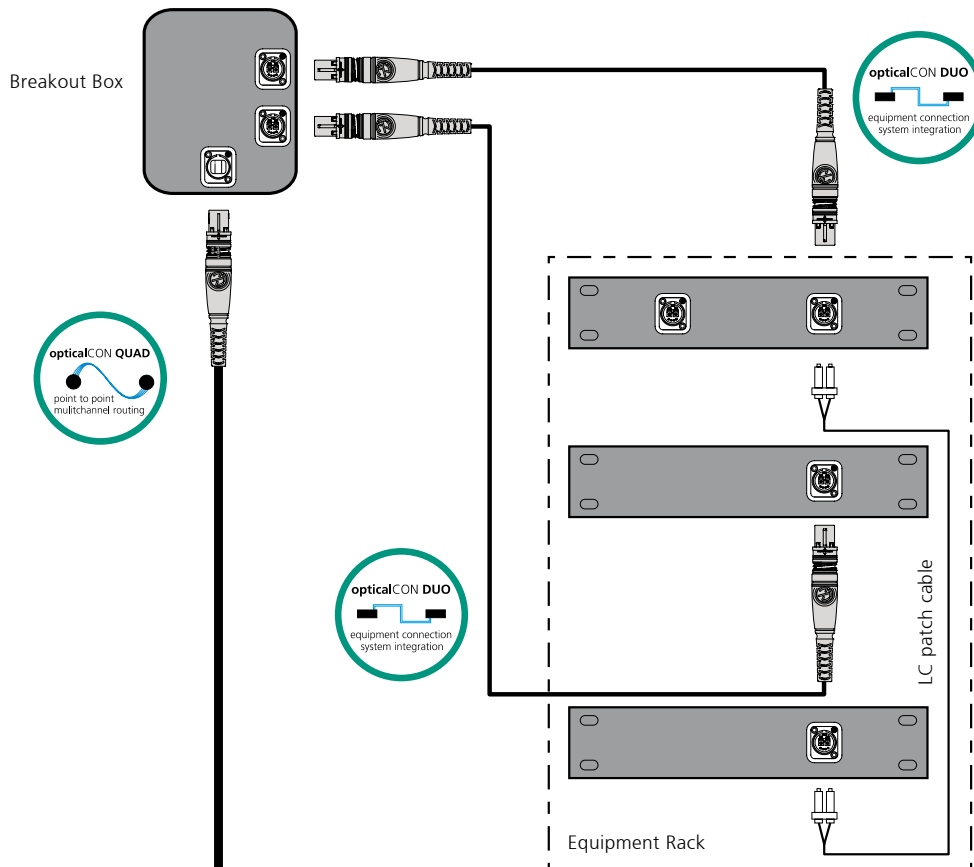

Cable Wiring

Fiber

In order to achieve uniform and compatible systems, Neutrik recommends following the wiring suggestions of the ISO / IEC 11801 which define channel A (right) as input and channel B (left) as output.



Copper

SMPTE WIRING

For studio camera wiring, Neutrik recommends following the SMPTE wiring suggestion:

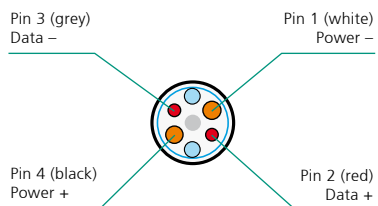

Low Voltage

For ELV (Extra Low Voltage) applications (< 50 V) Neutrik recommends the following wiring.

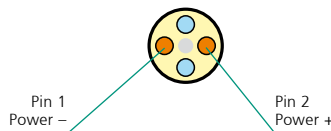

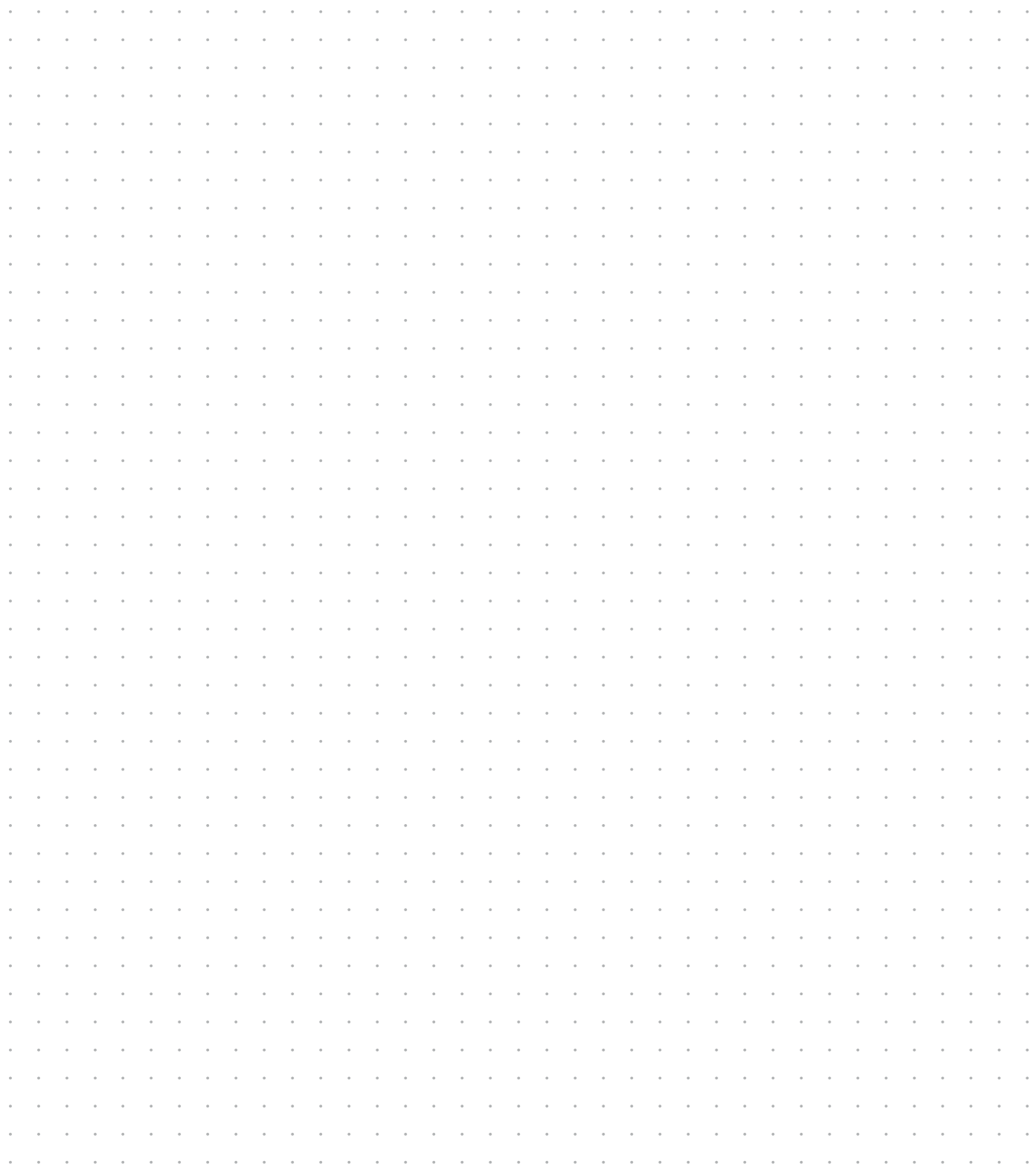



NEUTRIK®, crystalCON®, etherCON®, maxCON®, miniCON®, nanoCON®, neutriCON®, opticalCON®, powerCON®, Profi®, rearTWIST®, silentPLUG®, speakON®, DIWA®, XIRIUM®, are registered trademarks of Neutrik AG.



Liechtenstein (Headquarters)

NEUTRIK AG, Im alten Riet 143, 9494 Schaan
T +423 237 24 24, F +423 232 53 93, neutrik@neutrik.com

Germany / Netherlands / Denmark / Austria

Neutrik Vertriebs GmbH, Felix-Wankel-Strasse 1, 85221 Dachau, Germany
T +49 8131 28 08 90, info@neutrik.de

Great Britain

Neutrik (UK) Ltd., Westridge Business Park, Cothey Way
Ryde, Isle of Wight PO33 1 QT
T +44 1983 811 441, sales@neutrik.co.uk

France

Neutrik France SARL, Rue du Parchamp 13, 92100 Boulogne-Billancourt
T +33 1 41 31 67 50, info@neutrik.fr

USA

Neutrik USA Inc., 4115 Taggart Creek Road, Charlotte, North Carolina, 28208
T +1 704 972 30 50, info@neutrikusa.com

Japan

Neutrik Limited, Yusen-Higashinohonbashi-Ekimaie Bldg., 3-7-19
Higashinohonbashi, Chuo-ku, Tokyo 103
T +81 3 3663 47 33, mail@neutrik.co.jp

Hong Kong

Neutrik Hong Kong LTD., Suite 18, 7th Floor Shatin Galleria
Fotan, Shatin
T +852 2687 6055, neutrik@neutrik.com.hk

China

Ningbo Neutrik Trading Co., Ltd., Shiqi Street, Yinxian Road West
Fengjia Villiage, Yinzhou Area, Ningbo, Zhejiang, 315153
T +86 574 88250488 800, neutrik@neutrik.com.cn

India

Neutrik India Pvt. Ltd., Level 3, Neo Vikram, New Link Road,
Above Audi Show Room, Andheri West, Mumbai, 400058
T +91 982 05 43 424, anklesaria@neutrik.com

Associated companies

Contrik AG

Steinackerstrasse 35, 8902 Urdorf, Switzerland
T +41 44 736 50 10, contrik@contrik.ch

H. Adam GmbH

Felix-Wankel-Straße 1, 85221 Dachau, Germany
T +49 08131 28 08-0, info@adam-gmbh.de

