

RackLink™

power management system

RackLink™ Series products ensure system reliability and system uptime, providing intuitive setup and operation, pre-emptive problem notification and automatic problem resolution

features:

- Easy set up, with simple plug & play installation
- Monitor and log key environmental variables, including input voltage, load current and local temperature
- Tracks and provides instantaneous notification of anomalous voltage, load current and temperature conditions
- Detailed logging of environmental variables and alerts
- Auto Ping monitors remote IP devices and services and can automatically restart an unresponsive network device
- Proactive & automatic fault resolution
- Local control of individual outlets via manual switches
- Integrated web server for browser-based access and control of individual outlets and dry contact outputs
- Open-architecture serial communications protocol provides:
 - 100% cloud compliance, without cloud-dependence; and
 - Seamless integration into any RS-232 or TCP/IP based architecture
- All RackLink™ series products are fully compliant with any control system or content aggregator; drivers available now from select control system partners
- Extend control outside the rack to anywhere in the facility through dry contact outputs

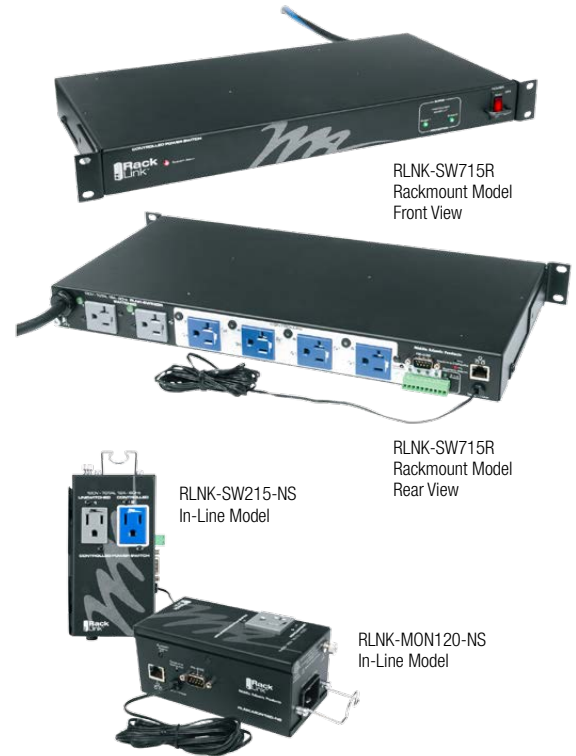

specifications:

RackLink™ Series power management products shall be Middle Atlantic Products model # RLNK-____ (refer to chart). RackLink power products shall be ____"H x ____"W x ____"D (refer to chart). RackLink shall have a ____ amp power capacity (refer to chart). RackLink shall provide ____ surge protection (Basic, 2-Stage with Status Notification, Series refer to chart). RackLink shall provide ____ total outlets, ____ of which shall be individually controllable. RackLink shall provide ____ total dry contact outputs, ____ of which shall be individually controllable. RackLink shall provide sequencing (refer to chart for applicable models). RackLink shall provide auto-shutdown in over or under voltage events with automatic recovery (refer to chart for applicable models). RackLink shall include a ____' SignalSafe™ power cord (refer to chart). RackLink power products shall monitor and log key environmental variables, including input voltage, load current and local temperature. RackLink shall monitor specific remote IP devices and services and shall automatically reboot an unresponsive network device. RackLink shall provide user-defined alert thresholds for input voltage, load current and local temperature and shall issue e-mail notification on any threshold breach and recovery condition. RackLink shall automatically power down, or power up equipment as required on over-temperature condition. RackLink shall allow local export of log files in CSV format, and shall allow log files to be extracted to 3rd party databases via IP or RS-232. RackLink shall include an integrated web server for browser-based access and control. RackLink shall utilize an open-architecture serial communications protocol that is cloud compliant without being cloud dependant, and provide an API for seamless integration into any RS-232 or IP based architecture. RackLink shall allow remote access and control via devices using the iOS and Android™ operating systems using mobile applications. RackLink shall be fully compliant with any control system or aggregator. RackLink shall extend control to anywhere in the facility through dry contacts. RackLink shall be constructed of phosphate pre-treated steel with a black powdercoat finish. RackLink shall be RoHS EU Directive 2002/95/EC compliant. RackLink shall be manufactured by an ISO 9001 registered company. RackLink shall be warrantied to be free from defects in materials and workmanship under normal use and conditions for a period of 3 years. Rackmount power strip shall be ETL Listed to UL standard 60950-1 in US and CSA Listed to CAN/CSA C22.2 #60950-1 in Canada.

Customizable specification clips available at middleatlantic.com



what great systems are built on.™

A Group brand | legrand

Middle Atlantic Products
middleatlantic.com | middleatlantic.com

RackLink™

basic dimensions

all dimensions in inches unless otherwise noted [all dimensions in brackets are in millimeters]

Part #	Form Factor	Max Load	Rated Load	Surge Protection	Sequencing	# of Outlets		Controlled Dry Contacts	Integrated Web Server
						Total	Controlled		
RLNK-MON115-NS	In-Line Module	15A	12A	Basic	No	1	0	0	Yes
RLNK-MON120-NS	In-Line Module	20A	16A	Basic	No	1	0	0	Yes
RLNK-SW215-NS	In-Line Module	15A	12A	Basic	No	2	1	1	Yes
RLNK-SW220-NS	In-Line Module	20A	16A	Basic	No	2	1	1	Yes
RLNK-SW715R	Rackmount	15A	12A	2-Stage	No	7	5	4	Yes
RLNK-SW715R-NS	Rackmount	15A	12A	Basic	No	7	5	5	Yes
RLNK-SW620R	Rackmount	20A	16A	2-Stage	No	6	4	4	Yes
RLNK-SW620R-NS	Rackmount	20A	16A	Basic	No	6	4	5	Yes
RLNK-SW415R-SP	Half-Rack	15A	12A	Series	Yes	4	4	2	Yes
RLNK-SW815R-SP	Rackmount	15A	12A	Series	Yes	8	8	2	Yes
RLNK-SW820R-SP	Rackmount	20A	16A	Series	Yes	8	8	2	Yes

AC Power	
Connection Type	(Rackmount Models) 9 ft. SignalSafe™ Cord (15A / 20A) (In-Line Models) 3 ft. SignalSafe™ IEC (15A / 20A)
Line Voltage	Nominal: 120VAC Minimum: 80VAC / Maximum: 140VAC
Maximum Peak Load	15A models: 15 Amps 20A models: 20 Amps
Maximum Cont. Load	15A models: 12 Amps 20A models: 16 Amps
Alert Threshold Range	
Input Voltage Alert	Low: 105VAC - 110VAC High: 123VAC - 128VAC
Load Current Alert	Minimum: 0A Maximum: 15A / 20A (15A models / 20A models)
Temperature Alert	Minimum: 0°F Maximum: 140°F
Basic and 2-Stage Surge Specification	
Peak Impulse Current	- 30,000 Amps, one time - 19,500 Amps, two times within 5 minutes - 7,000 Amps, ten times within 2 minutes - Max. peak impulse current pulse as defined between line and neutral - Maximum multiple impulse current derated per spec
Protection Mode	Line to Neutral only; no ground contamination
Response Time	Less than 1 nanosecond
Surge Energy Dissipation	711 Joules (10/ 00 micro sec.) (2-stage models) 160 Joules (-NS models)
EMI/RF Suppression	>20dB Calculated Line to Neutral - 100kHz to 1Mhz - based on nominal impedance

Listed to UL 60950-1 and CSA C22.2 No. 60950-1

Series Protection™ Specification US PATENT # 8,947,844	
Voltage Protection Rating	330 V (lowest possible rating)
Clamping Voltage	186 VPEAK (NOMINAL LINE VOLTAGE OF 132 VAC)
UL 1449 Adjunct Classification Test Results	1000 surges, 6000 volts, 3000 amps, B3 pulse. Measured suppressed voltage: 170 volts, no failures
EMI/RFI Filter, Normal Mode (50-ohm load)	40 dB @ 100 kHz; 50 dB @ 300 kHz; 50 dB @ 3 MHz; 50 dB @ 30 MHz
EMI/RFI Filter, Common Mode (50-ohm load)	18 dB @ 300 kHz; 30 dB @ 1 MHz; 50 dB @ 5 MHz; 50 dB @ 20 MHz
Maximum Applied Surge Voltage	6000 volts*
Maximum Applied Surge Current	Unlimited, due to current limiting*
Maximum Applied Surge Energy	Unlimited, due to current limiting*
Endurance (C62.41-1991 Category B3 pulses)	3 kV>10,000; 6 kV >1000

*1.2 x 50 µs pulse, industry standard combination wave surge, as per IEEE C62.41

Event Driven/Responses	
AutoPing No Response/Recovery	Email and/or Control Outlet and/or Dry Contact/Sequence
Over/Under Temperature	Email and/or Control Outlet and/or Dry Contact
Over/Under Input Voltage	Email, and Automatic Shutdown/Recovery
Over/Under Load Current	Email
Operation Temperature Range	32 - 140°F (0-60°C)
Max Thermistor Operating & Measurement Temp	0-302°F (150°C)
Humidity Range	0-95% RH, non-condensing thermistor
Communication	RS-232 TCP/IP HTTP (integrated web server)
Dimensions	Rackmount Models: W 19.25" L 9" H 1.75" In-Line Models: 6" x 3" x 2.5" (can be mounted in any orientation)
Warranty	Series Protection™ Models: 12 years limited warranty Basic and 2-Stage Surge Models: 3 years limited warranty

what great systems are built on.™

RackLink™

rackmount basic dimensions

all dimensions in inches unless otherwise noted [all dimensions in brackets are in millimeters]

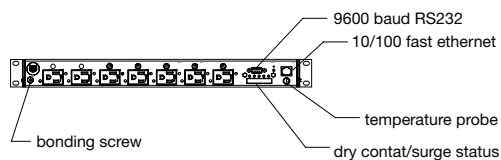
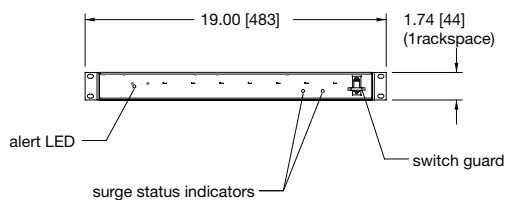
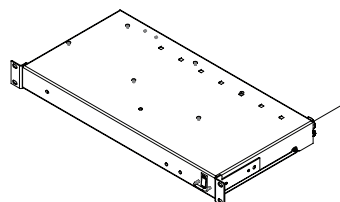
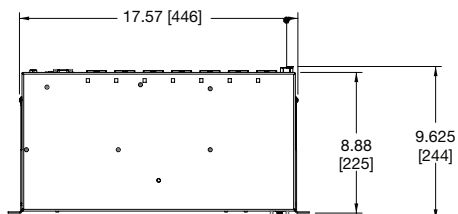

what **great systems** are built on.™

RackLink™

in-line module basic dimensions

all dimensions in inches unless otherwise noted [all dimensions in brackets are in millimeters]

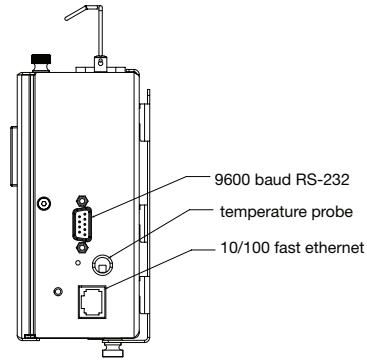
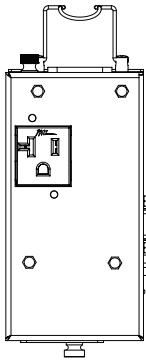
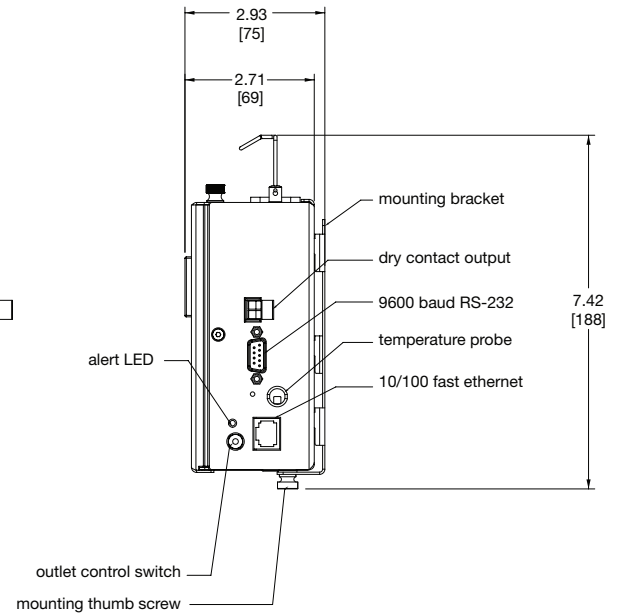
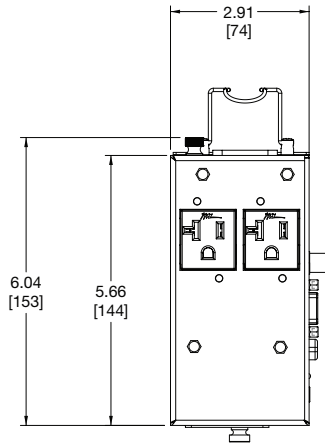
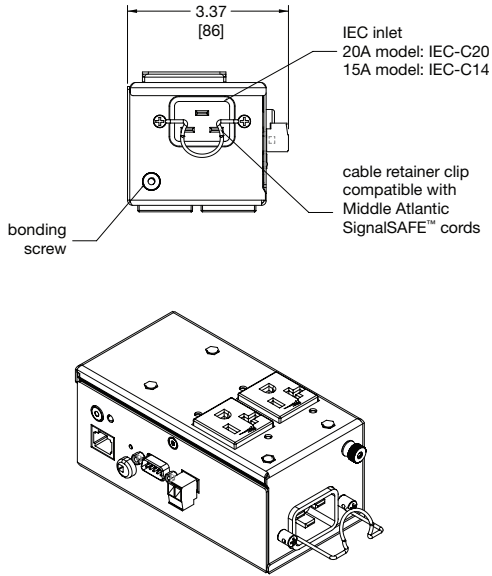

what **great systems** are built on.™

RackLink™

half rack basic dimensions

all dimensions in inches unless otherwise noted [all dimensions in brackets are in millimeters]

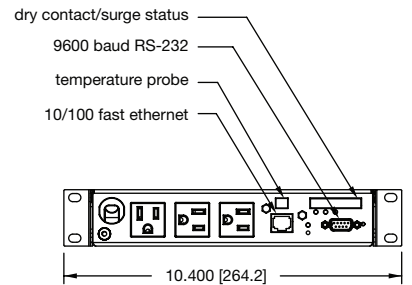
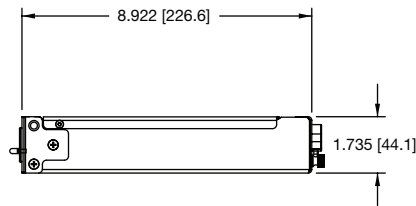
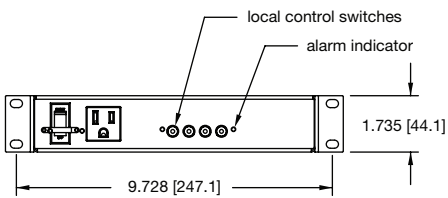
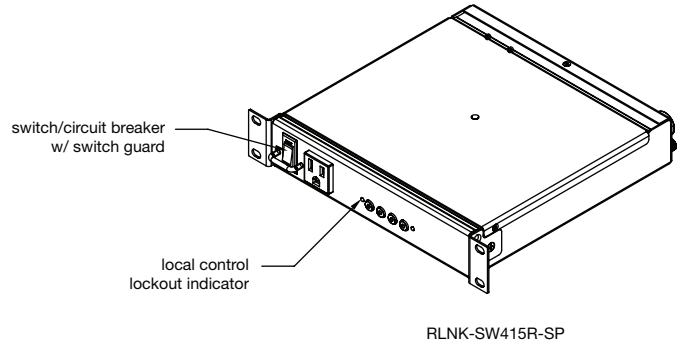
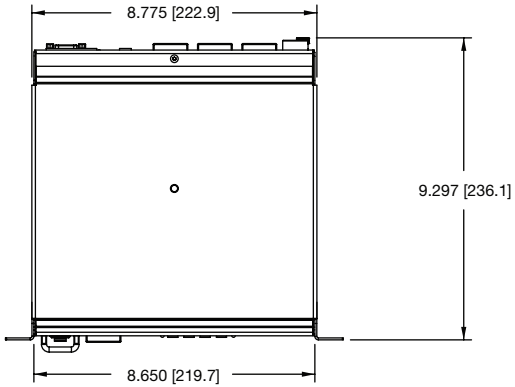

what **great systems** are built on.™

A Group brand | **legrand**

Middle Atlantic Products

middleatlantic.com | middleatlantic.ca

RackLink™

rackmount w/ Series Protection™ basic dimensions

all dimensions in inches unless otherwise noted [all dimensions in brackets are in millimeters]

US PATENT # 8,947,844

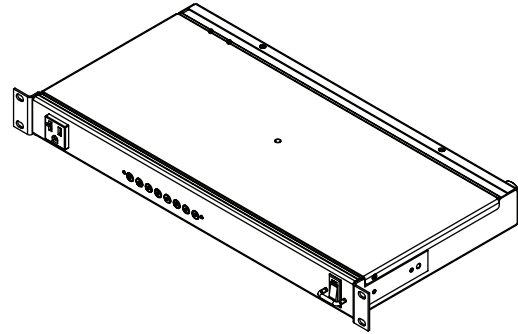
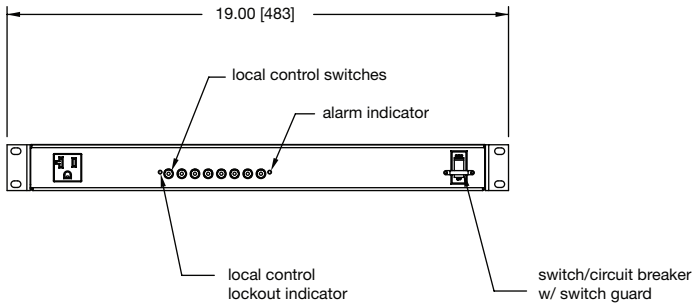

RLNK-SW820R-SP

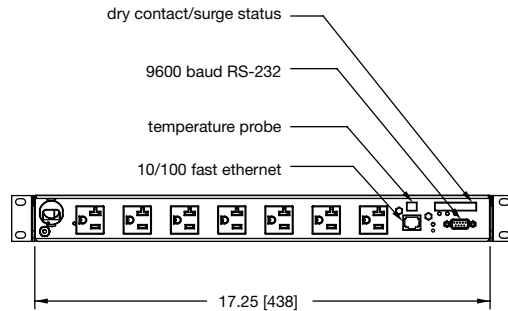
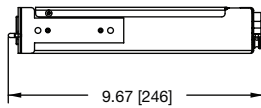

what **great systems** are built on.™

A Group brand | **legrand**



Middle Atlantic Products
middleatlantic.com | middleatlantic.ca