

Enclosure Systems  
Power Distribution  
Thermal Management  
Cable Management  
Custom Rackmounts  
Rack Accessories  
Technical Furniture

2008 - 2009 MASTER CATALOG



EXCEPTIONAL SUPPORT & PROTECTION PRODUCTS

  
Middle Atlantic Products, Inc.

2008 - 2009 MASTER CATALOG

Middle Atlantic Products, Inc. 2008 - 2009 Master Catalog



# Alpha-Numeric Index

|             |         |               |            |             |              |             |          |            |         |
|-------------|---------|---------------|------------|-------------|--------------|-------------|----------|------------|---------|
| 2-x         | 35      | DRIFT         | 28         | JMS-12X6    | 73           | RIB-x       | 26       | TA         | 120     |
| 23-19-x     | 13      | DRK-x         | 12         | KB-SS       | 119          | RKx         | 34       | TBIT       | 132     |
| 5-x         | 32      | DT8x          | 101-102    | KDB-x       | 125          | RKW         | 34       | TCD        | 120     |
| 5CCx        | 33      | DUCT-COOL-xPT | 87         | KDEx        | 125          | RLx         | 58       | TDx        | 121     |
| 5W          | 33      | DVD           | 120        | K-DEC       | 75           | RLA-x       | 59       | TEMP-DEC   | 85      |
| 5WL         | 33      | DVDP          | 121        | KO-x        | 85           | RLM-x       | 74       | TFPx       | 82      |
| ACC-KEY     | 29      | DVHSP         | 121        | KYLK        | 121          | RM-KB       | 119      | THERM-A    | 87      |
| AFACE       | 117     | DWR-x         | 40         | LACE        | 31, 111      | RM-KB-LCDx  | 118      | TOR-x      | 46      |
| ANGLE-x     | 26      | DWR-RRx       | 39, 41, 43 | LATCH       | 29, 121      | RPS         | 79       | TSP-5-x    | 33      |
| AP-x        | 126     | DWRSR-ZL      | 39, 41     | LBx         | 107-110      | RRFx        | 133      | TRACKL     | 49      |
| AS3-x       | 122     | EBx           | 130        | LBX-x       | 121          | RSH4x       | 116, 119 | TRACKx     | 49, 50  |
| ASP-OWP     | 31,111  | EC-x          | 126        | LD-x        | 88-89        | RULER       | 133      | TSx        | 50      |
| ASR-x       | 54-55   | EC-SPK36      | 103        | LD-AM1X1    | 36           | Sx          | 127      | TS         | 120     |
| AXS         | 50      | EDLx          | 101        | LF          | 31           | S12x        | 101      | TSW-15     | 112     |
| AXS-FAN     | 82      | EDSx          | 101        | LG          | 28           | S12Dx       | 101      | TVHS       | 120     |
| AX-SXR      | 50      | ELx           | 101        | LP          | 120          | S12SDx      | 101      | TW12       | 112     |
| AX-SX       | 50      | ELURx         | 101        | LT-x        | 78-79        | S24Dx       | 101      | Ux         | 124     |
| AXS-TEXTRIM | 49      | ERK-x         | 24-25      | LVFD-x      | 29           | SAX         | 50       | U2MS       | 124     |
| BB-x        | 31      | ERK-xAXS      | 49         | M-x         | 74           | SBx         | 130      | U317       | 124     |
| BG17        | 51,52   | ERK-Z4        | 30         | MAG-1/2     | 28           | SBX-x       | 47       | UCPx       | 128-129 |
| BLx         | 130     | ESx           | 101        | MBRK        | 42           | SBIT        | 132      | UDx        | 121     |
| BMF-FAN10   | 82      | ESURx         | 101        | MD-KB       | 103          | SC3T-x      | 93       | UNI-x      | 126     |
| BRx         | 112     | EVTx          | 131        | MDV-x       | 104-105      | SC-x        | 92       | UP1        | 112     |
| BRKx        | 34      | EWR-x         | 42         | MK-x        | 59           | SC-Z4       | 30       | UQFP-x     | 83      |
| BS-MRK-x    | 30      | FAN           | 82         | MPR-x       | 71-75        | SCFD-x      | 95       | USC-x      | 73      |
| BS-WRK-x    | 30      | FANCORD-x     | 82         | MRK-x       | 18-19        | SCQ-x       | 90       | UTR1       | 124     |
| -C          | 117     | FC-x          | 84         | MRK-xAXS    | 49           | SCQRK-x     | 94       | VBK-x      | 85      |
| CAB-COOL    | 87      | FD-x          | 29         | MRK-TEMP-x  | 30           | SCRK-x      | 94       | VCD-x      | 57-58   |
| CAPx        | 123     | FEBx          | 130        | MRK-Z4      | 30           | SCW45-x     | 91, 93   | VDS        | 122     |
| CBS-5       | 33      | FI-x          | 121        | MW-x        | 28, 84       | S-DEC       | 75       | VFD-x      | 29      |
| CBS-x       | 30      | FILTER        | 82         | MV-PVTx     | 28           | SECL-x      | 127      | VFEET-x-12 | 26      |
| CC-44-x     | 17, 21  | FKx           | 128        | OBRKx       | 34           | SFx         | 127      | VHS        | 120     |
| CD          | 120     | FPx           | 82         | OCAP-x      | 123          | SFACE       | 119      | VLBX       | 45      |
| CFACE       | 117     | FWS           | 125        | OSRx        | 35           | SFD-KEY     | 29       | VMRK-54    | 22      |
| CHx         | 126     | G-8X10        | 73         | Px-CLN      | 133          | SFR-x       | 60       | VRK-x      | 20      |
| CK-45x      | 59      | GANG-10       | 28         | PB-x        | 69           | SGR-x       | 60       | VRK-Z4     | 30      |
| CL-GK       | 115     | GKx           | 112        | PBL-x       | 130          | SH-x        | 124      | VRR-54     | 23      |
| CLAW        | 103     | GR-30         | 112        | PCR-x       | 75           | SH-BRK      | 35       | VSA-x      | 122     |
| CLB-x       | 114-115 | GUARD         | 82         | PD-x        | 67-68, 76-77 | SL-x        | 127      | VSDR-x     | 127     |
| CLH-x       | 114-115 | GY            | 28         | PDS-x       | 77           | SONY EARS   | 133      | VTx        | 131     |
| CLS-COOLx   | 87      | HBLx          | 130        | PDT-x       | 66           | SP-5-x      | 33       | VTB-x      | 131     |
| CM-x        | 103     | HCM-x         | 113        | PF-SS       | 103          | SPBIT       | 132      | VTFx       | 131     |
| CNx         | 132     | HCT-x         | 112        | PFD-x       | 29           | SPM-x       | 63       | VTP-x      | 131     |
| COMP-COOL   | 86      | HDR-x         | 62         | PHBL-x      | 130          | SPN-x       | 28, 57   | WANGLE-x   | 26      |
| CRATE       | 30      | HHCM-x        | 113        | PPM-x       | 61           | SPN3T-x     | 93       | WL-60      | 78      |
| CSB         | 58      | HPx           | 132        | PROMRK-RRx  | 19           | SPNQx       | 91       | WM-x       | 63      |
| Dx          | 121     | HPM-x         | 61         | PROR4CN-RRx | 57           | SR-x        | 38       | WMRK-x     | 10      |
| D12x        | 101     | HS            | 132        | PROWRK-RRx  | 17           | SRB-x-MRK-x | 27       | WMS-20     | 125     |
| DANGLE      | 26      | HSK           | 132        | PSDR-x      | 127          | SR-SUB      | 39       | WR-x       | 48      |
| DARULER     | 133     | HTX           | 132        | PTRK-x      | 37           | SRCC        | 52       | WRINKLE    | 28      |
| DCDP        | 121     | HWx           | 132        | PUT         | 28           | SRD-KEY     | 29       | WRK-x      | 16      |
| DCS         | 29      | ICAB-COOL     | 87         | PVFD-x      | 29           | SRK         | 35       | WRK-24MDK  | 37      |
| DECP-1x     | 126     | ICLS-COOL     | 87         | QFAN        | 82           | SRSx        | 52       | WRK-xAXS   | 49      |
| DLBX        | 45      | ICOMP-COOL    | 86         | QFP-x       | 82           | SRSR-x      | 52       | WRK-xSA-x  | 14      |
| DM          | 121     | IDF-x         | 44         | QTFP-x      | 82           | SS          | 123      | WRK-TEMP-x | 30      |
| DO-5-x      | 33      | IEC-x         | 65         | R4x         | 56-57        | SSAX        | 50       | WRK-Z4     | 30      |
| DOC         | 29      | ISO-1         | 31         | RAPx        | 33           | SSDR-x      | 127      | WRP-x      | 47      |
| DOP-5-x     | 33      | ISO-KOP       | 31         | RBA-x       | 30           | SSL         | 123      | WRS-x      | 47      |
| D-PTxx      | 89      | ISRK          | 36         | RC-x        | 123          | STxMP       | 133      | WSx        | 27      |
| DR-x        | 35      | J-x           | 73         | REBx        | 55           | SW          | 132      | WUSSx      | 125     |
| D-RING      | 113     | JDC-12X18     | 85, 115    | RH-x        | 133          | T-x         | 73       |            |         |



# Table Of Contents

## Finishes

|   |   |
|---|---|
|    | black brushed and anodized (panels and accessories)   |
|    | silver brushed and anodized (panels and accessories)  |
|    | black textured powder coat (cabinets, cabinet options)  |
|    | black textured powder coat (panels and accessories)   |
|    | black powder coat (rackshelves, panels, etc.)   |
|    | granite gray textured powder coat (monitoring consoles, DWR)                                    |
|    | light gray textured powder coat (monitoring consoles)   |
|   | putty textured powder coat (WRP, HDR, TOR)  |
|  | pepperstone thermolaminate (Slim 5 - tops only, LCD Monitoring Desks - tops only, Edit Center™) |
|  | slate thermolaminate (LCD Monitoring Desks - sides only, Slim 5 - sides only)                   |
|  | honey maple thermolaminate (Edit Center™, LCD Monitoring Desks)                                 |
|  | dark cherry thermolaminate (Edit Center™, LCD Monitoring Desks, Slim 5 sides and tops)          |
|  | maple thermolaminate (Slim 5 - sides and tops, MBRK Racks)                                      |
|  | light walnut thermolaminate (Slim 5 - sides and tops)   |
|  | black wood grain laminate (Slim 2, RK, BRK Series & Edit Center™ Series racks)                  |
|  | oak laminate (OBRK, OSR Racks)  |
|  | graphite desktop laminate MultiDesk Video™, console work surfaces)                              |

## Categories



### Racks and Enclosures

|                                       | Pgs.  |
|---------------------------------------|-------|
| Rack and Enclosure Options            | 4-5   |
| Where to Use Middle Atlantic Products | 6     |
| New From Middle Atlantic Products     | 7     |
| The Power of the Integrated System    | 8-9   |
| Floor Standing Racks and Enclosures   | 10-27 |
| Universal Enclosure Options           | 28-31 |
| Slim 5 Equipment Racks                | 32-33 |
| Laminate Racks                        | 34-35 |
| Portable Racks                        | 36-37 |
| Pivoting Rack                         | 38-39 |
| Wall Mount and Truss Mount Racks      | 40-48 |
| Slide Out Racks                       | 49-55 |
| Open Frame Racks                      | 56-59 |
| Wall Mount Racks                      | 60-63 |

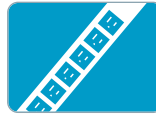

### Power Distribution and Lighting

|  | Pgs.  |
|--|-------|
| Power Best Practices                               | 64    |
| IEC Power Cords                                    | 65    |
| Vertical Power Products                            | 66-69 |
| Modular Power Raceway System                       | 70-75 |
| Rackmount Power, Lighting and Remote Power Control | 76-79 |



### Thermal Management

|                                   | Pgs.  |
|-----------------------------------|-------|
| Thermal Management Best Practices | 80-81 |
| Thermal Management Products       | 82-87 |

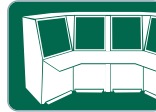

### Technical Furniture

|  | Pgs.    |
|--|---------|
| LCD Monitoring/Command Desk                | 88-89   |
| Quiet-Cool Series™ Consoles                | 90-91   |
| Convective Series™ Consoles                | 92-93   |
| Floor Standing Enclosures                  | 94-95   |
| Work Surface/Ordering Guide/Configurations | 96-99   |
| Edit Center™                               | 100-103 |
| MultiDesk Video™                           | 104-105 |



### Cable Management

|   | Pgs.    |
|---|---------|
| Cable Management Best Practices/Accessories | 106-113 |
| Cable Ladders                               | 114-115 |

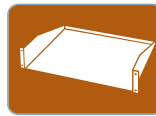

### Rack Accessories

|   | Pgs.    |
|---|---------|
| RSH Series Custom Rackmounts                          | 116-117 |
| Computer Products                                     | 118-119 |
| Rackmount Storage                                     | 120-121 |
| Rackshelves   | 122-125 |
| Universal Panels, Rackmount Chassis and Access Panels | 126     |
| Security Covers                                       | 127     |
| Modular Custom Panel Systems                          | 128-129 |
| Blank Panels  | 130     |
| Vent Panels   | 131     |
| Rack Screws   | 132     |
| Rack Accessories                                      | 133     |



### Resources

|           | Pgs. |
|-----------|------|
| Resources | 134  |
| Glossary  | 135  |



# Rack and Enclosure Options

| RACK MODEL         | FRONT DOORS       |          |               |                        | STEEL SIDE PANELS | RECOMMENDED VERTICAL POWER STRIP | VENTED TOP | SOLID TOP | FAN TOP                    | SKIRTED WHEELBASE       | ADDITIONAL RACKRAIL | RACKING HEIGHT | OVERALL HEIGHT | USEABLE DEPTH   | OVERALL DEPTH   | OVERALL WIDTH | PG. # |
|--------------------|-------------------|----------|---------------|------------------------|-------------------|----------------------------------|------------|-----------|----------------------------|-------------------------|---------------------|----------------|----------------|-----------------|-----------------|---------------|-------|
|                    | SOLID             | PLEXI    | 22% OPEN AREA | 64% OPEN AREA          |                   |                                  |            |           |                            |                         |                     |                |                |                 |                 |               |       |
| 5-8                | DO-5-8            | DOP-5-8  |               |                        | SP-5-8            | <b>C</b> ●                       |            |           |                            | CBS-5, CBS-5R           | SAR8                | 14" (8 SP)     | 17.75"         | 19.875"         | 20"             | 19.125"       | 32    |
| 5-14               | DO-5-14           | DOP-5-14 |               |                        | SP-5-14           | <b>C</b> ■                       |            |           |                            | CBS-5, CBS-5R           | SAR14               | 24.5" (14 SP)  | 28.25"         | 19.875"         | 20"             | 19.125"       | 32    |
| 5-21               | DO-5-21           | DOP-5-21 |               |                        | SP-5-21           | <b>E G</b> ■                     |            |           |                            | CBS-5, CBS-5R           | SAR21               | 36.75" (21 SP) | 40.5"          | 19.875"         | 20"             | 19.125"       | 32    |
| 5-29               | DO-5-29           | DOP-5-29 |               |                        | SP-5-29           | <b>E G J</b> ■                   |            |           |                            | CBS-5, CBS-5R           | SAR29               | 50.75" (29 SP) | 54.5"          | 19.875"         | 20"             | 19.125"       | 32    |
| 5-37               | DO-5-37           | DOP-5-37 |               |                        | SP-5-37           | <b>G J N</b> ■                   |            |           |                            | CBS-5, CBS-5R           | SAR37               | 64.75" (37 SP) | 68.5"          | 19.875"         | 20"             | 19.125"       | 32    |
| 5-43               | DO-5-43           | DOP-5-43 |               |                        | SP-5-43           | <b>N P T</b> ■                   |            |           |                            | CBS-5, CBS-5R           | SAR43               | 75.25" (43 SP) | 79"            | 19.875"         | 20"             | 19.125"       | 32    |
| 5-8-26             | DO-5-8            | DOP-5-8  |               |                        | SP-5-8-26         | <b>C</b> ●                       |            |           |                            | CBS-5-26, CBS-5-26R     | SAR8-26             | 14" (8 SP)     | 17.75"         | 25.875"         | 26"             | 19.125"       | 32    |
| 5-14-26            | DO-5-14           | DOP-5-14 |               |                        | SP-5-14-26        | <b>C</b> ■                       |            |           |                            | CBS-5-26, CBS-5-26R     | SAR14-26            | 24.5" (14 SP)  | 28.25"         | 25.875"         | 26"             | 19.125"       | 32    |
| 5-21-26            | DO-5-21           | DOP-5-21 |               |                        | SP-5-21-26        | <b>E G</b> ■                     |            |           |                            | CBS-5-26, CBS-5-26R     | SAR21-26            | 36.75" (21 SP) | 40.5"          | 25.875"         | 26"             | 19.125"       | 32    |
| 5-29-26            | DO-5-29           | DOP-5-29 |               |                        | SP-5-29-26        | <b>E G J</b> ■                   |            |           |                            | CBS-5-26, CBS-5-26R     | SAR29-26            | 50.75" (29 SP) | 54.5"          | 25.875"         | 26"             | 19.125"       | 32    |
| 5-37-26            | DO-5-37           | DOP-5-37 |               |                        | SP-5-37-26        | <b>G J N</b> ■                   |            |           |                            | CBS-5-26, CBS-5-26R     | SAR37-26            | 64.75" (37 SP) | 68.5"          | 25.875"         | 26"             | 19.125"       | 32    |
| 5-43-26            | DO-5-43           | DOP-5-43 |               |                        | SP-5-43-26        | <b>N P T</b> ■                   |            |           |                            | CBS-5-26, CBS-5-26R     | SAR43-26            | 75.25" (43 SP) | 79"            | 25.875"         | 26"             | 19.125"       | 32    |
| DRK19-44-31        | DPFD-44, DPVFD-44 | DVFD-44  |               |                        | SPN-44-312        | <b>N P R T</b>                   | MW-VT      | MW-ST     | MW-4FT, MW-6FT, MW-10FT    | CBS-DRK-31              | DRK19-RR44          | 77" (44 SP)    | 83.5"          | 24.25"          | 31.5"           | 30"           | 12    |
| DRK19-44-31PRO     | DPFD-44, DPVFD-44 | DVFD-44  |               |                        | SPN-44-312        | <b>N P R T</b>                   | MW-VT      | MW-ST     | MW-4FT, MW-6FT, MW-10FT    | CBS-DRK-31              | DRK19-RR44PRO       | 77" (44 SP)    | 83.5"          | 24.25"          | 31.5"           | 30"           | 12    |
| DRK19-44-36        | DPFD-44, DPVFD-44 | DVFD-44  |               |                        | SPN-44-36         | <b>N P R T</b>                   | MW-VT      | MW-ST     | MW-4FT, MW-6FT, MW-10FT    | CBS-DRK-36              | DRK19-RR44          | 77" (44 SP)    | 83.5"          | 28.75"          | 36"             | 30"           | 12    |
| DRK19-44-36PRO     | DPFD-44, DPVFD-44 | DVFD-44  |               |                        | SPN-44-36         | <b>N P R T</b>                   | MW-VT      | MW-ST     | MW-4FT, MW-6FT, MW-10FT    | CBS-DRK-36              | DRK19-RR44PRO       | 77" (44 SP)    | 83.5"          | 28.75"          | 36"             | 30"           | 12    |
| DRK19-44-42        | DPFD-44, DPVFD-44 | DVFD-44  |               |                        | SPN-44-423        | <b>N P R T</b>                   | MW-VT      | MW-ST     | MW-4FT, MW-6FT, MW-10FT    | CBS-DRK-36              | DRK19-RR44          | 77" (44 SP)    | 83.5"          | 34.75"          | 39.5"           | 30"           | 12    |
| DRK19-44-42PRO     | DPFD-44, DPVFD-44 | DVFD-44  |               |                        | SPN-44-423        | <b>N P R T</b>                   | MW-VT      | MW-ST     | MW-4FT, MW-6FT, MW-10FT    | CBS-DRK-36              | DRK19-RR44PRO       | 77" (44 SP)    | 83.5"          | 34.75"          | 39.5"           | 30"           | 12    |
| DRK23-44-31        | DPFD-44, DPVFD-44 | DVFD-44  |               |                        | SPN-44-312        | <b>N P R T</b>                   | MW-VT      | MW-ST     | MW-4FT, MW-6FT, MW-10FT    | CBS-DRK-31              | DRK23-RR44          | 77" (44 SP)    | 83.5"          | 28.25"          | 31.5"           | 30"           | 12    |
| DWR-10-17/22       | FD-10             | PFD-10   | VFD-10        | LVFD-10                |                   | <b>C</b> **                      |            |           |                            |                         | DWR-RR10            | 17.5" (10 SP)  | 24.563"        | 15" / 20"       | 17" / 22"       | 23.4"         | 40    |
| DWR-12-17/22/26/32 | FD-12             | PFD-12   | VFD-12        | LVFD-12                |                   | <b>C</b> **                      |            |           |                            |                         | DWR-RR12            | 21" (12 SP)    | 28.063"        | 15" / 20" / 24" | 17" / 22" / 26" | 23.4"         | 40    |
| DWR-16-17/22       | FD-16             | PFD-16   | VFD-16        | LVFD-16                |                   | <b>C</b> **                      |            |           |                            |                         | DWR-RR16            | 28" (16 SP)    | 35.063"        | 15" / 20"       | 17" / 22"       | 23.4"         | 40    |
| DWR-18-17/22/26/32 | FD-18             | PFD-18   | VFD-18        | LVFD-18                |                   | <b>C</b> ** <b>E</b> ▼           |            |           |                            |                         | DWR-RR18            | 31.5" (18 SP)  | 38.563"        | 15" / 20" / 24" | 17" / 22" / 26" | 23.4"         | 40    |
| DWR-21-17/22       | FD-21             | PFD-21   | VFD-21        | LVFD-21                |                   | <b>C</b> ** <b>E G</b> ▼         |            |           |                            |                         | DWR-RR21            | 36.75" (21 SP) | 43.813"        | 15" / 20"       | 17" / 22"       | 23.4"         | 40    |
| DWR-24-17/22/26/32 | FD-24             | PFD-24   | VFD-24        | LVFD-24                |                   | <b>C</b> ** <b>E G J</b> ▼       |            |           |                            |                         | DWR-RR24            | 42" (24 SP)    | 49.063"        | 15" / 20" / 24" | 17" / 22" / 26" | 23.4"         | 40    |
| DWR-35-17/22/26    | FD-35             | PFD-35   | VFD-35        | LVFD-35                |                   | <b>C</b> ** <b>G J N</b> ▼       |            |           |                            |                         | DWR-RR35            | 61.25" (35 SP) | 68.313"        | 15" / 20" / 24" | 17" / 22" / 26" | 23.4"         | 40    |
| ERK-1820           | FD-18             | PFD-18   | VFD-18        | LVFD-18                |                   | <b>C E</b>                       |            |           |                            | CBS-ERK-20, CBS-ERK-20R | ERK-RR18            | 31.5" (18 SP)  | 35.625"        | 18.475"         | 20"             | 22"           | 24    |
| ERK-1825           | FD-18             | PFD-18   | VFD-18        | LVFD-18                |                   | <b>C E</b>                       |            |           |                            | CBS-ERK-25, CBS-ERK-25R | ERK-RR18            | 31.5" (18 SP)  | 35.625"        | 23.475"         | 25"             | 22"           | 24    |
| ERK-2120           | FD-21             | PFD-21   | VFD-21        | LVFD-21                |                   | <b>E G</b>                       |            |           |                            | CBS-ERK-20, CBS-ERK-20R | ERK-RR21            | 36.75" (21 SP) | 40.875"        | 18.475"         | 20"             | 22"           | 24    |
| ERK-2125           | FD-21             | PFD-21   | VFD-21        | LVFD-21                |                   | <b>E G</b>                       |            |           |                            | CBS-ERK-25, CBS-ERK-25R | ERK-RR21            | 36.75" (21 SP) | 40.875"        | 23.475"         | 25"             | 22"           | 24    |
| ERK-2720           | FD-27             | PFD-27   | VFD-27        | LVFD-27                |                   | <b>E G J</b>                     |            |           |                            | CBS-ERK-20, CBS-ERK-20R | ERK-RR27            | 47.5" (27 SP)  | 51.375"        | 18.475"         | 20"             | 22"           | 24    |
| ERK-2725           | FD-27             | PFD-27   | VFD-27        | LVFD-27                |                   | <b>E G J</b>                     |            |           |                            | CBS-ERK-25, CBS-ERK-25R | ERK-RR27            | 47.5" (27 SP)  | 51.375"        | 23.475"         | 25"             | 22"           | 24    |
| ERK-3520           | FD-35             | PFD-35   | VFD-35        | LVFD-35                |                   | <b>G J N</b>                     | ERK-VT     | ERK-ST    | ERK-4FT, ERK-6FT, ERK-10FT | CBS-ERK-20, CBS-ERK-20R | ERK-RR35            | 61.25" (35 SP) | 65.375"        | 18.475"         | 20"             | 22"           | 24    |
| ERK-3525           | FD-35             | PFD-35   | VFD-35        | LVFD-35                |                   | <b>G J N</b>                     | ERK-VT     | ERK-ST    | ERK-4FT, ERK-6FT, ERK-10FT | CBS-ERK-25, CBS-ERK-25R | ERK-RR35            | 61.25" (35 SP) | 65.375"        | 23.475"         | 25"             | 22"           | 24    |
| ERK-4020           | FD-40             | PFD-40   | VFD-40        | LVFD-40                |                   | <b>G N P</b>                     | ERK-VT     | ERK-ST    | ERK-4FT, ERK-6FT, ERK-10FT | CBS-ERK-20, CBS-ERK-20R | ERK-RR40            | 70" (40 SP)    | 74.125"        | 18.475"         | 20"             | 22"           | 24    |
| ERK-4025           | FD-40             | PFD-40   | VFD-40        | LVFD-40                |                   | <b>G N P</b>                     | ERK-VT     | ERK-ST    | ERK-4FT, ERK-6FT, ERK-10FT | CBS-ERK-25, CBS-ERK-25R | ERK-RR40            | 70" (40 SP)    | 74.125"        | 23.475"         | 25"             | 22"           | 24    |
| ERK-4420           | FD-44             | PFD-44   | VFD-44        | LVFD-44                |                   | <b>N P R T</b>                   | ERK-VT     | ERK-ST    | ERK-4FT, ERK-6FT, ERK-10FT | CBS-ERK-20, CBS-ERK-20R | ERK-RR44            | 77" (44 SP)    | 81.125"        | 18.475"         | 20"             | 22"           | 24    |
| ERK-4425           | FD-44             | PFD-44   | VFD-44        | LVFD-44                |                   | <b>N P R T</b>                   | ERK-VT     | ERK-ST    | ERK-4FT, ERK-6FT, ERK-10FT | CBS-ERK-25, CBS-ERK-25R | ERK-RR44            | 77" (44 SP)    | 81.125"        | 23.475"         | 25"             | 22"           | 24    |
| EWR-8-17/22        | FD-8              | PFD-8    | EVFD-8        |                        |                   | <b>C</b> **                      |            |           |                            |                         | DWR-RR8             | 14" (8 SP)     | 21"            | 15" / 20"       | 17.34" / 22.34" | 23.4"         | 42    |
| EWR-10-17/22       | FD-10             | PFD-10   | EVFD-10       |                        |                   | <b>C</b> **                      |            |           |                            |                         | DWR-RR10            | 17.5" (10 SP)  | 24.5"          | 15" / 20"       | 17.34" / 22.34" | 23.4"         | 42    |
| EWR-12-17/22       | FD-12             | PFD-12   | EVFD-12       |                        |                   | <b>C</b> **                      |            |           |                            |                         | DWR-RR12            | 21" (12 SP)    | 28"            | 15" / 20"       | 17.34" / 22.34" | 23.4"         | 42    |
| EWR-16-17/22       | FD-16             | PFD-16   | EVFD-16       |                        |                   | <b>C</b> **                      |            |           |                            |                         | DWR-RR16            | 28" (16 SP)    | 35"            | 15" / 20"       | 17.34" / 22.34" | 23.4"         | 42    |
| WMRK-2436          | FD-24             | PFD-24   | VFD-24        | LVFD-WMRK-24 SPN-24-36 |                   | <b>E G</b>                       | ERK-VT     | ERK-ST    | ERK-4FT, ERK-6FT, ERK-10FT | CBS-WMRK-36             | PROWMRK-RR24        | 42" (24 SP)    | 48.25"         | 33.5"           | 36"             | 24"           | 10    |
| WMRK-2442          | FD-24             | PFD-24   | VFD-24        | LVFD-WMRK-24 SPN-24-42 |                   | <b>E G</b>                       | ERK-VT     | ERK-ST    | ERK-4FT, ERK-6FT, ERK-10FT | CBS-WMRK-42             | PROWMRK-RR24        | 42" (24 SP)    | 48.25"         | 39.5"           | 42"             | 24"           | 10    |
| WMRK-4236          | FD-42             | PFD-42   | VFD-42        | LVFD-WMRK-42 SPN-42-36 |                   | <b>E G N P R T</b>               | ERK-VT     | ERK-ST    | ERK-4FT, ERK-6FT, ERK-10FT | CBS-WMRK-36             | PROWMRK-RR42        | 73.5" (42 SP)  | 79.625"        | 33.5"           | 36"             | 24"           | 10    |
| WMRK-4242          | FD-42             | PFD-42   | VFD-42        | LVFD-WMRK-42 SPN-42-42 |                   | <b>E G N P R T</b>               | ERK-VT     | ERK-ST    | ERK-4FT, ERK-6FT, ERK-10FT | CBS-WMRK-42             | PROWMRK-RR42        | 73.5" (42 SP)  | 79.625"        | 39.5"           | 42"             | 24"           | 10    |

▼ Requires PB-DWR to mount power strip (see pg. 98). \*\* **C** Mounts in center section channel or backpan and does not require PB-DWR. ● Requires PB-XS to mount power strip (see pg. 98). ■ Requires PB-5A to mount power strip (see pg. 98).



# Cross Reference

| RACK MODEL  | FRONT DOORS |        |               |               | SIDE PANELS | RECOMMENDED VERTICAL POWER STRIP | VENTED TOP | SOLID TOP | FAN TOP                    | SKIRTED WHEELBASE       | ADDITIONAL RACKRAIL    | RACKING HEIGHT | OVERALL HEIGHT | USEABLE DEPTH | OVERALL DEPTH | OVERALL WIDTH | PG. # |
|-------------|-------------|--------|---------------|---------------|-------------|----------------------------------|------------|-----------|----------------------------|-------------------------|------------------------|----------------|----------------|---------------|---------------|---------------|-------|
|             | SOLID       | PLEXI  | 22% OPEN AREA | 64% OPEN AREA |             |                                  |            |           |                            |                         |                        |                |                |               |               |               |       |
| WMRK-4248   | FD-42       | PFD-42 |               | LVFD-WMRK-42  | SPN-42-48   | <b>E G N P R T</b>               | ERK-VT     | ERK-ST    | ERK-4FT, ERK-6FT, ERK-10FT | CBS-WMRK-42             | PROWMRK-RR42           | 73.5" (42 SP)  | 79.625"        | 45.5"         | 48"           | 24"           | 10    |
| WMRK-4536   | FD-45       | PFD-45 |               | LVFD-WMRK-45  | SPN-45-36   | <b>E G N P R T</b>               | ERK-VT     | ERK-ST    | ERK-4FT, ERK-6FT, ERK-10FT | CBS-WMRK-36             | PROWMRK-RR45           | 78.5" (45 SP)  | 81.375"        | 33.5"         | 36"           | 24"           | 10    |
| WMRK-4542   | FD-45       | PFD-45 |               | LVFD-WMRK-42  | SPN-45-42   | <b>E G N P R T</b>               | ERK-VT     | ERK-ST    | ERK-4FT, ERK-6FT, ERK-10FT | CBS-WMRK-42             | PROWMRK-RR45           | 78.5" (45 SP)  | 81.375"        | 39.5"         | 42"           | 24"           | 10    |
| WMRK-4548   | FD-45       | PFD-45 |               | LVFD-WMRK-45  | SPN-45-48   | <b>E G N P R T</b>               | ERK-VT     | ERK-ST    | ERK-4FT, ERK-6FT, ERK-10FT | CBS-WMRK-48             | PROWMRK-RR45           | 78.5" (45 SP)  | 81.375"        | 45.5"         | 48"           | 24"           | 10    |
| MRK-2426    | FD-24       | PFD-24 | VFD-24        | LVFD-24       | SPN-24-267  | <b>E G</b>                       | MM-VT      | MM-ST     | MM-4FT, MM-6FT, MM-10FT    | CBS-MRK-26, CBS-MRK-26R | MM-RR24                | 42" (24 SP)    | 48.125"        | 24"           | 26.5"         | 22"           | 18    |
| MRK-2431    | FD-24       | PFD-24 | VFD-24        | LVFD-24       | SPN-24-312  | <b>E G</b>                       | MM-VT      | MM-ST     | MM-4FT, MM-6FT, MM-10FT    | CBS-MRK-31, CBS-MRK-31R | MM-RR24                | 42" (24 SP)    | 48.125"        | 29"           | 31.5"         | 22"           | 18    |
| MRK-3726    | FD-37       | PFD-37 | VFD-37        | LVFD-37       | SPN-37-267  | <b>E G</b>                       | MM-VT      | MM-ST     | MM-4FT, MM-6FT, MM-10FT    | CBS-MRK-26, CBS-MRK-26R | MM-RR37                | 64.75" (37 SP) | 70.875"        | 24"           | 26.5"         | 22"           | 18    |
| MRK-3731    | FD-37       | PFD-37 | VFD-37        | LVFD-37       | SPN-37-312  | <b>E G</b>                       | MM-VT      | MM-ST     | MM-4FT, MM-6FT, MM-10FT    | CBS-MRK-31, CBS-MRK-31R | MM-RR37                | 64.75" (37 SP) | 70.875"        | 29"           | 31.5"         | 22"           | 18    |
| MRK-4026    | FD-40       | PFD-40 | VFD-40        | LVFD-40       | SPN-40-267  | <b>N P</b>                       | MM-VT      | MM-ST     | MM-4FT, MM-6FT, MM-10FT    | CBS-MRK-26, CBS-MRK-26R | MM-RR40                | 70" (40 SP)    | 76.125"        | 24"           | 26.5"         | 22"           | 18    |
| MRK-4031    | FD-40       | PFD-40 | VFD-40        | LVFD-40       | SPN-40-312  | <b>N P</b>                       | MM-VT      | MM-ST     | MM-4FT, MM-6FT, MM-10FT    | CBS-MRK-31, CBS-MRK-31R | MM-RR40                | 70" (40 SP)    | 76.125"        | 29"           | 31.5"         | 22"           | 18    |
| MRK-4036    | FD-40       | PFD-40 | VFD-40        | LVFD-40       | SPN-40-36   | <b>N P R T</b>                   | MM-VT      | MM-ST     | MM-4FT, MM-6FT, MM-10FT    | CBS-MRK-36, CBS-MRK-36R | MM-RR40                | 70" (40 SP)    | 76.125"        | 33.6"         | 36"           | 22"           | 18    |
| MRK-4042    | FD-40       | PFD-40 | VFD-40        | LVFD-40       | SPN-40-423  | <b>N P R T</b>                   | MM-VT      | MM-ST     | MM-4FT, MM-6FT, MM-10FT    |                         | MM-RR40                | 70" (40 SP)    | 76.125"        | 39.5"         | 42"           | 22"           | 18    |
| MRK-4426    | FD-44       | PFD-44 | VFD-44        | LVFD-44       | SPN-44-267  | <b>N P R T</b>                   | MM-VT      | MM-ST     | MM-4FT, MM-6FT, MM-10FT    | CBS-MRK-26, CBS-MRK-26R | MM-RR44                | 77" (44 SP)    | 83.125"        | 24"           | 26.5"         | 22"           | 18    |
| MRK-4431    | FD-44       | PFD-44 | VFD-44        | LVFD-44       | SPN-44-312  | <b>N P R T</b>                   | MM-VT      | MM-ST     | MM-4FT, MM-6FT, MM-10FT    | CBS-MRK-31, CBS-MRK-31R | MM-RR44                | 77" (44 SP)    | 83.125"        | 29"           | 31.5"         | 22"           | 18    |
| MRK-4436    | FD-44       | PFD-44 | VFD-44        | LVFD-44       | SPN-44-36   | <b>N P R T</b>                   | MM-VT      | MM-ST     | MM-4FT, MM-6FT, MM-10FT    | CBS-MRK-36, CBS-MRK-36R | MM-RR44                | 77" (44 SP)    | 83.125"        | 33.6"         | 36"           | 22"           | 18    |
| MRK-4442    | FD-44       | PFD-44 | VFD-44        | LVFD-44       | SPN-44-423  | <b>N P R T</b>                   | MM-VT      | MM-ST     | MM-4FT, MM-6FT, MM-10FT    |                         | MM-RR44                | 77" (44 SP)    | 83.125"        | 39.5"         | 42"           | 22"           | 18    |
| SR-24-28    | FD-24       | PFD-24 | VFD-24        | LVFD-24       |             | <b>C E G J</b> ▼                 |            |           |                            |                         | DWR-RR24               | 42" (24 SP)    | 62.75"         | 26"           | 28"           | 24.34"        | 38    |
| SR-24-32    | FD-24       | PFD-24 | VFD-24        | LVFD-24       |             | <b>C E G J</b> ▼                 |            |           |                            |                         | DWR-RR24               | 42" (24 SP)    | 62.75"         | 30"           | 32"           | 24.34"        | 38    |
| SR-40-22    | FD-40       | PFD-40 | VFD-40        | LVFD-40       |             | <b>N P T</b> ▼                   |            |           |                            |                         | DWR-RR40               | 70" (40 SP)    | 90.25"         | 20"           | 22"           | 24.34"        | 38    |
| SR-40-28    | FD-40       | PFD-40 | VFD-40        | LVFD-40       |             | <b>N P T</b> ▼                   |            |           |                            |                         | DWR-RR40               | 70" (40 SP)    | 90.25"         | 26"           | 28"           | 24.34"        | 38    |
| SR-40-32    | FD-40       | PFD-40 | VFD-40        | LVFD-40       |             | <b>N P T</b> ▼                   |            |           |                            |                         | DWR-RR40               | 70" (40 SP)    | 90.25"         | 30"           | 32"           | 24.34"        | 38    |
| SR-46-28    | FD-46       | PFD-46 | VFD-46        |               |             | <b>N P T V</b> ▼                 |            |           |                            |                         | DWR-RR46               | 80.5" (46 SP)  | 95.875"        | 26"           | 28"           | 24.34"        | 38    |
| VMRK-54     | FD-54       | PFD-54 | VFD-54        |               | SPN-54-312  | <b>N P T V</b>                   | MM-VT      | MM-ST     | MM-4FT, MM-6FT, MM-10FT    |                         | VRR-54                 | 94.5" (54 SP)  | 100.625"       | 29"           | 31.40"        | 22"           | 22    |
| VRK-44-31H  | FD-44       | PFD-44 | VFD-44        | LVFD-44       | SPN-44-312  | <b>N P R T</b>                   | MM-VT      | MM-ST     | MM-4FT, MM-6FT, MM-10FT    |                         | MM-RR44                | 77" (44 SP)    | 83.125"        | 29"           | 31.40"        | 22"           | 20    |
| VRK-44-36H  | FD-44       | PFD-44 | VFD-44        | LVFD-44       | SPN-44-36   | <b>N P R T</b>                   | MM-VT      | MM-ST     | MM-4FT, MM-6FT, MM-10FT    |                         | MM-RR44                | 77" (44 SP)    | 83.125"        | 33.6"         | 36"           | 22"           | 20    |
| WRK-37-32   | WRFD-37     |        |               |               |             | <b>E G</b>                       | MM-VT      | MM-ST     | MM-4FT, MM-6FT, MM-10FT    |                         | WR-RR-37               | 64.75" (37 SP) | 75.625"        | 26"           | 32.875"       | 24"           | 48    |
| WRK-44-32   | WRFD-44     |        |               |               |             | <b>N P R T</b>                   | MM-VT      | MM-ST     | MM-4FT, MM-6FT, MM-10FT    |                         | WR-RR-44               | 77" (44 SP)    | 88.875"        | 26"           | 32.875"       | 24"           | 48    |
| WRK-24-27   | FD-24       | PFD-24 | VFD-24        | LVFD-24       | SPN-24-267  | <b>E G</b>                       | MM-VT      | MM-ST     | MM-4FT, MM-6FT, MM-10FT    | CBS-WRK-27, CBS-WRK-27R | WRK-RR24, PROWRK-RR-24 | 42" (24 SP)    | 48.125"        | 25.75"        | 27.5"         | 24.25"        | 16    |
| WRK-24-32   | FD-24       | PFD-24 | VFD-24        | LVFD-24       | SPN-24-312  | <b>E G</b>                       | MM-VT      | MM-ST     | MM-4FT, MM-6FT, MM-10FT    | CBS-WRK-32, CBS-WRK-32R | WRK-RR24, PROWRK-RR-24 | 42" (24 SP)    | 48.125"        | 30.75"        | 32.5"         | 24.25"        | 16    |
| WRK-245A-27 | FD-24       | PFD-24 | VFD-24        | LVFD-24       |             | <b>E G</b>                       | MM-VT      | MM-ST     | MM-4FT, MM-6FT, MM-10FT    | CBS-WRK-27, CBS-WRK-27R | WRK-RR24, PROWRK-RR-24 | 42" (24 SP)    | 48.125"        | 25.75"        | 27.5"         | 24.25"        | 14    |
| WRK-245A-32 | FD-24       | PFD-24 | VFD-24        | LVFD-24       |             | <b>E G</b>                       | MM-VT      | MM-ST     | MM-4FT, MM-6FT, MM-10FT    | CBS-WRK-32, CBS-WRK-32R | WRK-RR24, PROWRK-RR-24 | 42" (24 SP)    | 48.125"        | 30.75"        | 32.5"         | 24.25"        | 14    |
| WRK-37-27   | FD-37       | PFD-37 | VFD-37        | LVFD-37       | SPN-37-267  | <b>E G</b>                       | MM-VT      | MM-ST     | MM-4FT, MM-6FT, MM-10FT    | CBS-WRK-27, CBS-WRK-27R | WRK-RR37, PROWRK-RR-37 | 64.75" (37 SP) | 70.875"        | 25.75"        | 27.5"         | 24.25"        | 16    |
| WRK-37-32   | FD-37       | PFD-37 | VFD-37        | LVFD-37       | SPN-37-312  | <b>E G</b>                       | MM-VT      | MM-ST     | MM-4FT, MM-6FT, MM-10FT    | CBS-WRK-32, CBS-WRK-32R | WRK-RR37, PROWRK-RR-37 | 64.75" (37 SP) | 70.875"        | 30.75"        | 32.5"         | 24.25"        | 16    |
| WRK-375A-27 | FD-37       | PFD-37 | VFD-37        | LVFD-37       |             | <b>E G</b>                       | MM-VT      | MM-ST     | MM-4FT, MM-6FT, MM-10FT    | CBS-WRK-27, CBS-WRK-27R | WRK-RR37, PROWRK-RR-37 | 64.75" (37 SP) | 70.875"        | 25.75"        | 27.5"         | 24.25"        | 14    |
| WRK-375A-32 | FD-37       | PFD-37 | VFD-37        | LVFD-37       |             | <b>E G</b>                       | MM-VT      | MM-ST     | MM-4FT, MM-6FT, MM-10FT    | CBS-WRK-32, CBS-WRK-32R | WRK-RR37, PROWRK-RR-37 | 64.75" (37 SP) | 70.875"        | 30.75"        | 32.5"         | 24.25"        | 14    |
| WRK-40-27   | FD-40       | PFD-40 | VFD-40        | LVFD-40       | SPN-40-267  | <b>N P T</b>                     | MM-VT      | MM-ST     | MM-4FT, MM-6FT, MM-10FT    | CBS-WRK-27, CBS-WRK-27R | WRK-RR40, PROWRK-RR-40 | 70" (40 SP)    | 76.125"        | 25.75"        | 27.5"         | 24.25"        | 16    |
| WRK-40-32   | FD-40       | PFD-40 | VFD-40        | LVFD-40       | SPN-40-312  | <b>N P T</b>                     | MM-VT      | MM-ST     | MM-4FT, MM-6FT, MM-10FT    | CBS-WRK-32, CBS-WRK-32R | WRK-RR40, PROWRK-RR-40 | 70" (40 SP)    | 76.125"        | 30.75"        | 32.5"         | 24.25"        | 16    |
| WRK-405A-27 | FD-40       | PFD-40 | VFD-40        | LVFD-40       |             | <b>N P T</b>                     | MM-VT      | MM-ST     | MM-4FT, MM-6FT, MM-10FT    | CBS-WRK-27, CBS-WRK-27R | WRK-RR40, PROWRK-RR-40 | 70" (40 SP)    | 76.125"        | 25.75"        | 27.5"         | 24.25"        | 14    |
| WRK-405A-32 | FD-40       | PFD-40 | VFD-40        | LVFD-40       |             | <b>N P T</b>                     | MM-VT      | MM-ST     | MM-4FT, MM-6FT, MM-10FT    | CBS-WRK-32, CBS-WRK-32R | WRK-RR40, PROWRK-RR-40 | 70" (40 SP)    | 76.125"        | 30.75"        | 32.5"         | 24.25"        | 14    |
| WRK-44-27   | FD-44       | PFD-44 | VFD-44        | LVFD-44       | SPN-44-267  | <b>N P R T</b>                   | MM-VT      | MM-ST     | MM-4FT, MM-6FT, MM-10FT    | CBS-WRK-27, CBS-WRK-27R | WRK-RR44, PROWRK-RR-44 | 77" (44 SP)    | 83.125"        | 25.75"        | 27.5"         | 24.25"        | 16    |
| WRK-44-32   | FD-44       | PFD-44 | VFD-44        | LVFD-44       | SPN-44-312  | <b>N P R T</b>                   | MM-VT      | MM-ST     | MM-4FT, MM-6FT, MM-10FT    | CBS-WRK-32, CBS-WRK-32R | WRK-RR44, PROWRK-RR-44 | 77" (44 SP)    | 83.125"        | 30.75"        | 32.5"         | 24.25"        | 16    |
| WRK-445A-27 | FD-44       | PFD-44 | VFD-44        | LVFD-44       |             | <b>N P R T</b>                   | MM-VT      | MM-ST     | MM-4FT, MM-6FT, MM-10FT    | CBS-WRK-27, CBS-WRK-27R | WRK-RR44, PROWRK-RR-44 | 77" (44 SP)    | 83.125"        | 25.75"        | 27.5"         | 24.25"        | 14    |
| WRK-445A-32 | FD-44       | PFD-44 | VFD-44        | LVFD-44       |             | <b>N P R T</b>                   | MM-VT      | MM-ST     | MM-4FT, MM-6FT, MM-10FT    | CBS-WRK-32, CBS-WRK-32R | WRK-RR44, PROWRK-RR-44 | 77" (44 SP)    | 83.125"        | 30.75"        | 32.5"         | 24.25"        | 14    |

▼ Requires PB-DWR to mount power strip (see pg. 98) unless mounting **N** PD-2415SC or **C** PD-815SC in center section channel.

AS A RESULT OF OUR EXPANDED VERTICAL POWER STRIP OFFERING & FOR ENHANCED ACCURACY, WE HAVE UPDATED OUR VERTICAL POWER STRIP SIZING SYSTEM. PLEASE SEE PGS. 64-79 FOR A LISTING OF POWER STRIP SIZES, OR VISIT MIDDLEATLANTIC.COM.



# Where to Use Middle Atlantic Products

Welcome to the 2008-2009 Middle Atlantic Products master catalog. This catalog showcases our comprehensive line of engineered mounting solutions. From Racks and Enclosures to Monitoring Consoles, we have the solutions needed to get the job done quicker, while taking into account the thermal, power distribution and control, cable, and space management requirements of each installation. Please refer to page 3 to select the products that you need by type. If you know the model number of the product that you are looking for, use the alphabetical listing on page 2 to find it easily. The application guide below lists appropriate solutions for each type of installation, and the page numbers where they can be found.

## Recommended Enclosure Systems Based on Venue and Application

| Venue Type                                 | Audio & Sound Systems    | Video & Security     | Intercom & Paging | Structured Cabling/Networking         |        |
|--|--------------------------|----------------------|-------------------|---------------------------------------|--------|
| RESTAURANT, LOUNGE, NIGHT CLUB, SPORTS BAR | ERK 24  ASR/ASR-HD 54-55 | MRK 18  TOR 46       | DWR 40  TOR 46    | WMRK 10  IDF 44                       |        |
|  | DWR 40  IDF 44           | DWR 40  DLB/VLBX 45  | IDF 44            | DWR 40  SFR/SGR 60                    |        |
| CORPORATE COMMERCIAL BUILDINGS             | MRK 18  DWR 40           | IDF 44  LCD DESK 88  | ERK 24  IDF 44    | WMRK 10  IDF 44                       |        |
|  | ISRK 36  IDF 44          | DLB 45  R4 56        | DWR 40  WRS 47    | DRK 14  R4 56                         |        |
| MEETING, CONFERENCE, BOARDROOM             | PTRK 37  SRSR 42         | IDF 44  LCD DESK 88  | DWR 40  TOR 46    | WMRK 10  IDF 44                       |        |
|  | AXS 49  ASR/ASR-HD 54-55 | DLB 45  R4 56        | WRS 47  SBX 47    | DRK 14  R4 56                         |        |
| EDUCATIONAL CLASSROOM                      | ISRK 36  DWR 40          | ISRK 36  DLB/VLBX 45 | DWR 40  EWR 42    | WMRK 10  R4 56                        |        |
|  | PTRK 37  TOR 46          | DWR 40  LCD DESK 88  | IDF 44  TOR 46    | SR 38  SFR 60                         |        |
| HOUSE OF WORSHIP                           | MRK 18  TOR 46           | DWR 40  TOR 46       | DWR 40  WRS 47    | WMRK 10  R4 56                        |        |
|  | DWR 40  BRK 34           | DLB 45  SCRK 94      | TOR 46  SBX 47    | SR 38  SFR 60                         |        |
| RETAIL, SERVICE SHOPS, MALLS               | DWR 40  IDF 44           | DWR 40  TOR 46       | DWR 40  TOR 46    | WMRK 10  IDF 44                       |        |
|  | EWR 42  TOR 46           | DLB 45  R4 56        | IDF 44  WRS 47    | SR 38  R4 56                          |        |
| HOTEL, MOTEL                               | MRK 18  DWR 40           | DWR 40  LCD DESK 88  | DWR 40  TOR 46    | WMRK 10  R4 56                        |        |
|  | ISRK 36  IDF 44          | DLB 45  R4 56        | IDF 44  WRS 47    | SR 38  SFR 60                         |        |
| MEDICAL AND HEALTH CARE                    | MRK 18  SBX 47           | DWR 40  LCD DESK 88  | DWR 40  TOR 46    | WMRK 10  R4 56                        |        |
|  | DWR 40  WR 48            | DLB 45  SCRK 94      | IDF 44  WRS 47    | SR 38  PPM 61                         |        |
| RECREATION, SPORTS VENUES                  | MRK 18  WR 48            | VRK 20  DLB 45       | DWR 40  TOR 46    | WMRK 10  R4 56                        |        |
|  | DWR 40  R4 56            | DWR 40  LCD DESK 88  | IDF 44  WRS 47    | SR 38  PPM 61                         |        |
| MANUFACTURING, WAREHOUSING                 | MRK 18  IDF 44           | MRK 20  WR 48        | DWR 40  TOR 46    | WMRK 10  R4 56                        |        |
|  | DWR 40  WR 48            | DWR 40  R4 76        | IDF 44  WRS 47    | DWR 40  HDR 62                        |        |
| CUSTOM RESIDENTIAL                         | ERK 24  SRSR 52          | DWR 40  HDR 62       | SR 38             | <b>Network Distribution/Telephone</b> |        |
|  | AXS 50  ASR/ASR-HD 54-55 | DLB 45               | DWR 40            | WRS 47                                | HDR 62 |
|  |                          |                      |                   | SFR 60                                | WM 63  |



**Server Enclosure**

**Pg. 10**



Now available in new sizes, and as a non-configured cabinet (configured models are also available for easy ordering), the WMRK Series Server Enclosures are in stock and mount virtually any server.

**Slim 5 Enhancements, Options**

**Pgs. 32-33**



The Slim 5 ready-to-assemble enclosure has been enhanced with a new thermal management option, an optional runner kit which allows the Slim 5 to slide easily in credenzas and other millwork, and aesthetic side and top options.

**Laminate Racks Expanded Line Up**

**Pg. 34**



The popular BRK line of ready-to-assemble wooden racks has received a new color option, new depths (up to 28" deep) and new heights (up to 28 rackspaces), as well as new accessories that extend the usability and application of this economical, yet aesthetic mounting solution.

**Enhanced Custom Rackshelves**

**Pgs. 116-117**



RSH Series Custom Rackshelves now boast enhanced ventilation, a scratch resistant Perma-Black™ anodized finish, and simplified installation with the Mighty Stud™ fastener. These enhancements are in addition to our extensive 8,500+ component database, and 48 hour manufacturing turnaround.

**Duct Cool™ Long Pull Vent System**

**Pg. 87**



Ideal for cooling closets, racks, and projector enclosures remotely and quietly. The Duct Cool™ features a powerful, but quiet, inline mixed flow fan that is capable of removing air from up to 25' away.

**High CFM Split Rear Doors**

**Pg. 29**



Cool cabinets with high-heat producing DVRs and NVRs with this innovative rear door. With 6 powerful fans (standard) that can be positioned where needed, this door has an impressive 1320 CFM free air rating – more fans can be added, providing up to 3,520 CFM.

**LCD Monitoring Desk Enhancements**

**Pgs. 88-89**



This versatile, modular desk has been enhanced in 2 critical areas: Ergonomics and Aesthetics. Notable improvements have been made to both desk height as well as line of sight (when used with low-profile monitor arms), to keep in line with evolving customer needs. The aesthetic improvements are highlighted by a new overall look and new color options.

**Multimedia Studio Furniture Enhancements**

**Pgs. 100-103**

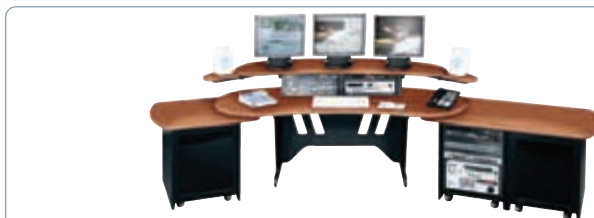

The premium line of Edit Center™ furniture has been redesigned with a new look, and new color options, including dark cherry, honey maple, & pepperstone.

**Signal-Safe™ IEC Cords**

**Pg. 65**



Our IEC Cord offering has been expanded and enhanced. New lengths, pre-pack sizes, and plug options are now available, and all feature **Signal-Safe™ technology, which virtually eliminates all magnetic fields from the wire.**

**Rackmount Power Distribution**

**Pgs. 76-77**



More choices are now available, including a single rackspace unit that monitors power for 8 important parameters, including voltage, current and frequency.

**Essential Cable Management Accessory**

**Pg. 31**



The Anti-Slip cable pad enhances system reliability by supporting the weight of the cables being managed by up to 40%! This pad mounts to LACE-OWP series vertical lacer strips, and uses a unique high friction technology to reduce pull on connectors and tie points.

**Enhanced Digital Video Recorder Lockbox**

**Pg. 45**



DVRs produce more heat than ever, and the DLBX Series Digital Video Recorder Lockbox has been enhanced with additional ventilation and cooling fans to better protect this critical piece of monitoring equipment.



# The Power of the Integrated System

Complete, optimized and professional installations are the result of proper planning for a fully integrated enclosure system. A fully integrated enclosure system incorporates four essential values that work together to ensure system reliability: the mounting system, thermal management, cable management and power distribution. The **mounting system** is the foundation, and incorporates time and labor saving features, addresses space constraints, structural needs, is compliant with applicable construction/building codes, and meets the aesthetic needs of the environment. **Power distribution** is needed in every system, and proper planning to ensure that all grounding protection and distribution needs are met is critical to ensure that the system performs properly. Maintaining an optimal internal operating temperature is the goal of **thermal management**, and is critical to system reliability. The primary purpose of **cable management** is to maintain the integrity of the signal, and facilitate installation, upgrades and servicing of the system.

Middle Atlantic Products offers a complete line of engineered mounting solutions that come together to provide a complete, integrated enclosure system.



## Mounting System

- ✓ Floor, wall, and ceiling mount rack and enclosure systems, as well as unique slide out systems for space restricted environments
- ✓ Includes built-in cable management and time saving features
- ✓ UL Listed and Seismic certified mounting products available
- ✓ Solutions available to meet the aesthetic needs of any installation



## Power Distribution

- ✓ Electrical products range from vertical strips to rackmount units with modular, configurable, space saving, sequencing and monitoring capabilities
- ✓ Multiple circuit, outlet, termination and protection options are available to fit the individual needs of each application



## Thermal Management

- ✓ Thermally designed racks and enclosures feature engineered ventilation locations, top options and accessories allowing the specifier or installer to design a passively or actively cooled system
- ✓ Cooling options, including a proportional speed thermostatic fan control, extend equipment life and reduce maintenance requirements

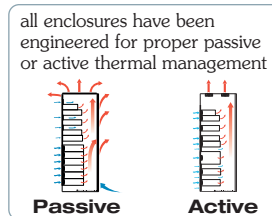

## Cable Management

- ✓ Engineered enclosures accept an extensive selection of lacing options
- ✓ Removable knockouts for cable pass-through
- ✓ Abundant cable lacing points simplify cable management
- ✓ Most rack top options feature a removable 2 rackspace service plate for easy removal of top option without disturbing cable bundles





# Racks and Enclosures Features and Benefits

## Innovative Solutions for Space Restricted Environments

- ✓ Slide-out and rotating equipment racks provide increased serviceability when rear access is not available
- ✓ Tall 54 rackspace enclosures for installations where floor space is an issue, but ceiling height is not
- ✓ Pivoting racks provide easy access to equipment connections

## Time Savers

- ✓ Rackrail is labeled in rackspace increments, facilitating easy equipment alignment and is finished in durable e-coat guaranteeing no clogged threads
- ✓ Pre-installed washers and self-guiding pilot-points on 10-32 threaded rack screws save valuable installation time
- ✓ Ganging holes on selected enclosures (MRK, DRK, VRK, VMRK and WMRK Series) allow racks to be joined while fully loaded

## Agency Compliancy

- ✓ Most welded floor standing enclosures are UL Listed with a weight capacity of 2,500 lbs.
- ✓ Most welded floor standing enclosures are Zone 4 and Seismic Use Group III certified and are now certified to UBC, CBC, IBC, ASCE and NFPA standards
- ✓ Studs provided in base of all welded floor standing racks facilitate the proper grounding and bonding of electrical equipment, as per NEBS and NEC standards

## What Does 'UL Listed' Mean?

The UL Listing is a rating that certifies a product has been tested by Underwriter's Laboratories to meet certain safety standards. Underwriter's Laboratories is the leader in U.S. product safety and certification. The UL Listing is found on the majority of our products, provides the confidence that the product is safe for use, and is often a requirement in many installations. In addition, most welded floor standing Middle Atlantic Products enclosures have a UL Listed 2,500 lb. weight capacity, ensuring that they can safely protect critical electronic systems. **Products with UL Listings that relate to weight ratings have been tested to four times the published capacity.**

## What Does 'Seismic Certified' Mean?

Seismic certification ensures that the essential equipment housed in the enclosure can survive a seismic event. This is critical in the many seismic areas throughout the world, and is often a requirement in other installations as well. Most welded, floor standing Middle Atlantic Products enclosures are seismic certified at no extra charge, which ensures that they provide the structural integrity required for your installation to meet UBC, CBC, IBC, ASCE and NFPA standards.



electrical knockout plates are now split and provide knockouts for UHF/VHF antennas as well as 1/2", 3/4", 1" and 1 1/2" electrical knockouts

rackrail brackets feature infinite adjustment as well as fixed rail positions, and provide convenient cable tie points. Mix threaded 10-32 rackrail and cage nut style rackrail in-line, does not need to be offset!

spring-loaded hinge pins allow quick removal and reversal of flush mounted rear doors

selectively vented rear doors on racks (WRK, MRK, ERK Series) feature laser knockouts on top and bottom to accept fans, vents and filters

all enclosures feature one-piece sides (no welded seams) for exceptional strength



each rack top features an opening that accepts a variety of top options for equipment mounting and thermal management

convenient lift-off side panels allow easy access to components and cables, and feature an outside keylock for security

convenient surface mounted metal hinge provides front door mounting without the need for equipment removal

standard locking rear door includes spring-latch, stays closed without a key

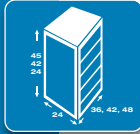

# WMRK Series Multi-Vendor Server Enclosure

Select a WMRK for use with Servers from Leading Manufacturers

TIA/EIA COMPLIANT

A&E SPEC. # 96-01079

## Structural Features

- ✓ 24" overall width optimized for use on raised floors
- ✓ Fully welded construction provides a 2,500 lb. static load capacity
- ✓ Standard front and rear adjustable cage nut style rail with rear Z-rail adaptors accommodates most server slide kits
- ✓ Numbered rackspace increments speed equipment mounting
- ✓ 14-gauge steel tops and bottoms, 16-gauge seamless steel sides and 11-gauge thickness where the rail brackets are welded to the sides. Each model is equipped with laser cut 1/8" thick internal braces made from structural steel which enhance strength and provide more useable internal space
- ✓ Racks gang together when fully loaded
- ✓ Includes leveling feet
- ✓ Finished in a durable black textured powder coat

## Cable Management

- ✓ 1/2", 3/4", 1" and 1 1/2" electrical knockouts found on rear plates, top knockout plate additionally includes UHF/VHF antenna knockouts
- ✓ Removable split bottom rear panel allows cable bundles to be easily passed over or under the WMRK's standard key-locking split rear doors
- ✓ Rack top includes UHF/VHF antenna knockouts and integral mounting points for 6", 9", 12" and 18" wide cable ladders
- ✓ Rack top includes five integral gland grommeted 4" cable pass-throughs (48" depth includes 7)
- ✓ Designed to allow fully integrated racks to be ganged

## Compliance

- ✓ Rail has been configured to accept servers and slide kits from all leading manufacturers
- ✓ Perforation on front and rear doors and top options meets server manufacturer warranty specifications
- ✓ Stud in base of rack facilitates the proper grounding and bonding of electronic equipment, as per NEBS and NEC standards

## Time Savings

- ✓ Available configured, to simplify ordering and assembly, or as a rack frame only

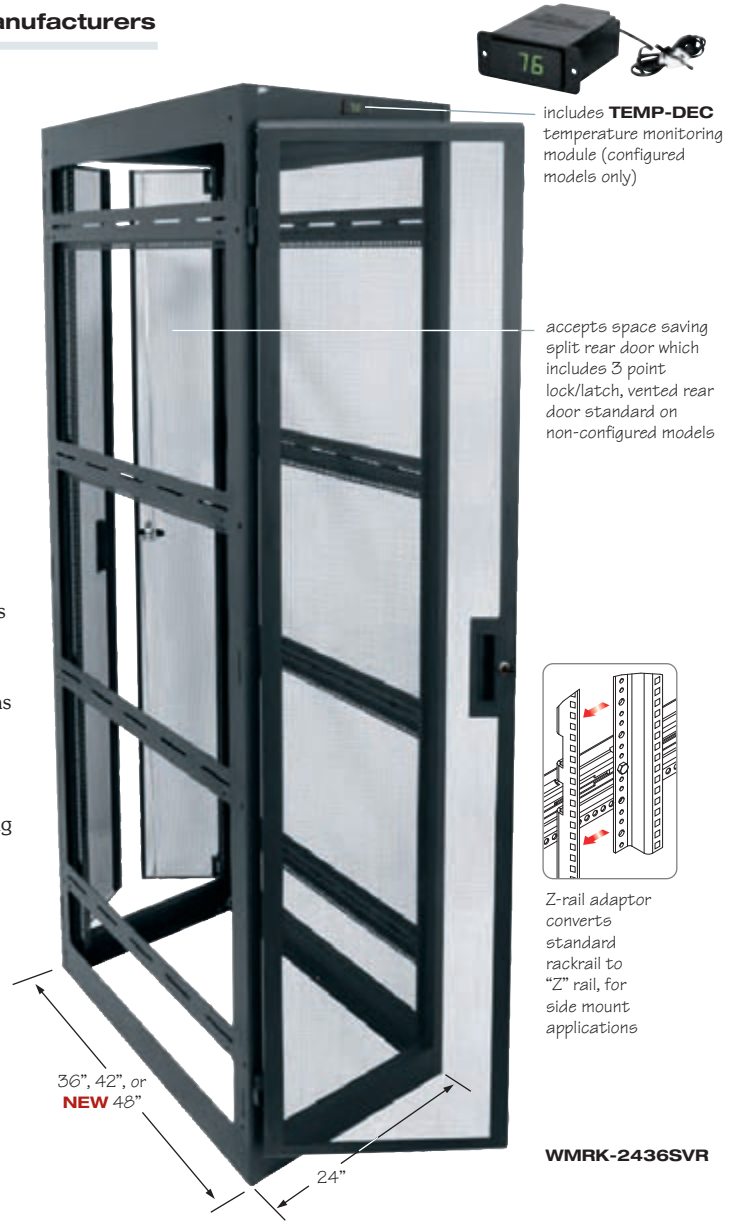

## Rack Only

| 36" Outside Depth (33 1/2" Useable) Part # | 42" Outside Depth (39 1/2" Useable) Part # | 48" Outside Depth (45 1/2" Useable) Part # | Racking Height     | Overall Height | Recommended Power  |
|--|--|--|--------------------|----------------|--------------------|
| <b>NEW</b> WMRK-4536                       | <b>NEW</b> WMRK-4542                       | <b>NEW</b> WMRK-4548                       | 78 3/4" (45 space) | 85"            | <b>E G</b>         |
| <b>NEW</b> WMRK-4236                       | <b>NEW</b> WMRK-4242                       | <b>NEW</b> WMRK-4248                       | 73 1/2" (42 space) | 80"            | <b>E G N P R T</b> |
| <b>NEW</b> WMRK-2436                       | <b>NEW</b> WMRK-2442                       | -  | 42" (24 space)     | 48 1/2"        | <b>E G N P R T</b> |







## Configured Models

| 36" Outside Depth (33 1/2" Useable), with sides Part # | 36" Outside Depth (33 1/2" Useable), without sides Part # | 42" Outside Depth (39 1/2" Useable), with sides Part # | 42" Outside Depth (39 1/2" Useable), without sides Part # | Racking Height     | Overall Height |
|--|---|--|---|--------------------|----------------|
| WMRK-4236SVR   | WMRK-4236SVR-AB   | WMRK-4242SVR   | WMRK-4242SVR-AB   | 73 1/2" (42 space) | 79 5/8"        |
| WMRK-2436SVR   | WMRK-2436SVR-AB   | -  | -   | 42" (24 space)     | 48 1/4"        |







# WMRK Series Multi-Vendor Server Enclosure

See pgs. 26-31 for more information.

## Top Options

|   |   |  |  |   |   |
|---|---|--|--|---|---|
|  |  |                                     |  |    |  |
| <b>ERK-ST</b><br>solid  | <b>ERK-VT</b><br>vented   | <b>ERK-10FT</b><br>mounts one 10" fan<br><b>ERK-10FT-550CFM</b><br>with fan <b>ERK-10FT-FC</b><br>with fan + control | <b>ERK-6FT</b><br>mounts two 6" fans<br><b>ERK-6FT-440CFM</b><br>with fans         | <b>ERK-4FT</b><br>mounts three 4½" fans<br><b>ERK-4FT-285CFM</b><br>with fans <b>ERK-4QFT-FC</b><br>with quiet fans + control | <b>ERK-DT</b><br>duct cool<br>adapter<br>see pg. 87                                 |

## Door Options

|   |   |   |   |  |   |   |                        |
|---|---|---|---|--|---|---|------------------------|
|  |  |  |  |  |  |  |                        |
| <b>Rack Part #</b>  | <b>Front Doors</b>  |   |   |  | <b>Split Rear Doors</b>   |   |                        |
|   | <b>Solid</b>  | <b>Plexi</b>  | <b>25% Open Area</b>  | <b>70% Open Area</b>   | <b>79% Open Area</b>  | <b>Solid*</b>   | <b>Fan, 1320 CFM**</b> |
| WMRK-45xx   | FD-45   | PFD-45  | –   | LVFD-WMRK-45   | MW-CLVRD-45   | MW-CRD-45   | MW-CFRD-45             |
| WMRK-42xx   | FD-42   | PFD-42  | –   | LVFD-WMRK-42   | MW-CLVRD-42   | MW-CRD-42   | MW-CFRD-42             |
| WMRK-24xx   | FD-24   | PFD-24  | VFD-24  | LVFD-WMRK-24   | MW-CLVRD-24   | MW-CRD-24   | –                      |

\*accepts rear door fan (KO-CRD-FAN) and vent (KO-CRD-VT) kits  
\*\*accepts additional fans, see pg. 85 for details.

## Side Panels

|   |                                 |
|---|---------------------------------|
|  |                                 |
| <b>Rack Part #</b>  | <b>Split Side Panels Part #</b> |
| WMRK-4536   | SPN-45-36                       |
| WMRK-4542   | SPN-45-42                       |
| WMRK-4548   | SPN-45-48                       |
| WMRK-4236   | SPN-42-36                       |
| WMRK-4242   | SPN-42-42                       |
| WMRK-4248   | SPN-42-48                       |
| WMRK-2436   | SPN-24-36                       |
| WMRK-2442   | SPN-24-42                       |

## Caster and Plenum Bases

**NEW**

caster base allows the rack to be wheeled into place, then raised via leveling feet

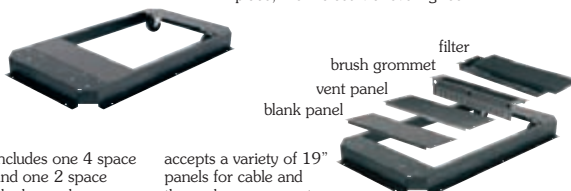

includes one 4 space and one 2 space blank panel

accepts a variety of 19" panels for cable and thermal management

| <b>Rack Part #</b> | <b>Commercial Grade Caster Bases</b> | <b>Plenum Bases</b> |
|--------------------|--------------------------------------|---------------------|
| WMRK-xx48          | CBS-WMRK-48                          | PBS-WMRK-48         |
| WMRK-xx42          | CBS-WMRK-42                          | PBS-WMRK-42         |
| WMRK-xx36          | CBS-WMRK-36                          | PBS-WMRK-36         |

## Additional Rail

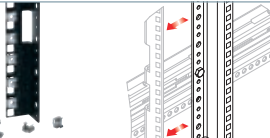
|   |                                |                             |
|---|--------------------------------|-----------------------------|
|  |                                |                             |
| <b>Part #</b>   | <b>Add'l Cage Nut Rackrail</b> | <b>Add'l Z-rail Adaptor</b> |
| WMRK-45xx   | PROWMRK-RR45                   | PROWMRK-ZRA-45              |
| WMRK-42xx   | PROWMRK-RR42                   | PROWMRK-ZRA-42              |
| WMRK-24xx   | PROWMRK-RR24                   | PROWMRK-ZRA-24              |

## Configured Models Come Complete with:

- ✓ 70% open area front door, locking
- ✓ 79% open area split rear door, locking
- ✓ 64% open area top
- ✓ Temperature monitoring module
- ✓ Vertical lacing strip, 3¼" width (42 space only)
- ✓ 6 mm cage nuts, 100 quantity
- ✓ 6 mm rack screws, 100 quantity
- ✓ 20 Amp, 20 outlet (42 space) or 10 outlet (24 space) corded power strip
- ✓ Side panels (models with sides only)
- ✓ Ganging hardware (models without sides only)
- ✓ Leveling feet

## Top View

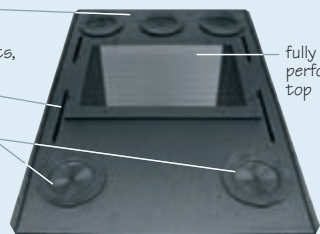

four UHF/VHF antenna knockouts

cable ladder mounts, side-to-side or front-to-rear

fully perforated top

five 4" opening gland grommets for cable pass through (seven on 48" depth)

# DRK Series Cable Management Enclosures

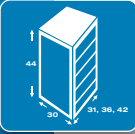

## Provides High Density Cable Management and Multiple Panel Widths

Specify a DRK for use in network patching and other high-density cable management applications. Wide 30" footprint provides generous amounts of internal cable space and accommodates 19" and 23" panel width equipment.

### Structural Features

- ✓ Fully welded construction provides:
  - Static load capacity, 10,000 lbs.
  - UL Listed load capacity, 2,500 lbs.
  - Seismic Certified load capacity, 750 lbs.
- ✓ 14-gauge steel tops and bottoms, 16-gauge seamless steel sides and 11-gauge thickness where the rail brackets are welded to the sides
- ✓ Racks gang together when fully loaded
- ✓ Finished in a durable black textured powder coat

### Thermal Management

- ✓ Standard vented rear door is reversible to allow opening from either direction
- ✓ Standard 10" fan top comes with a fan guard, 10" fan optional

### Cable Management

- ✓ 19" EIA panel width enclosures come standard with two front-mounted vertical cable ducts featuring abundant cable entry points and a full-length hinged door with three-point magnetic catches
- ✓ 1/2", 3/4", 1" and 1 1/2" electrical knockouts found on removable split rear plates, top knockout plate additionally includes UHF/VHF antenna knockouts

### Time Savings

- ✓ Numbered rackspace increments speed equipment mounting
- ✓ Standard front and rear adjustable rackrail available in 19" and 23" panel widths for a multitude of equipment mounting needs
- ✓ Factory configured 19" EIA panel width DRK enclosure additionally outfitted with pair of keylocked side panels, plexi front door and leveling feet, 10" fan top with guard, available for easier ordering and to save installation time (part # DRK19-44-31K)
- ✓ Includes 100 rack screws

### Code Compliancy

- ✓ Seismic Certified to the 1997 UBC and 2001 CBC Seismic Zone 4 and the 2000 IBC, 2003 IBC, 2002 ASCE Standard 7 and 2003 NFPA 5000 Seismic Use Group III lateral force requirements for protecting 750 lbs. of essential equipment in upper floor installations when used with optional MRK-Z4 seismic floor anchor brackets (see pg. 30) with an Ip value of 1.5
- ✓ Stud in base of enclosure facilitates the proper grounding and bonding of electronic equipment, as per NEBS and NEC standards
- ✓ UL Listed in the US and Canada

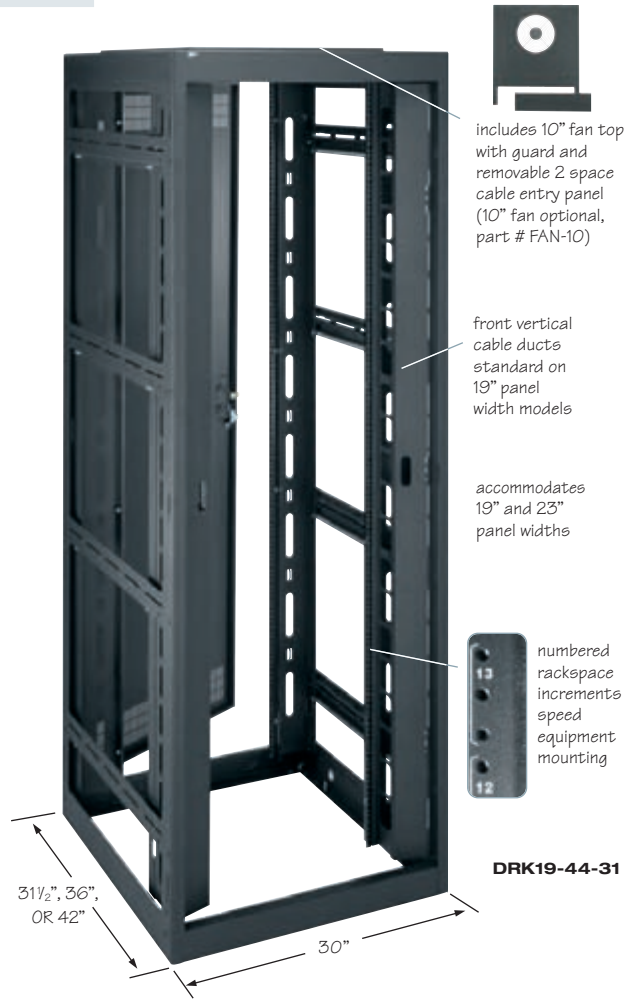

**DRK19-44-31**

**WE WILL CONFIGURE THIS CABINET TO YOUR NEEDS!**  
Call 800-266-7225

**DRK19-44-31** shown with optional vented plexi front door (DPVFD-44) and side panels



UL LISTED  
UL  
SEISMIC CERTIFIED  
TIA/EIA COMPLIANT

A&E SPEC. # 96-967  
(DRK19 - 19" PANEL WIDTH)

A&E SPEC. # 96-970  
(DRK23 - 23" PANEL WIDTH)

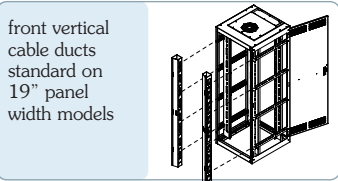

front vertical cable ducts standard on 19" panel width models

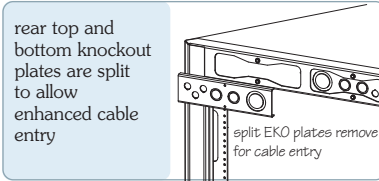

rear top and bottom knockout plates are split to allow enhanced cable entry

split EKO plates remove for cable entry

| Part #         | Panel Width | Rackrail   | Racking Height | Overall Height | Useable Depth | Outside Depth | Outside Width | Recommended Power |
|----------------|-------------|--|----------------|----------------|---------------|---------------|---------------|-------------------|
| DRK19-44-31    | 19"         | 10-32 threaded on EIA standard spacing               | 77" (44 space) | 83 1/2"        | 24 1/4"       | 31 1/2"       | 30"           | N P R T           |
| DRK19-44-31K*  | 19"         | 10-32 threaded on EIA standard spacing               | 77" (44 space) | 83 1/2"        | 24 1/4"       | 31 1/2"       | 30"           | N P R T           |
| DRK19-44-31PRO | 19"         | square hole (cage nut style) on EIA standard spacing | 77" (44 space) | 83 1/2"        | 24 1/4"       | 31 1/2"       | 30"           | N P R T           |
| DRK19-44-36    | 19"         | 10-32 threaded on EIA standard spacing               | 77" (44 space) | 83 1/2"        | 28 3/4"       | 36"           | 30"           | N P R T           |
| DRK19-44-36PRO | 19"         | square hole (cage nut style) on EIA standard spacing | 77" (44 space) | 83 1/2"        | 28 3/4"       | 36"           | 30"           | N P R T           |
| DRK19-44-42    | 19"         | 10-32 threaded on EIA standard spacing               | 77" (44 space) | 83 1/2"        | 34 3/4"       | 42"           | 30"           | N P R T           |
| DRK19-44-42PRO | 19"         | square hole (cage nut style) on EIA standard spacing | 77" (44 space) | 83 1/2"        | 34 3/4"       | 42"           | 30"           | N P R T           |
| DRK23-44-31    | 23"         | 10-32 threaded on EIA standard spacing               | 77" (44 space) | 83 1/2"        | 28 1/4"       | 31 1/2"       | 30"           | N P R T           |

NOTE: Above 19" panel width racks available less rear door. To order, suffix part # with 'LRD'. \*Includes 10" fan top with guard, keylocked side panels, plexi front door and leveling feet. See pgs. 64-79 for complete list of power products.

# DRK Series Cable Management Enclosure Options

See pgs. 26-31 for more information.

**Top Options** most top options feature a removable 2 rackspace service plate



|   |  |   |  |  |  |  |   |
|---|--|---|--|--|--|--|---|
|   |  |   |  |  |  |  |   |
| <b>MW-ST</b><br>solid <b>MW-LVT</b><br>64% open<br>area <b>MW-VT</b> slot<br>pattern vented | <b>MW-10FT</b><br>(included) mounts one 10" fan<br><b>MW-10FT-550CFM</b><br>with fan <b>MW-10FT-FC</b><br>with fan + control | <b>MW-6FT</b><br>mounts three<br>6" fans<br><b>MW-6FT-660CFM</b><br>with fans | <b>MW-4FT</b><br>mounts four 4 1/2" fans<br><b>MW-4FT-380CFM</b><br>with fans <b>MW-4QFT-FC</b><br>with quiet fans + control | <b>MW-DT</b><br>duct cool<br>adapter<br>see pg. 87 | <b>MW-LA</b><br>accepts<br>6" and 12"<br>cable ladders | <b>MW-TR</b><br>top-mounted<br>rail option,<br>13 spaces | <b>BR2</b><br>2 space brush<br>grommet fits top<br>option opening |

## Door Options

|                     |              |                      |                     |                         |                         |                      |               |
|---------------------|--------------|----------------------|---------------------|-------------------------|-------------------------|----------------------|---------------|
|                     |              |                      |                     |                         |                         |                      |               |
| <b>Front Doors</b>  |              |                      | <b>Rear Doors</b>   |                         | <b>Split Rear Doors</b> |                      |               |
| <b>Vented Plexi</b> | <b>Plexi</b> | <b>25% Open Area</b> | <b>Fully Vented</b> | <b>Partially Vented</b> | <b>64% Open Area</b>    | <b>79% Open Area</b> | <b>Solid*</b> |
| DPVFD-44            | DPPFD-44     | DVPFD-44             | DFVRD-44            | DVRD-44                 | DSVRD-44                | DCLVRD-44            | DCRD-44       |

\*accepts rear door fan (KO-CRD-FAN) and vent (KO-CRD-VT) kits

## Power Distribution & Lighting

vertical and rackmount power and lighting available  
please see pgs. 64-79

## Vertical Lacer Strips - pg. 111

|  |   |   |
|--|---|---|
|  |   |   |
| <b>LACE-44LP</b> 44<br>space 3 1/2" wide<br>lacer strip, sold in<br>packs of 6 | <b>LACE-P</b> 45<br>space 2" wide<br>lacer strip, sold in<br>packs of 6 | <b>LACE-40-OP</b> 40<br>space 3/4" wide<br>lacer strip, sold in<br>packs of 6 |

## Copper Buss Bars

|  |   |
|--|---|
|  |   |
| <b>BB-40</b> 40<br>space 2" wide<br>copper<br>buss bar | <b>BB-44-1</b><br>44 space 1" wide<br>copper buss bar |

## Side Panels, Caster Base, Rackrail

|                    |                                    |                     |                            |
|--------------------|------------------------------------|---------------------|----------------------------|
|                    |                                    |                     |                            |
| <b>Rack Part #</b> | <b>Keylocked Side Panels, Pair</b> | <b>Caster Base*</b> | <b>Additional Rackrail</b> |
| DRK19-44-31        | SPN-44-312                         | CBS-DRK-31          | DRK19-RR44                 |
| DRK19-44-31K       | included                           | CBS-DRK-31          | DRK19-RR44                 |
| DRK19-44-31PRO     | SPN-44-312                         | CBS-DRK-31          | DRK19-RR44PRO**            |
| DRK19-44-36        | SPN-44-36                          | CBS-DRK-36          | DRK19-RR44                 |
| DRK19-44-36PRO     | SPN-44-36                          | CBS-DRK-36          | DRK19-RR44PRO**            |
| DRK19-44-42        | SPN-44-423                         | -                   | DRK19-RR44                 |
| DRK19-44-42PRO     | SPN-44-423                         | -                   | DRK19-RR44PRO**            |
| DRK23-44-31        | SPN-44-312                         | CBS-DRK-31          | DRK23-RR44                 |

\*1,300 lb. weight capacity \*\*cage nut style rackrail

## Panel Reducers, Ducts, Isolation Panel, Cable Management

|  |  |  |  |
|--|--|--|--|
|  |  |  |  |
| <b>23" to 19" Panel Width Reducers</b> | <b>DRK-44DUCT</b><br>add cable duct<br>when rear cable<br>management<br>is required,<br>single piece | <b>ISO-KOP</b><br>top or bottom mount<br>Electrical Isolation<br>Knockout Panel<br>features<br>non-conductive<br>EKO's to isolate<br>electrical conduit<br>from the rack<br>see pg. 31 | <b>TW12</b><br>Velcro® cable<br>management<br>straps, 8" long,<br>sold in packs<br>of 12 |
| <b>23-19-1</b> 1 space                 |  |  |  |
| <b>23-19-2</b> 2 spaces                |  |  |  |
| <b>23-19-3</b> 3 spaces                |  |  |  |
| <b>23-19-4</b> 4 spaces                |  |  |  |

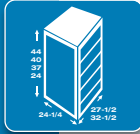

# WRK-SA Series Stand-Alone Rack Enclosures

## Wide Stand-Alone Rack for Large Cable Bundles and Superior Convective Cooling

Select a WRK-SA when mounting equipment that demands space for substantial cable bundles. Solid design and stylish beveled corners are ideal when aesthetics are an issue.

### Structural Features

- ✓ Fully welded construction provides:
  - Static load capacity, 10,000 lbs.
  - UL Listed load capacity, 2,500 lbs.
  - Seismic Certified load capacity, 900 lbs.
- ✓ 14-gauge steel tops and bottoms, 16-gauge seamless steel sides and 11-gauge thickness where the rail brackets are welded to the sides. Each model is equipped with laser cut 1/8" thick internal braces made from structural steel which enhance strength and provide more useable internal space
- ✓ Numbered rackspace increments speed equipment mounting
- ✓ Finished in a durable black textured powder coat

### Thermal Management

- ✓ Front and side ventilation locations optimize convective airflow
- ✓ Configurable open top accepts a number of options for thermal management
- ✓ Standard solid rear doors are configurable and accept a number of options for thermal management

### Cable Management

- ✓ Cable pass-throughs located in the face of the standard front and rear adjustable 11-gauge, 10-32 threaded, extra-wide rackrail facilitate the passing of cable from the face of equipment to the rear
- ✓ 1/2", 3/4", 1" and 1 1/2" electrical knockouts found on removable split rear plates, top knockout plate additionally includes UHF/VHF antenna knockouts
- ✓ Removable split rear plates allow cable bundles to be easily passed over or under the WRK-SA's standard key-locking rear door

### Code Compliancy

- ✓ Seismic Certified to the 1997 UBC and 2001 CBC Seismic Zone 4 and the 2000 IBC, 2003 IBC, 2002 ASCE Standard 7 and 2003 NFPA 5000 Seismic Use Group III lateral force requirements for protecting 900 lbs. of essential equipment in upper floor installations when used with optional MRK-Z4 seismic floor anchor brackets (see pg. 30) with an Ip value of 1.5
- ✓ Stud in base of rack facilitates the proper grounding and bonding of electronic equipment, as per NEBS and NEC standards
- ✓ UL Listed in the US and Canada



UL US LISTED  
 SEISMIC CERTIFIED  
 TIA/EIA COMPLIANT  
 A&E SPEC. # 96-05255A

optimized for passive and active thermal management

passive

active

see pgs. 80-87 for thermal management products

visit [middleatlantic.com](http://middleatlantic.com) for our thermal management white paper

rear top and bottom knockout plates are split to allow enhanced cable entry

split EKO plates remove for cable entry

also available as a presentation enclosure, see pg. 37

| 27 1/2" Outside Depth (25 3/4" Useable) Part # | 32 1/2" Outside Depth (30 3/4" Useable) Part # | Racking Height     | Overall Height | Recommended Power |
|--|--|--------------------|----------------|-------------------|
| WRK-44SA-27**                                  | WRK-44SA-32**                                  | 77" (44 space)     | 83 1/8"        | N P R T           |
| WRK-40SA-27                                    | WRK-40SA-32                                    | 70" (40 space)     | 76 1/8"        | N P T             |
| WRK-37SA-27                                    | WRK-37SA-32                                    | 64 3/4" (37 space) | 70 1/8"        | E G               |
| WRK-24SA-27                                    | WRK-24SA-32                                    | 42" (24 space)     | 48 1/8"        | E G               |

\*\*Available without rear door, suffix part number with 'LRD'. See pgs. 64-79 for complete list of power products.



# WRK-SA Series Stand-Alone Rack Enclosure Options

See pgs. 26-31 for more information.

**Top Options** most top options feature a removable 2 rackspace service plate



|   |  |   |  |  |  |  |   |
|---|--|---|--|--|--|--|---|
|   |  |   |  |  |  |  |   |
| <b>MW-ST</b><br>solid <b>MW-LVT</b><br>64% open<br>area <b>MW-VT</b> slot<br>pattern vented | <b>MW-10FT</b><br>(included) mounts one 10" fan<br><b>MW-10FT-550CFM</b><br>with fan <b>MW-10FT-FC</b><br>with fan + control | <b>MW-6FT</b><br>mounts three<br>6" fans<br><b>MW-6FT-660CFM</b><br>with fans | <b>MW-4FT</b><br>mounts four 4 1/2" fans<br><b>MW-4FT-380CFM</b><br>with fans <b>MW-4QFT-FC</b><br>with quiet fans + control | <b>MW-DT</b><br>duct cool<br>adapter<br>see pg. 87 | <b>MW-LA</b><br>accepts<br>6" and 12"<br>cable ladders | <b>MW-TR</b><br>top-mounted<br>rail option,<br>13 spaces | <b>BR2</b><br>2 space brush<br>grommet fits top<br>option opening |

## Door Options

| Rack Part # | Front Doors |        |               |               |              | Rear Doors    |                  | Split Rear Doors |           |
|-------------|-------------|--------|---------------|---------------|--------------|---------------|------------------|------------------|-----------|
|             | Solid       | Plexi  | 25% Open Area | 64% Open Area | Plexi Vented | 64% Open Area | Partially Vented | 79% Open Area    | Solid*    |
| WRK-44SA-xx | FD-44       | PFD-44 | VFD-44        | LVFD-44       | PVFD-44      | MW-LVRD-44    | MW-VRD-44        | MW-CLVRD-44      | MW-CRD-44 |
| WRK-40SA-xx | FD-40       | PFD-40 | VFD-40        | LVFD-40       | -            | -             | -                | -                | -         |
| WRK-37SA-xx | FD-37       | PFD-37 | VFD-37        | LVFD-37       | -            | -             | -                | -                | -         |
| WRK-24SA-xx | FD-24       | PFD-24 | VFD-24        | LVFD-24       | -            | -             | -                | -                | -         |

\*accepts rear door fan (KO-CRD-FAN) and vent (KO-CRD-VT) kits

## Door Knockout Panel Options

|          |        |            |         |
|----------|--------|------------|---------|
|          |        |            |         |
| KO-AWFP2 | KO-VT3 | KO-FILTER3 | KO-WSB3 |

standard solid rear doors are configurable for enhanced thermal management

## Power Distribution & Lighting

vertical and rackmount power and lighting available please see pgs. 64-79

## Vertical Lacer Strips - pg. 111

|   |  |  |
|---|--|--|
|   |  |  |
| <b>LACE-44LP</b> 44 space 3 1/2" wide lacer strip, sold in packs of 6 | <b>LACE-P</b> 45 space 2" wide lacer strip, sold in packs of 6 | <b>LACE-40-OP</b> 40 space 3/4" wide lacer strip, sold in packs of 6 |

## Additional Rail, Caster Bases, Inner Platform Base

| Rack Part # | Add'l 10-32 Threaded Rackrail | Add'l Cage Nut Rackrail | Commercial Grade Caster Base | Fine Floor Caster Base | Inner Platform Base |
|-------------|-------------------------------|-------------------------|------------------------------|------------------------|---------------------|
| WRK-44SA-27 | WRK-RR44                      | PROWRK-RR44             | CBS-WRK-27                   | CBS-WRK-27R            | BS-WRK-27           |
| WRK-40SA-27 | WRK-RR40                      | PROWRK-RR40             | CBS-WRK-27                   | CBS-WRK-27R            | BS-WRK-27           |
| WRK-37SA-27 | WRK-RR37                      | PROWRK-RR37             | CBS-WRK-27                   | CBS-WRK-27R            | BS-WRK-27           |
| WRK-24SA-27 | WRK-RR24                      | PROWRK-RR24             | CBS-WRK-27                   | CBS-WRK-27R            | BS-WRK-27           |
| WRK-44SA-32 | WRK-RR44                      | PROWRK-RR44             | CBS-WRK-32                   | CBS-WRK-32R            | BS-WRK-32           |
| WRK-40SA-32 | WRK-RR40                      | PROWRK-RR40             | CBS-WRK-32                   | CBS-WRK-32R            | BS-WRK-32           |
| WRK-37SA-32 | WRK-RR37                      | PROWRK-RR37             | CBS-WRK-32                   | CBS-WRK-32R            | BS-WRK-32           |
| WRK-24SA-32 | WRK-RR24                      | PROWRK-RR24             | CBS-WRK-32                   | CBS-WRK-32R            | BS-WRK-32           |

## Rack Base Templates

Use for pre-installation floor and anchor layout on multi-bay installations  
**WRK-TEMP-27** for 27" deep WRK-SAs  
**WRK-TEMP-32** for 32" deep WRK-SAs

## Work Surfaces - pg. 27



## Electrical Isolation Knockout Panel

**ISO-KOP** top or bottom mount Electrical Isolation Knockout Panel features non-conductive EKO's to isolate electrical conduit from the rack, see pg. 31

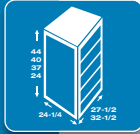

# WRK Series Gangable Rack Enclosures

## Wide Multi-Bay Rack Optimized for Large Cable Bundles

Choose a WRK when multiple racks need to be joined or when open sides are desirable for easy access to cables and components. Wide design is ideal when mounting equipment that demands space for substantial cable bundles.

### Structural Features

- ✓ Fully welded construction provides:
  - Static load capacity, 10,000 lbs.
  - UL Listed load capacity, 2,500 lbs.
  - Seismic Certified load capacity, 900 lbs.
- ✓ 14-gauge steel tops and bottoms, 16-gauge seamless steel sides and 11-gauge thickness where the rail brackets are welded to the sides. Each model is equipped with laser cut 1/8" thick internal braces made from structural steel which enhance strength and provide more useable internal space
- ✓ Numbered rackspace increments speed equipment mounting
- ✓ Finished in a durable black textured powder coat

### Thermal Management

- ✓ Configurable open top accepts a number of options for thermal management
- ✓ Standard solid rear doors are configurable and accept a number of options for thermal management

### Cable Management

- ✓ Cable pass-throughs located in the face of the standard front and rear adjustable 11-gauge, 10-32 threaded, extra-wide rackrail facilitate the passing of cable from the face of equipment to the rear
- ✓ 1/2", 3/4", 1" and 1 1/2" electrical knockouts found on removable split rear plates, top knockout plate additionally includes UHF/VHF antenna knockouts
- ✓ Removable split rear plates allow cable bundles to be easily passed over or under the WRK's standard key-locking rear door

### Code Compliancy

- ✓ Seismic Certified to the 1997 UBC and 2001 CBC Seismic Zone 4 and the 2000 IBC, 2003 IBC, 2002 ASCE Standard 7 and 2003 NFPA 5000 Seismic Use Group III lateral force requirements for protecting 900 lbs. of essential equipment in upper floor installations when used with optional WRK-Z4 seismic floor anchor brackets (see pg. 30) with an Ip value of 1.5
- ✓ Stud in base of rack facilitates the proper grounding and bonding of electronic equipment, as per NEBS and NEC standards
- ✓ UL Listed in the US and Canada

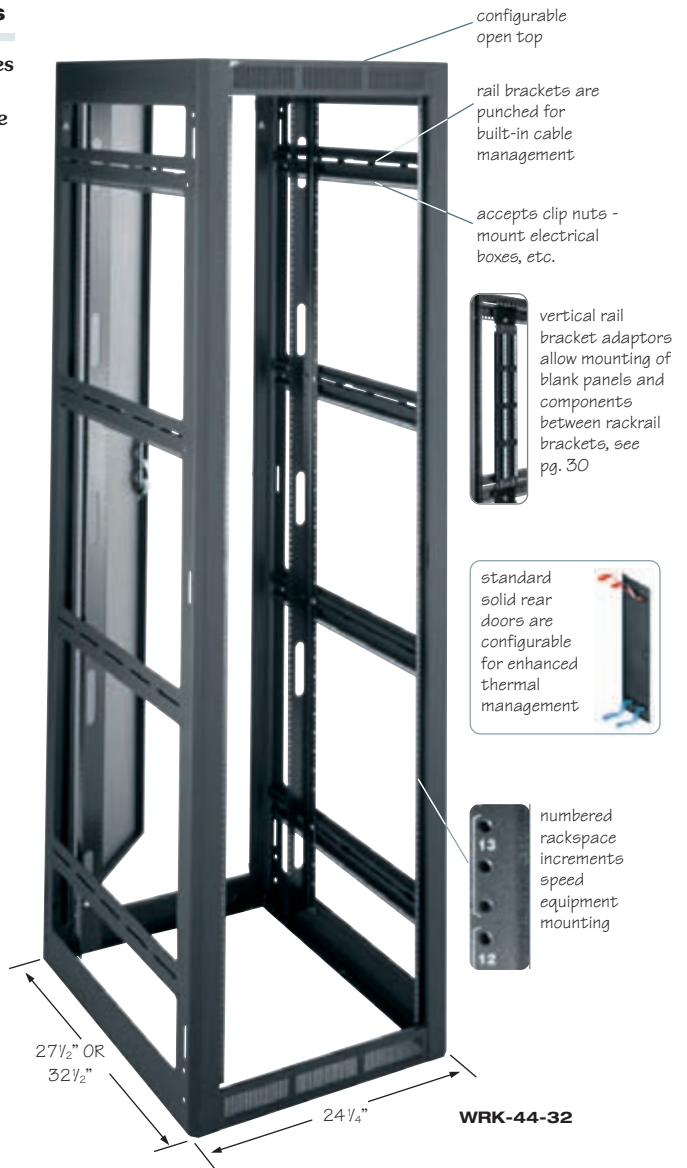

UL LISTED  
 SEISMIC CERTIFIED  
 TIME/AREA COMPLIANT  
 A&E SPEC. # 96-052G

optimized for passive and active thermal management

passive

see pgs. 80-87 for thermal management products

active

visit [middleatlantic.com](http://middleatlantic.com) for our thermal management white paper

rear top and bottom knockout plates are split to allow enhanced cable entry

split EKO plates remove for cable entry

| 27 1/2" Outside Depth (25 3/4" Useable) Part # | 32 1/2" Outside Depth (30 3/4" Useable) Part # | Racking Height     | Overall Height | Recommended Power |
|--|--|--------------------|----------------|-------------------|
| WRK-44-27**                                    | WRK-44-32**                                    | 77" (44 space)     | 83 7/8"        | N P R T           |
| WRK-40-27                                      | WRK-40-32                                      | 70" (40 space)     | 76 7/8"        | N P T             |
| WRK-37-27                                      | WRK-37-32                                      | 64 3/4" (37 space) | 70 7/8"        | E G               |
| WRK-24-27                                      | WRK-24-32                                      | 42" (24 space)     | 48 7/8"        | E G               |

\*\*Available without rear door, suffix part number with 'LRD'. See pgs. 64-79 for complete list of power products.



# WRK Series Gangable Rack Enclosure Options

See pgs. 26-31 for more information.

**Top Options** most top options feature a removable 2 rackspace service plate



|   |   |  |   |  |  |  |   |
|---|---|--|---|--|--|--|---|
|   |   |  |   |  |  |  |   |
| <b>MW-ST</b><br>solid <b>MW-LVT</b><br>64% open area <b>MW-VT</b> slot pattern vented | <b>MW-10FT</b><br>(included) mounts one 10" fan <b>MW-10FT-550CFM</b> with fan <b>MW-10FT-FC</b> with fan + control | <b>MW-6FT</b><br>mounts three 6" fans <b>MW-6FT-660CFM</b> with fans | <b>MW-4FT</b><br>mounts four 4 1/2" fans <b>MW-4FT-380CFM</b> with fans <b>MW-4QFT-FC</b> with quiet fans + control | <b>MW-DT</b><br>duct cool adapter see pg. 87 | <b>MW-LA</b><br>accepts 6" and 12" cable ladders | <b>MW-TR</b><br>top-mounted rail option, 13 spaces | <b>BR2</b><br>2 space brush grommet fits top option opening |

## Door Options

| Rack Part # | Front Doors |        |               |               |              | Rear Doors    |                  | Split Rear Doors |           |
|-------------|-------------|--------|---------------|---------------|--------------|---------------|------------------|------------------|-----------|
|             | Solid       | Plexi  | 25% Open Area | 64% Open Area | Plexi Vented | 64% Open Area | Partially Vented | 79% Open Area    | Solid*    |
| WRK-44-xx   | FD-44       | PFD-44 | VFD-44        | LVFD-44       | PVFD-44      | MW-LVRD-44    | MW-VRD-44        | MW-CLVRD-44      | MW-CRD-44 |
| WRK-40-xx   | FD-40       | PFD-40 | VFD-40        | LVFD-40       | -            | -             | -                | -                | -         |
| WRK-37-xx   | FD-37       | PFD-37 | VFD-37        | LVFD-37       | -            | -             | -                | -                | -         |
| WRK-24-xx   | FD-24       | PFD-24 | VFD-24        | LVFD-24       | -            | -             | -                | -                | -         |

\*accepts rear door fan (KO-CRD-FAN) and vent (KO-CRD-VT) kits

## Door Knockout Panel Options

|          |        |            |         |
|----------|--------|------------|---------|
|          |        |            |         |
| KO-AWFP2 | KO-VT3 | KO-FILTER3 | KO-WSB3 |

standard solid rear doors are configurable for enhanced thermal management

## Power Distribution & Lighting

vertical and rackmount power and lighting available please see pgs. 64-79

## Vertical Lacer Strips - pg. 111

|   |  |  |
|---|--|--|
|   |  |  |
| <b>LACE-44LP</b> 44 space 3 1/2" wide lacer strip, sold in packs of 6 | <b>LACE-P</b> 45 space 2" wide lacer strip, sold in packs of 6 | <b>LACE-40-OP</b> 40 space 3 1/4" wide lacer strip, sold in packs of 6 |

## Side Panels, Cable Chase, additional Rail, Caster Bases, Inner Platform Base \*custom cable chases available, please call for details

| Rack Part # | Keylocked Side Panels, Pair | Cable Chase* 4" Wide | Add'l 10-32 Threaded Rackrail | Add'l Cage Nut Rackrail | Commercial Grade Caster Base | Fine Floor Caster Base | Inner Platform Base |
|-------------|-----------------------------|----------------------|-------------------------------|-------------------------|------------------------------|------------------------|---------------------|
| WRK-44-27   | SPN-44-267                  | CC-44-267            | WRK-RR44                      | PROWRK-RR44             | CBS-WRK-27                   | CBS-WRK-27R            | BS-WRK-27           |
| WRK-40-27   | SPN-40-267                  | -                    | WRK-RR40                      | PROWRK-RR40             | CBS-WRK-27                   | CBS-WRK-27R            | BS-WRK-27           |
| WRK-37-27   | SPN-37-267                  | -                    | WRK-RR37                      | PROWRK-RR37             | CBS-WRK-27                   | CBS-WRK-27R            | BS-WRK-27           |
| WRK-24-27   | SPN-24-267                  | -                    | WRK-RR24                      | PROWRK-RR24             | CBS-WRK-27                   | CBS-WRK-27R            | BS-WRK-27           |
| WRK-44-32   | SPN-44-312                  | CC-44-312            | WRK-RR44                      | PROWRK-RR44             | CBS-WRK-32                   | CBS-WRK-32R            | BS-WRK-32           |
| WRK-40-32   | SPN-40-312                  | -                    | WRK-RR40                      | PROWRK-RR40             | CBS-WRK-32                   | CBS-WRK-32R            | BS-WRK-32           |
| WRK-37-32   | SPN-37-312                  | -                    | WRK-RR37                      | PROWRK-RR37             | CBS-WRK-32                   | CBS-WRK-32R            | BS-WRK-32           |
| WRK-24-32   | SPN-24-312                  | -                    | WRK-RR24                      | PROWRK-RR24             | CBS-WRK-32                   | CBS-WRK-32R            | BS-WRK-32           |

## Rack Base Templates

Use for floor layout on multi-bay installations **WRK-TEMP-27** for 27" deep WRK-SAs **WRK-TEMP-32** for 32 deep WRK-SAs

## Work Surfaces

see pg. 27

## Electrical Isolation Knockout Panel

**ISO-KOP** top or bottom mount Electrical Isolation Knockout Panel features non-conductive EKO's to isolate electrical conduit from the rack, see pg. 31

## RIB Series Riser Base

provides cable management below enclosures see pg. 26 for full details

## Rail Bracket Adaptors

allows for mounting of rack panels vertically between rackrail brackets on 44 sp. WRKs

| Part #    | Description |
|-----------|-------------|
| RBA-W44-1 | 1 space     |
| RBA-W44-2 | 2 space     |
| RBA-W44-3 | 3 space     |

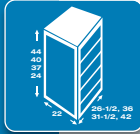

# MRK Series Gangable Rack Enclosures

## Narrow Design for Large-Scale Multi-Bay Jobs

Specify an MRK when multiple racks need to be joined, or when open sides are desirable for easy access to cables and components. Slim, space saving design is ideal when floor space is a consideration.

### Structural Features

- ✓ Fully welded construction provides:
  - Static load capacity, 10,000 lbs.
  - UL Listed load capacity, 2,500 lbs.
  - Seismic Certified load capacity, 900 lbs.
- ✓ 14-gauge steel tops and bottoms, 16-gauge seamless steel sides and 11-gauge thickness where the rail brackets are welded to the sides. Each model is equipped with laser cut 1/8" thick internal braces made from structural steel
- ✓ Standard front and rear adjustable 11-gauge, 10-32 threaded, wide rackrail with numbered rackspace increments to speed equipment mounting
- ✓ Racks gang together when fully loaded
- ✓ Finished in a durable black textured powder coat

### Thermal Management

- ✓ Configurable open top accepts a number of options
- ✓ Standard solid rear doors are configurable and accept a number of options for thermal management

### Cable Management

- ✓ Abundant lacing points throughout the interior facilitate cable management
- ✓ 1/2", 3/4", 1" and 1 1/2" electrical knockouts found on removable split rear plates, top knockout plate additionally includes UHF/VHF antenna knockouts
- ✓ Rail brackets are pre-punched for built-in cable management
- ✓ Removable split rear plates allow cable bundles to be easily passed over or under the MRK's standard key-locking rear door

### Code Compliancy

- ✓ Seismic Certified to the 1997 UBC and 2001 CBC Seismic Zone 4 and the 2000 IBC, 2003 IBC, 2002 ASCE Standard 7 and 2003 NFPA 5000 Seismic Use Group III lateral force requirements for protecting 900 lbs. of essential equipment in upper floor installations when used with optional MRK-Z4 seismic floor anchor brackets (see pg. 30) with an Ip value of 1.5
- ✓ OSHPD approved for fixed equipment anchorage in California healthcare facilities
- ✓ Stud in base of rack facilitates the proper grounding and bonding of electronic equipment, as per NEBS and NEC standards
- ✓ UL Listed in the US and Canada

UL US LISTED  
SEISMIC CERTIFIED  
OSHPD  
TIA/EIA COMPLIANT

A&E SPEC.  
# 96-039

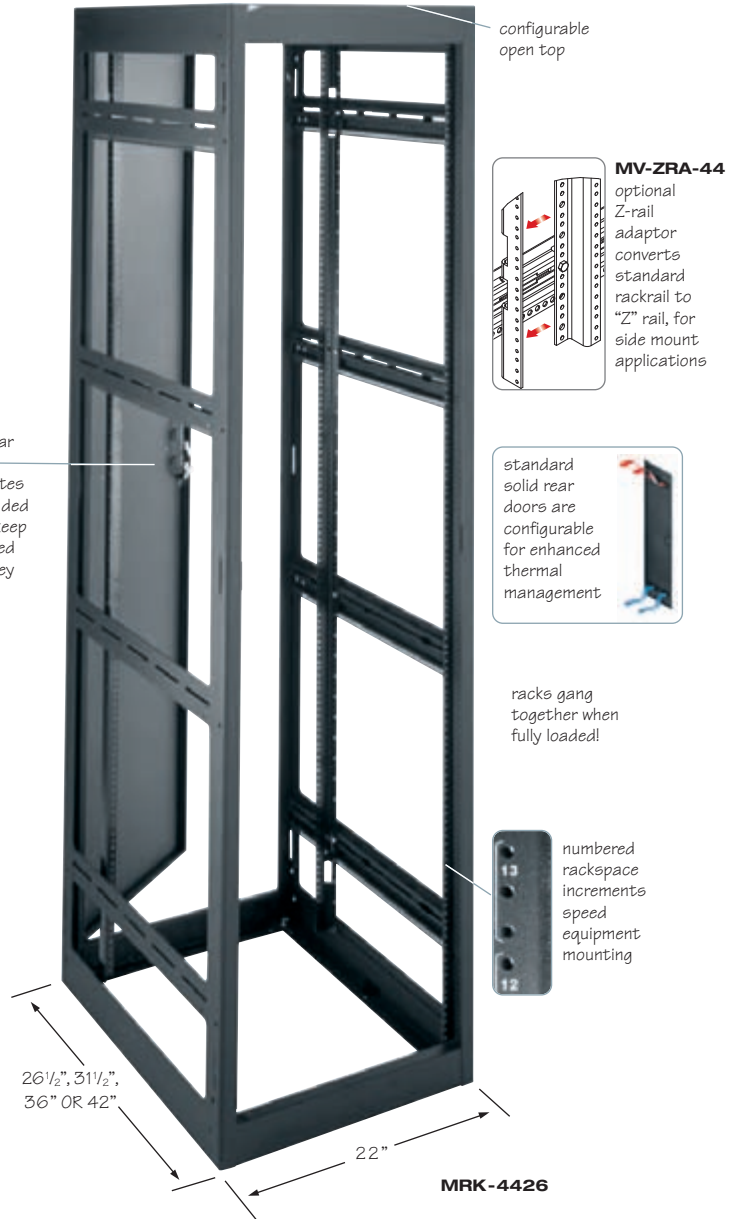

optimized for passive and active thermal management

passive

see pgs. 80-87 for thermal management products

active

visit middleatlantic.com for our thermal management white paper

rear top and bottom knockout plates are split to allow enhanced cable entry

split EKO plates remove for cable entry

| 26 1/2" Outside Depth (24" Useable) Part # | 31 1/2" Outside Depth (29" Useable) Part # | 36" Outside Depth (33 1/2" Useable) Part # | 42" Outside Depth (39 1/2" Useable) Part # | Racking Height     | Overall Height | Recommended Power |
|--|--|--|--|--------------------|----------------|-------------------|
| MRK-4426**                                 | MRK-4431**<br>MRK-4431PRO***               | MRK-4436**<br>MRK-4436PRO***               | MRK-4442**<br>MRK-4442PRO***               | 77" (44 space)     | 83 1/8"        | N P R T           |
| MRK-4026                                   | MRK-4031                                   | MRK-4036                                   | MRK-4042**                                 | 70" (40 space)     | 76 1/8"        | N P               |
| MRK-3726                                   | MRK-3731                                   | -  | -  | 64 3/4" (37 space) | 70 7/8"        | E G               |
| MRK-2426                                   | MRK-2431                                   | -  | -  | 42" (24 space)     | 48 1/8"        | E G               |

\*\*Available without rear door, suffix part number with 'LRD'. \*\*\*Configured with 2 pairs of cage nut style rackrail. See pgs. 64-79 for complete list of power products.

# MRK Series Configured Enclosures

See pgs. 26-31 for more information.

## Configured A/V Enclosures ship complete with:

### Thermal Management

- ✓ Integrated fan top, with proportional speed fan control
- ✓ Rear door bottom vent
- ✓ Vent blockers

### Cable Management

- ✓ Vertical lacer strip 3/4" width (LACE-OP Series)
- ✓ Horizontal lacer bars, four 'L' shaped straight and two 4" offset
- ✓ Velcro® cable management straps, 8" length, 12 qty

### Power Distribution

- ✓ 1 qty 20 Amp, 20 outlet power strip with cord (PDT-2020C-NS)

### Accessories

- ✓ Solid front and configurable rear door, locking
- ✓ 10-32 threaded rackscrews, 100 qty
- ✓ Leveling feet, 4 qty
- ✓ Side panels (MRK models with sides only)
- ✓ Ganging hardware (MRK open side models only)



| Description   | 26 1/2" Outside Depth (24" Useable) Part # | 31 1/2" Outside Depth (29" Useable) Part # | Racking Height | Overall Height |
|---------------|--|--|----------------|----------------|
| with sides    | MRK-4426-AV                                | MRK-4431-AV                                | 77" (44 space) | 83 1/8"        |
| without sides | MRK-4426-AV-AB                             | MRK-4431-AV-AB                             | 77" (44 space) | 83 1/8"        |

## Configured NVR/DVR Enclosures ship complete with:

### DVR Enclosure

- ✓ Two pairs 10-32 threaded rackrail
- ✓ 64% open area front door
- ✓ 79% open area split rear door
- ✓ 20 Amp, 20 outlet power strip with cord (PDT-2020C-NS)
- ✓ 64% open area top
- ✓ 3/4" width vertical lacer strip (LACE-44-OP)
- ✓ Horizontal lacer bars, four 'L' shaped straight and two 4" offset
- ✓ One each 1 space and 2 space brush grommet
- ✓ Velcro® cable management straps
- ✓ Rack screws, 100 quantity
- ✓ Side panels (models with sides only)
- ✓ Ganging hardware (open side models only)
- ✓ Leveling feet

### NVR Enclosure

- ✓ Two pairs cage nut style rackrail
- ✓ One pair of cage nut style Z-rail adaptors
- ✓ 64% open area front door
- ✓ 79% open area split rear door
- ✓ 20 Amp, 20 outlet power strip with cord (PDT-2020C-NS)
- ✓ Fully vented top
- ✓ 3/4" width vertical lacer strip (LACE-44-OP)
- ✓ Horizontal lacer bars, four 'L' shaped straight and two 4" offset
- ✓ One each 1 space and 2 space brush grommet
- ✓ Velcro® cable management straps
- ✓ 6 mm threaded cage nuts and rack screws, 100 quantity
- ✓ 10-32 threaded cage nuts and rack screws, 50 quantity
- ✓ Side panels (models with sides only)
- ✓ Ganging hardware (open side models only)
- ✓ Leveling feet

| Description   | Configured DVR Enclosure                   |  | Configured NVR Enclosure |                |
|---------------|--|--|--------------------------|----------------|
|               | 31 1/2" Outside Depth (29" Useable) Part # | 36" Outside Depth (33" Useable) Part # | Racking Height           | Overall Height |
| with sides    | MRK-4431-DVR                               | MRK-4436-NVR                           | 77" (44 space)           | 83 1/8"        |
| without sides | MRK-4431-DVR-AB                            | MRK-4436-NVR-AB                        | 77" (44 space)           | 83 1/8"        |

## Additional Rackrail

| Rack Part # | Add'l 10-32 Threaded Rackrail | Add'l Cage Nut Rackrail |
|-------------|-------------------------------|-------------------------|
| MRK-44xx    | MV-RR44                       | PROMRK-RR44             |
| MRK-40-xx   | MV-RR40                       | PROMRK-RR40             |
| MRK-37xx    | MV-RR37                       | PROMRK-RR37             |
| MRK-24xx    | MV-RR24                       | PROMRK-RR24             |

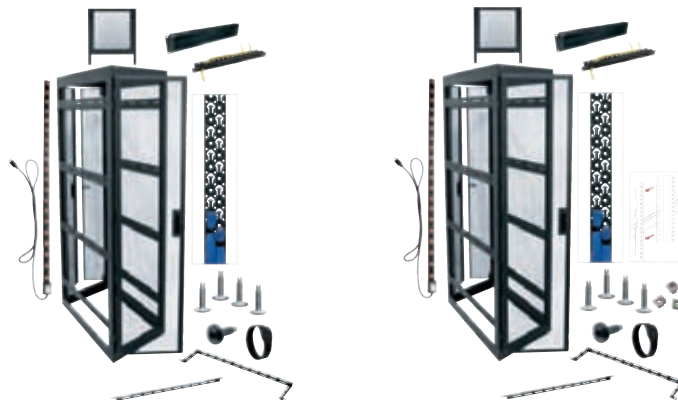

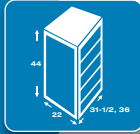

# VRK Series Video Rack Enclosure

## Narrow Multi-Bay Rack Optimized for Video Cable Bundles

Select a VRK when looking for a purpose engineered broadcast-standard 22" wide enclosure. Horizontal lacing bars are ideal for quick tie-and-slide lacing of video cable bundles.

### Structural Features

- ✓ Fully welded construction provides:
  - Static load capacity, 10,000 lbs.
  - UL Listed load capacity, 2,500 lbs.
  - Seismic Certified load capacity, 775 lbs.
- ✓ Laser knockouts for a one-gang electrical box are found in the vented bottom face, front and rear
- ✓ Superior strength results from the combination of laser cut 1/8" thick internal braces made from structural steel with 14-gauge steel top and bottom, 16-gauge steel sides and an 11-gauge structural thickness where rackrail brackets are welded to the sides
- ✓ Standard front and rear adjustable 11-gauge, 10-32 threaded rackrail with numbered rackspace increments to speed equipment mounting
- ✓ Racks gang together when fully loaded
- ✓ Finished in a durable black textured powder coat

### Thermal Management

- ✓ Configurable open top accepts a number of options for thermal management

### Cable Management

- ✓ Horizontal lacing bars made from 1/2" square tubing on 7" centers facilitate quick tie-and-slide cable lacing

### Code Compliancy

- ✓ Seismic Certified to the 1997 UBC and 2001 CBC Seismic Zone 4 and the 2000 IBC, 2003 IBC, 2002 ASCE Standard 7 and 2003 NFPA 5000 Seismic Use Group III lateral force requirements for protecting 775 lbs. of essential equipment in upper floor installations when used with optional VRK-Z4 seismic floor anchor brackets (see pg. 30) with an Ip value of 1.5
- ✓ Stud in base of rack facilitates proper grounding and bonding of electronic equipment, as per NEBS and NEC standards
- ✓ UL Listed in the US and Canada

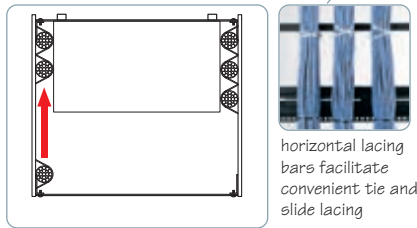
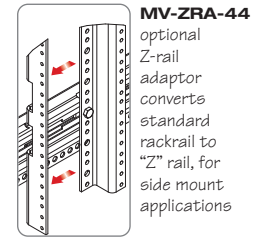
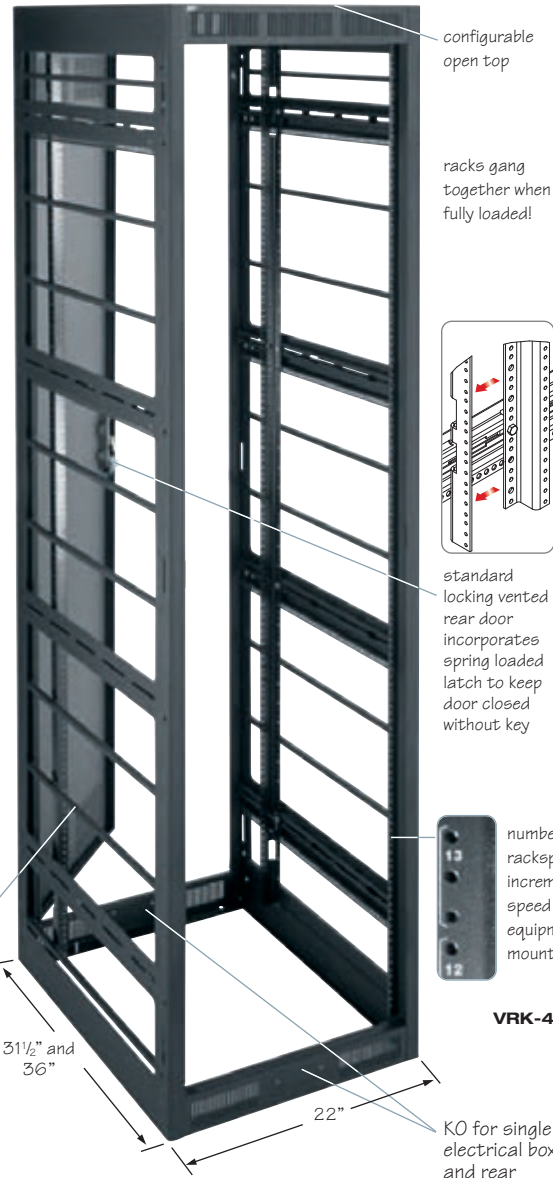

optimized for passive and active thermal management

passive

active

see pgs. 80-87 for thermal management products

visit [middleatlantic.com](http://middleatlantic.com) for our thermal management white paper

| Model #     | Description                               | Outside Depth | Useable Depth | Overall Height | Recommended Power |
|-------------|---|---------------|---------------|----------------|-------------------|
| VRK-44-31H* | 77" (44 space) video rack/horizontal bars | 31 1/2"       | 29"           | 83 1/8"        | N P R T           |
| VRK-44-36H* | 77" (44 space) video rack/horizontal bars | 36"           | 33 1/2"       | 83 1/8"        | N P R T           |

See pgs. 64-79 for complete list of power products.  
 \*Available without rear door, suffix part # with 'LRD'.

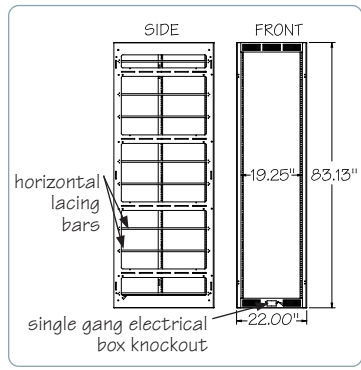

# VRK Series Video Rack Enclosure Options

See pgs. 26-31 for more information.

**Top Options** most top options feature a removable 2 rackspace service plate



|   |  |   |   |  |  |  |   |
|---|--|---|---|--|--|--|---|
|   |  |   |   |  |  |  |   |
| <b>MW-ST</b><br>solid <b>MW-LVT</b><br>64% open<br>area <b>MW-VT</b> slot<br>pattern vented | <b>MW-10FT</b><br>(included) mounts one 10" fan<br><b>MW-10FT-55OCFM</b><br>with fan <b>MW-10FT-FC</b><br>with fan + control | <b>MW-6FT</b><br>mounts three<br>6" fans<br><b>MW-6FT-66OCFM</b><br>with fans | <b>MW-4FT</b><br>mounts four 4½" fans<br><b>MW-4FT-38OCFM</b><br>with fans <b>MW-4QFT-FC</b><br>with quiet fans + control | <b>MW-DT</b><br>duct cool<br>adapter<br>see pg. 87 | <b>MW-LA</b><br>accepts<br>6" and 12"<br>cable ladders | <b>MW-TR</b><br>top-mounted<br>rail option,<br>13 spaces | <b>BR2</b><br>2 space brush<br>grommet fits top<br>option opening |

## Door Options

|                    |              |                      |                      |                     |                      |                         |                         |               |
|--------------------|--------------|----------------------|----------------------|---------------------|----------------------|-------------------------|-------------------------|---------------|
|                    |              |                      |                      |                     |                      |                         |                         |               |
| <b>Front Doors</b> |              |                      |                      |                     | <b>Rear Doors</b>    |                         | <b>Split Rear Doors</b> |               |
| <b>Solid</b>       | <b>Plexi</b> | <b>25% Open Area</b> | <b>64% Open Area</b> | <b>Plexi Vented</b> | <b>64% Open Area</b> | <b>Partially Vented</b> | <b>79% Open Area</b>    | <b>Solid*</b> |
| FD-44              | PFD-44       | VFD-44               | LVFD-44              | PVFD-44             | MW-LVRD-44           | MW-VRD-44               | MW-CLVRD-44             | MW-CRD-44     |

\*accepts rear door fan (KO-CRD-FAN) and vent (KO-CRD-VT) kits

## Power Distribution & Lighting

vertical and rackmount power and lighting available please see pgs. 64-79

## Vertical Lacer Strips - pg. 111

|   |   |  |
|---|---|--|
|   |   |  |
| <b>LACE-44LP</b><br>44 space 3½" wide<br>lacer strip, sold in<br>packs of 6 | <b>LACE-P</b><br>45 space 2" wide<br>lacer strip, sold in<br>packs of 6 | <b>LACE-40-OP</b><br>40 space 3¼" wide<br>lacer strip, sold in<br>packs of 6 |

## Copper Buss Bars

|   |   |
|---|---|
|   |   |
| <b>BB-40</b><br>40 space 2" wide<br>copper buss bar | <b>BB-44-1</b><br>44 space 1" wide<br>copper buss bar |

## Side Panels, Cable Chase, Rackrail

|                                    |                             |   |
|------------------------------------|-----------------------------|---|
|                                    |                             |   |
| <b>Keylocked Side Panels, Pair</b> | <b>Cable Chase* 4" Wide</b> | <b>Additional 10-32 Threaded Rackrail</b> |
| SPN-44-312                         | CC-44-312                   | MV-RR44                                   |
| SPN-44-36                          | CC-44-36                    | MV-RR44                                   |

\*Custom cable chases available, please call for details

## Seismic Certified Riser Bases

Seismic Certified riser bases available for raised floor environments in seismic zones, see pg. 26

## RIB Series Riser Base

provides cable management below enclosures see pg. 26 for full details

## Work Surfaces

see pg. 27

## Z-Rail Adaptor

**MV-ZRA-44**  
Z-Rail adaptor converts standard rackrail to "Z" rail for side mount applications, sold in pairs

## Rail Bracket Adaptors

allows for mounting of rack panels vertically between rackrail brackets on 44 sp. WRKs

| Part #    | Description |
|-----------|-------------|
| RBA-W44-1 | 1 space     |
| RBA-W44-2 | 2 space     |
| RBA-W44-3 | 3 space     |

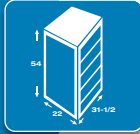

# VMRK Series Extra Tall Rack Enclosure

## Narrow Design Multi-Bay Rack with Extra Height

Choose a VMRK to take full advantage of ceiling height when additional racking space is required. Extra height and slim, space saving design are ideal when floor space is an issue and additional components are desired.

### Structural Features

- ✓ Fully welded construction provides:
  - Static load capacity, 10,000 lbs.
  - UL Listed load capacity, 2,500 lbs.
  - Seismic Certified load capacity, 600 lbs.
- ✓ Superior strength results from the combination of laser cut 1/8" thick internal braces made from structural steel with 14-gauge steel top and bottom, 16-gauge steel sides and an 11-gauge structural thickness where rackrail brackets are welded to the sides
- ✓ Standard front and rear adjustable 11-gauge, 10-32 threaded "Z-Rail" with numbered rackspace increments to speed equipment mounting
- ✓ Racks gang together when fully loaded
- ✓ Finished in a durable black textured powder coat

### Thermal Management

- ✓ Configurable open top accepts a number of options for thermal management

### Cable Management

- ✓ 1/2", 3/4", 1" and 1 1/2" electrical knockouts found on removable rear split plates, top knockout plate additionally includes UHF/VHF antenna knockouts
- ✓ Removable split rear plates allow cable bundles to be easily passed over or under the VMRK's standard key-locking rear door

### Code Compliancy

- ✓ Seismic Certified to the 1997 UBC and 2001 CBC Seismic Zone 4 and the 2000 IBC, 2003 IBC, 2002 ASCE Standard 7 and 2003 NFPA 5000 Seismic Use Group III lateral force requirements for protecting 600 lbs. of essential equipment in upper floor installations when used with optional MRK-Z4 seismic floor anchor brackets (see pg. 30) with an I<sub>p</sub> value of 1.5
- ✓ Stud in the base of rack facilitates proper grounding and bonding of electronic equipment, as per NEBS and NEC standards
- ✓ UL Listed in the US and Canada

UL US LISTED  
 SEISMIC CERTIFIED  
 TIA/EIA COMPLIANT  
 A&E SPEC. # 96-178

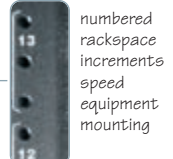

optimized for passive and active thermal management

passive

see pgs. 80-87 for thermal management products

active

visit [middleatlantic.com](http://middleatlantic.com) for our thermal management white paper

rear top and bottom knockout plates are split to allow enhanced cable entry

split EKO plates remove for cable entry

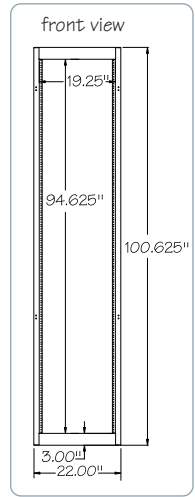

| Part #  | Racking Height     | Outside Depth | Useable Depth | Overall Height | Recommended Power |
|---------|--------------------|---------------|---------------|----------------|-------------------|
| VMRK-54 | 94 1/2" (54 space) | 31 1/2"       | 29"           | 100 5/8"       | N P T V           |

See pgs. 64-79 for complete list of power products.



# VMRK Extra Tall Rack Enclosure Options

See pgs. 26-31 for more information.

**Top Options** most top options feature a removable 2 rackspace service plate



|   |  |   |  |  |  |  |   |
|---|--|---|--|--|--|--|---|
|   |  |   |  |  |  |  |   |
| <b>MW-ST</b><br>solid <b>MW-LVT</b><br>64% open<br>area <b>MW-VT</b> slot<br>pattern vented | <b>MW-10FT</b><br>(included) mounts one 10" fan<br><b>MW-10FT-550CFM</b><br>with fan <b>MW-10FT-FC</b><br>with fan + control | <b>MW-6FT</b><br>mounts three<br>6" fans<br><b>MW-6FT-660CFM</b><br>with fans | <b>MW-4FT</b><br>mounts four 4 1/2" fans<br><b>MW-4FT-380CFM</b><br>with fans <b>MW-4QFT-FC</b><br>with quiet fans + control | <b>MW-DT</b><br>duct cool<br>adapter<br>see pg. 87 | <b>MW-LA</b><br>accepts<br>6" and 12"<br>cable ladders | <b>MW-TR</b><br>top-mounted<br>rail option,<br>13 spaces | <b>BR2</b><br>2 space brush<br>grommet fits top<br>option opening |

## Door Options, Side Panels, Additional Rail

|                         |                         |                                 |                                    |  |
|-------------------------|-------------------------|---------------------------------|------------------------------------|--|
|                         |                         |                                 |                                    |  |
| <b>Solid Front Door</b> | <b>Plexi Front Door</b> | <b>25% Open Area Front Door</b> | <b>Keylocked Side Panels, Pair</b> | <b>Additional Pair 10-32 Threaded Z-Rail</b> |
| FD-54                   | PFD-54                  | VFD-54                          | SPN-54-312                         | VRR-54                                       |

2 pieces per side, 4 pieces total

## Power Distribution & Lighting

vertical and rackmount power and lighting available please see pgs. 64-79

## Vertical Lacer Strips - pg. 111

|  |   |   |
|--|---|---|
|  |   |   |
| <b>LACE-44LP</b><br>44 space 3 1/2" wide<br>lacer strip, sold in<br>packs of 6 | <b>LACE-P</b><br>45 space 2" wide<br>lacer strip, sold in<br>packs of 6 | <b>LACE-40-OP</b><br>40 space 3/4" wide<br>lacer strip, sold in<br>packs of 6 |

## Copper Buss Bars

|   |   |
|---|---|
|   |   |
| <b>BB-40</b><br>40 space 2" wide<br>copper buss bar | <b>BB-44-1</b><br>44 space 1" wide<br>copper buss bar |

## Horizontal Lacer Bars - pg. 110

|   |   |   |  |   |   |   |   |   |  |
|---|---|---|--|---|---|---|---|---|--|
|   |   |   |  |   |   |   |   |   |  |
| <b>LBP-1.5</b><br>1.5" offset round<br>rod w/ flattened<br>ends, sold in<br>packs of 10 | <b>LBP-1R4</b><br>4" offset round<br>rod w/ flattened<br>ends, sold in<br>packs of 10 | <b>LBP-1S</b><br>rectangular<br>bar, sold in<br>packs of 10 | <b>LBP-1R</b><br>round<br>rod w/ flattened<br>ends, sold in<br>packs of 10 | <b>LBP-1A</b><br>"L" shaped<br>lacer bar,<br>sold in<br>packs of 10 | <b>LBP-2A</b><br>"L" shaped 2"<br>offset lacer<br>bar, sold in<br>packs of 10 | <b>LBP-4A</b><br>"L" shaped 4"<br>offset lacer<br>bar, sold in<br>packs of 10 | <b>LBP-6A</b><br>"L" shaped 6"<br>offset lacer<br>bar, sold in<br>packs of 10 | <b>UP1P</b><br>1 space<br>lacer panel<br>sold in packs<br>of 10 | <b>LBP-LTF</b><br>2 space<br>lacer panel<br>sold in packs<br>of 10 |

**IMPROVED STRENGTH**

## Electrical Isolation Knockout Panel

**ISO-KOP** top or bottom mount Electrical Isolation Knockout Panel features non-conductive EKO's to isolate electrical conduit from the rack, see pg. 31

## Rack Screws

pg. 132

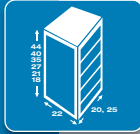

# ERK Series Stand-Alone/Gangable Rack Enclosure

## Aggressively Priced Stand-Alone Rack with Ganging Capabilities

Specify an ERK when economy is required and solid sides are preferable. Provides unparalleled quality at an aggressive price.

### Structural Features

- ✓ Fully welded construction provides:
  - Static load capacity, 10,000 lbs.
  - UL Listed load capacity, 2,500 lbs.
  - Seismic Certified load capacity, 600 lbs.
- ✓ Standard front adjustable 11-gauge, 10-32 threaded rackrail with numbered rackspace increments to speed equipment mounting
- ✓ Finished in a durable black textured powder coat

### Thermal Management

- ✓ Front and side ventilation locations optimize convection
- ✓ Configurable open tops on all 44, 40 and 35 space ERKs accept a number of options for thermal management while 27, 21 and 18 space models feature a solid top with 2 laser knockouts that accept 4½" fans
- ✓ Standard solid rear doors are configurable and accept a number of options for thermal management

### Cable Management

- ✓ ½", ¾", 1" and 1½" electrical knockouts found on removable split rear plates, top knockout plate additionally includes UHF/VHF antenna knockouts
- ✓ Multiple lacing points and slotted rail brackets add cable management convenience to ERKs
- ✓ Removable split rear plates allow cable bundles to be easily passed over or under the ERK's standard key-locking rear door

### Code Compliancy

- ✓ Seismic Certified to the 1997 UBC and 2001 CBC Seismic Zone 4 and the 2000 IBC, 2003 IBC, 2002 ASCE Standard 7 and 2003 NFPA 5000 Seismic Use Group III lateral force requirements for protecting 600 lbs. of essential equipment in upper floor installations when used with optional ERK-Z4 seismic floor anchor brackets (see pg. 30) with an Ip value of 1.5
- ✓ Stud in the base of rack facilitates proper grounding and bonding of electronic equipment, as per NEBS and NEC standards
- ✓ UL Listed in the US and Canada

ERKs feature 4" laser knockouts on sides, providing cable pass-through in addition to ganging holes, allowing for use in a multi-bay configuration without drilling (44, 40, 35 space models only), use GK4 4" ganging grommet kit to protect cables



ganging holes (laser knockouts)

optimized for passive and active thermal management

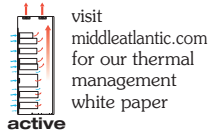
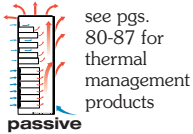

see pgs. 80-87 for thermal management products

visit [middleatlantic.com](http://middleatlantic.com) for our thermal management white paper

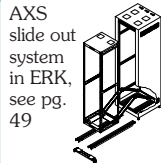

| 20" Outside Depth (18 <sup>15</sup> / <sub>32</sub> " Useable) Part # | 25" Outside Depth (23 <sup>15</sup> / <sub>32</sub> " Useable) Part # | Racking Height                              | Overall Height                   | Recommended Power |
|---|---|---|----------------------------------|-------------------|
| ERK-4420*   | ERK-4425*   | 77" (44 space)                              | 81 <sup>1</sup> / <sub>8</sub> " | N P R T           |
| ERK-4020*   | ERK-4025*   | 70" (40 space)                              | 74 <sup>1</sup> / <sub>8</sub> " | G N P             |
| ERK-3520*   | ERK-3525*   | 61 <sup>1</sup> / <sub>4</sub> " (35 space) | 65 <sup>3</sup> / <sub>8</sub> " | G J N             |
| ERK-2720*   | ERK-2725*   | 47 <sup>1</sup> / <sub>2</sub> " (27 space) | 51 <sup>3</sup> / <sub>8</sub> " | E G J             |
| ERK-2120*   | ERK-2125*   | 36 <sup>3</sup> / <sub>4</sub> " (21 space) | 40 <sup>7</sup> / <sub>8</sub> " | E G               |
| ERK-1820*   | ERK-1825*   | 31 <sup>1</sup> / <sub>2</sub> " (18 space) | 35 <sup>5</sup> / <sub>8</sub> " | C E               |

rear top and bottom knockout plates are split to allow enhanced cable entry

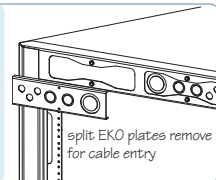





\*available without rear door, suffix part # with 'LRD'.





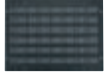



## ERK Series Options and Configured Enclosures

See pgs. 26-31 for more information.

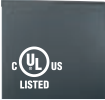
### Top Options (44, 50, 35 space models)

|   |   |  |  |   |   |
|---|---|--|--|---|---|
|  |  |                                     |  |    |  |
| <b>ERK-ST</b><br>solid  | <b>ERK-VT</b><br>vented   | <b>ERK-10FT</b><br>mounts one 10" fan<br><b>ERK-10FT-550CFM</b><br>with fan <b>ERK-10FT-FC</b><br>with fan + control | <b>ERK-6FT</b><br>mounts two 6" fans<br><b>ERK-6FT-440CFM</b><br>with fans         | <b>ERK-4FT</b><br>mounts three 4½" fans<br><b>ERK-4FT-285CFM</b><br>with fans <b>ERK-4QFT-FC</b><br>with quiet fans + control | <b>ERK-DT</b><br>duct cool<br>adapter<br>see pg. 87                                 |

### Door Options, Side Panels, Additional Rail

|   |   |   |   |   |   |                  |
|---|---|---|---|---|---|------------------|
|  |  |  |  |  |  |                  |
| <b>Rack Part #</b>  | <b>Front Doors</b>  |   |   |   |   | <b>Rear Door</b> |
|   | <b>Solid</b>  | <b>Plexi</b>  | <b>25% Open Area</b>  | <b>64% Open Area</b>  | <b>Plexi Vented</b>   | <b>Vented</b>    |
| ERK-44xx  | FD-44   | PFD-44  | VFD-44  | LVFD-44   | PVFD-44   | ERK-VRD-44       |
| ERK-40xx  | FD-40   | PFD-40  | VFD-40  | LVFD-40   | -   | ERK-VRD-40       |
| ERK-35xx  | FD-35   | PFD-35  | VFD-35  | LVFD-35   | -   | ERK-VRD-35       |
| ERK-27xx  | FD-27   | PFD-27  | VFD-27  | -   | -   | ERK-VRD-27       |
| ERK-21xx  | FD-21   | PFD-21  | VFD-21  | LVFD-21   | -   | ERK-VRD-21       |
| ERK-18xx  | FD-18   | PFD-18  | VFD-18  | LVFD-18   | -   | ERK-VRD-18       |

vented rear door, for ERKs ordered without rear door

### Additional Rackrail

|  |                                      |
|--|--------------------------------------|
|  |                                      |
| <b>Rack Part #</b>   | <b>Add'l 10-32 Threaded Rackrail</b> |
| ERK-44xx   | ERK-RR44                             |
| ERK-40-xx  | ERK-RR40                             |
| ERK-35xx   | ERK-RR35                             |
| ERK-27xx   | ERK-RR27                             |
| ERK-21xx   | ERK-RR21                             |
| ERK-18xx   | ERK-RR18                             |

### Configured A/V Enclosures ship complete with:

#### Thermal Management

- ✓ Integrated fan top
- ✓ Rear door bottom vent
- ✓ Vent blockers

#### Cable Management

- ✓ Vertical lacer strip ¾" width (LACE-OP Series)
- ✓ Horizontal lacer bars, four 'L' shaped straight and two 4" offset
- ✓ Velcro® cable management straps, 8" length, 12 qty

#### Power Distribution

- ✓ 1 qty 20 Amp, 20 outlet power strip with cord, 44 space enclosures (PDT-2020C-NS)
- ✓ 2 qty 20 Amp, 10 outlet power strip with cord, 35 and 40 space enclosures (PDT-1020C-NS)

#### Accessories

- ✓ Solid front and configurable rear door, locking
- ✓ 10-32 threaded rackscrews, 100 qty
- ✓ Leveling feet, 4 qty



| 25" Outside Depth (23 <sup>15</sup> / <sub>32</sub> " Useable) Part # | Racking Height  |
|---|-----------------|
| ERK-4425-AV   | 77" (44 space)  |
| ERK-4025-AV   | 70" (40 space)  |
| ERK-3525-AV   | 61¼" (35 space) |



# Raised Floor Enclosure Support System™

## Simplifies The Installation of Enclosures onto a Raised Floor or Slab

A&E SPEC. # 96-923

Time-saving and practical, the Raised Floor Enclosure Support System™ consists of 2½" high riser bases which provide the ability to perform field rough-in procedures prior to the arrival of the racks and enclosures. Also handy as a lower cable chase for passing cables between racks in multi-bay applications, riser bases feature ⅛" thick fully welded construction and an attractive black powder coat finish. Riser bases feature knockouts for passing cable between joined riser bases. Riser feet bring riser bases to a 12" height for use with raised floors. Raised floor support angles support floor tiles when used with riser bases and feet. Custom width, depth and height RIB Series riser bases are also available, please call for details.

| RIB Series Riser Bases Part # | # of Bays | Raise Floor Riser Feet Part # | Raised Floor Support Angles Part # | Accommodates                 |
|-------------------------------|-----------|-------------------------------|------------------------------------|------------------------------|
| RIB-1-WRK-27                  | 1         | VFEET-1-12                    | WANGLE-1                           | WRK 27" depth racks          |
| RIB-2-WRK-27                  | 2         | VFEET-2-12                    | WANGLE-2                           | WRK 27" depth racks          |
| RIB-3-WRK-27                  | 3         | VFEET-3-12                    | WANGLE-3                           | WRK 27" depth racks          |
| RIB-4-WRK-27                  | 4         | VFEET-4-12                    | WANGLE-4                           | WRK 27" depth racks          |
| RIB-5-WRK-27                  | 5         | VFEET-5-12                    | WANGLE-5                           | WRK 27" depth racks          |
| RIB-1-WRK-32                  | 1         | VFEET-1-12                    | WANGLE-1                           | WRK 32" depth racks          |
| RIB-2-WRK-32                  | 2         | VFEET-2-12                    | WANGLE-2                           | WRK 32" depth racks          |
| RIB-3-WRK-32                  | 3         | VFEET-3-12                    | WANGLE-3                           | WRK 32" depth racks          |
| RIB-4-WRK-32                  | 4         | VFEET-4-12                    | WANGLE-4                           | WRK 32" depth racks          |
| RIB-5-WRK-32                  | 5         | VFEET-5-12                    | WANGLE-5                           | WRK 32" depth racks          |
| <b>NEW</b> RIB-1-WMRK-36      | 1         | VFEET-1-12                    | WMANGLE-1-3642                     | WMRK 36" depth racks         |
| <b>NEW</b> RIB-2-WMRK-36      | 2         | VFEET-2-12                    | WMANGLE-2-3642                     | WMRK 36" depth racks         |
| <b>NEW</b> RIB-3-WMRK-36      | 3         | VFEET-3-12                    | WMANGLE-3-3642                     | WMRK 36" depth racks         |
| <b>NEW</b> RIB-1-WMRK-42      | 1         | VFEET-1-12                    | WMANGLE-1-3642                     | WMRK 42" depth racks         |
| <b>NEW</b> RIB-2-WMRK-42      | 2         | VFEET-2-12                    | WMANGLE-2-3642                     | WMRK 42" depth racks         |
| <b>NEW</b> RIB-3-WMRK-42      | 3         | VFEET-3-12                    | WMANGLE-3-3642                     | WMRK 42" depth racks         |
| <b>NEW</b> RIB-1-WMRK-48      | 1         | VFEET-1-12                    | WMANGLE-1-48                       | WMRK 48" depth racks         |
| <b>NEW</b> RIB-2-WMRK-48      | 2         | VFEET-2-12                    | WMANGLE-2-48                       | WMRK 48" depth racks         |
| <b>NEW</b> RIB-3-WMRK-48      | 3         | VFEET-3-12                    | WMANGLE-3-48                       | WMRK 48" depth racks         |
| RIB-1-MRK-26                  | 1         | VFEET-1-12                    | ANGLE-1                            | MRK 26" depth racks          |
| RIB-2-MRK-26                  | 2         | VFEET-2-12                    | ANGLE-2                            | MRK 26" depth racks          |
| RIB-3-MRK-26                  | 3         | VFEET-3-12                    | ANGLE-3                            | MRK 26" depth racks          |
| RIB-4-MRK-26                  | 4         | VFEET-4-12                    | ANGLE-4                            | MRK 26" depth racks          |
| RIB-5-MRK-26                  | 5         | VFEET-5-12                    | ANGLE-5                            | MRK 26" depth racks          |
| RIB-1-MRK-31                  | 1         | VFEET-1-12                    | ANGLE-1                            | MRK/VRK/VMRK 31" depth racks |
| RIB-2-MRK-31                  | 2         | VFEET-2-12                    | ANGLE-2                            | MRK/VRK/VMRK 31" depth racks |
| RIB-3-MRK-31                  | 3         | VFEET-3-12                    | ANGLE-3                            | MRK/VRK/VMRK 31" depth racks |
| RIB-4-MRK-31                  | 4         | VFEET-4-12                    | ANGLE-4                            | MRK/VRK/VMRK 31" depth racks |
| RIB-5-MRK-31                  | 5         | VFEET-5-12                    | ANGLE-5                            | MRK/VRK/VMRK 31" depth racks |
| RIB-1-MRK-36                  | 1         | VFEET-1-12                    | ANGLE-1-36                         | MRK/VRK 36" depth racks      |
| RIB-2-MRK-36                  | 2         | VFEET-2-12                    | ANGLE-2-36                         | MRK/VRK 36" depth racks      |
| RIB-3-MRK-36                  | 3         | VFEET-3-12                    | ANGLE-3-36                         | MRK/VRK 36" depth racks      |
| RIB-4-MRK-36                  | 4         | VFEET-4-12                    | ANGLE-4-36                         | MRK/VRK 36" depth racks      |
| RIB-5-MRK-36                  | 5         | VFEET-5-12                    | ANGLE-5-36                         | MRK/VRK 36" depth racks      |
| RIB-1-MRK-42                  | 1         | VFEET-1-12                    | ANGLE-1-42                         | MRK 42" depth racks          |
| RIB-2-MRK-42                  | 2         | VFEET-2-12                    | ANGLE-2-42                         | MRK 42" depth racks          |
| RIB-3-MRK-42                  | 3         | VFEET-3-12                    | ANGLE-3-42                         | MRK 42" depth racks          |
| RIB-1-DRK-31                  | 1         | VFEET-1-12                    | DANGLE-1-31                        | DRK 31" depth racks          |
| RIB-2-DRK-31                  | 2         | VFEET-2-12                    | DANGLE-2-31                        | DRK 31" depth racks          |
| RIB-3-DRK-31                  | 3         | VFEET-3-12                    | DANGLE-3-31                        | DRK 31" depth racks          |
| RIB-1-DRK-36                  | 1         | VFEET-1-12                    | DANGLE-1-3642                      | DRK 36" depth racks          |
| RIB-2-DRK-36                  | 2         | VFEET-2-12                    | DANGLE-2-3642                      | DRK 36" depth racks          |
| RIB-3-DRK-36                  | 3         | VFEET-3-12                    | DANGLE-3-3642                      | DRK 36" depth racks          |
| RIB-1-DRK-42                  | 1         | VFEET-1-12                    | DANGLE-1-3642                      | DRK 42" depth racks          |
| RIB-2-DRK-42                  | 2         | VFEET-2-12                    | DANGLE-2-3642                      | DRK 42" depth racks          |
| RIB-3-DRK-42                  | 3         | VFEET-3-12                    | DANGLE-3-3642                      | DRK 42" depth racks          |

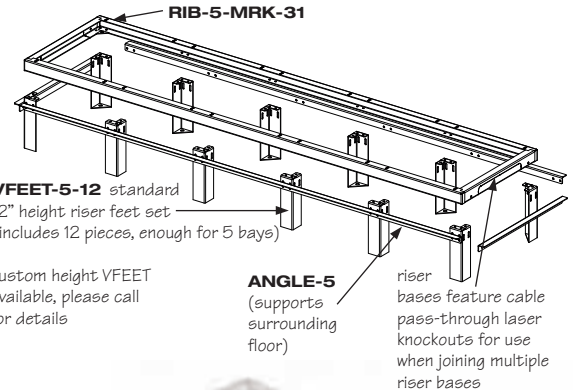

**Complete Raised Floor Enclosure Support System™** shown in typical raised floor installation

example of riser base in a raised floor installation



**RIB Series Riser Base** shown with MRK racks and custom cable chase

accommodates WRK, WMRK, MRK, DRK, VRK and VMRK Series racks and enclosures





## SRB Series Seismic Certified Riser Bases

SEISMIC CERTIFIED

A&E SPEC. # 96-01027

Designed to provide the same cable management facilities as our standard riser bases, but in zones of high seismicity, the SRB Series seismic certified riser bases have been rigorously tested to satisfy the 1997 UBC and 2001 CBC Seismic Zone 4 and the 2000 IBC, 2003 IBC, 2002 ASCE Standard 7 and 2003 NFPA 5000 Seismic Use Group III lateral force requirements for protecting 1,000 lbs. (1 bay), 1,500 lbs. (2 bays) or 2,250 lbs. (3 bays) of essential equipment in upper floor installations when used with optional MRK-Z4 or VRK-Z4 seismic floor anchor brackets (see pg. 30) with an  $I_p$  value of 1.5. With standard 24" height (custom heights available upon request), these riser bases are constructed of substantial 11-gauge steel. Accepts standard angles (pg. 26) to support surrounding raised floor tiles. Available for select enclosures, these riser bases require the use of seismic brackets (see below for part #s).

| Part #         | Description      | Accommodates                               | Seismic Brackets, 1 Set Required Per Rack |
|----------------|------------------|--|---|
| SRB-1-MRK-3124 | 1 bay riser base | MRK 31" depth racks<br>VRK 31" depth racks | MRK-Z4<br>VRK-Z4                          |
| SRB-2-MRK-3124 | 2 bay riser base | MRK 31" depth racks<br>VRK 31" depth racks | MRK-Z4<br>VRK-Z4                          |
| SRB-3-MRK-3124 | 3 bay riser base | MRK 31" depth racks<br>VRK 31" depth racks | MRK-Z4<br>VRK-Z4                          |
| SRB-1-MRK-3624 | 1 bay riser base | MRK 36" depth racks<br>VRK 36" depth racks | MRK-Z4<br>VRK-Z4                          |
| SRB-2-MRK-3624 | 2 bay riser base | MRK 36" depth racks<br>VRK 36" depth racks | MRK-Z4<br>VRK-Z4                          |
| SRB-3-MRK-3624 | 3 bay riser base | MRK 36" depth racks<br>VRK 36" depth racks | MRK-Z4<br>VRK-Z4                          |

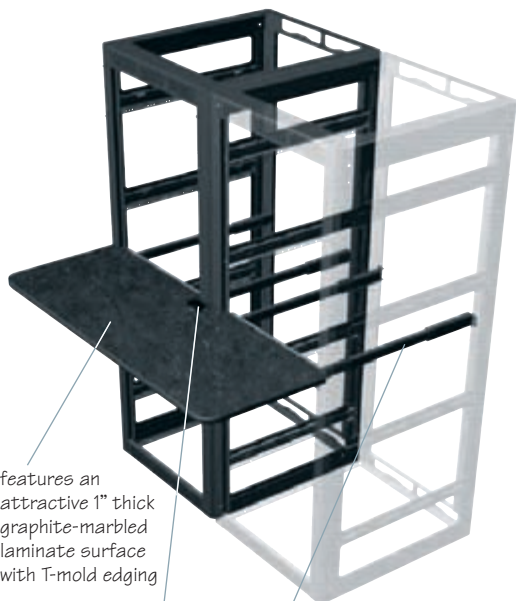

features an attractive 1" thick graphite-marbled laminate surface with T-mold edging

cable pass-through grommet provides effective cable management for laptops, computer keyboards, etc.

sturdy steel tubes attach to both the front and rear rackrail in each rack bay & extend beneath each work surface to provide support



**BR1** one rackspace brush grommet panel available for clean, organized cable entry, see pg. 112

## Multi-Bay Laminate Work Surfaces

A&E SPEC. # 96-957

Designed to provide an ergonomic work space, work surfaces are available for select WRK, MRK and VRK Series enclosures. Offered in two, three, and four-bay sizes to span multiple ganged racks, these shelves feature an attractive 1" thick graphite-marbled laminate surface with a durable black T-mold edging. The supplied mounting system consists of sturdy steel tubes that attach to both the front and rear rackrail in each rack bay and extend beneath each work surface, providing support. Additionally, each work surface includes cable pass-through with grommets providing effective cable management for laptops, computer keyboards, etc. Each work surface requires the use of two front and two rear rackspace. Custom sizes available, please call for details.

| 18" Shelf Depth Part # | 24" Shelf Depth Part # | Span  | Fits                   |
|------------------------|------------------------|-------|------------------------|
| WS2-M26-18             | WS2-M26-24             | 2 bay | MRK 26" deep racks     |
| WS3-M26-18             | WS3-M26-24             | 3 bay | MRK 26" deep racks     |
| WS4-M26-18             | WS4-M26-24             | 4 bay | MRK 26" deep racks     |
| WS2-M31-18             | WS2-M31-24             | 2 bay | MRK/VRK 31" deep racks |
| WS3-M31-18             | WS3-M31-24             | 3 bay | MRK/VRK 31" deep racks |
| WS4-M31-18             | WS4-M31-24             | 4 bay | MRK/VRK 31" deep racks |
| WS2-W27-18             | WS2-W27-24             | 2 bay | WRK 27" deep racks     |
| WS3-W27-18             | WS3-W27-24             | 3 bay | WRK 27" deep racks     |
| WS4-W27-18             | WS4-W27-24             | 4 bay | WRK 27" deep racks     |
| WS2-W32-18             | WS2-W32-24             | 2 bay | WRK 32" deep racks     |
| WS3-W32-18             | WS3-W32-24             | 3 bay | WRK 32" deep racks     |
| WS4-W32-18             | WS4-W32-24             | 4 bay | WRK 32" deep racks     |

NOTE: caster bases are not recommended for use on racks with work surfaces



# Universal Enclosure Options

## Top Options

Top options accept 4½", 6", or 10" fans for active thermal management. Adapter top option allows use with Duct Cool for active direct venting of rack, see pg. 87. Vented pagoda tops maintain enclosure temperatures through natural convection while minimizing the amount of dust and debris that can fall into the rack, and adds 1½" to the top of the rack. Solid, slot pattern vented, large perf vented and cable ladder adapter tops also available.

| Fits WRK, MRK, VRK, VMRK, DRK Part # | Fits WMRK, ERK, SCRK Part #* | Style   |
|--------------------------------------|------------------------------|---|
| MW-4FT                               | ERK-4FT*                     | mounts four 4½" fans (MW-4FT) or three 4½" fans (ERK-4FT) |
| MW-6FT                               | ERK-6FT                      | mounts three 6" fans (MW-6FT) or two 6" fans (ERK-6FT)    |
| MW-10FT                              | ERK-10FT*                    | mounts one 10" fan  |
| MW-VT                                | ERK-VT*                      | slot pattern vented                                       |
| <b>NEW</b> MW-DT                     | ERK-DT                       | duct cool adapter   |
| MW-LVT                               | -                            | vented, 64% open area                                     |
| MW-ST                                | ERK-ST*                      | solid   |
| MW-LA                                | -                            | accepts 6", 9" and 12" cable ladders                      |
| MV-PVTxx                             | -                            | vented pagoda top, MRK, VRK, VMRK only                    |

\*NOTE: black finish is standard, for granite gray finish suffix w/ 'GY', for light gray suffix w/ 'LG'. xx = depth of MRK, VRK & VMRK only (26", 31", 36" or 42").

## Integrated Fan Tops

Save time with Integrated Fan Tops! Ships assembled. Integrated fan tops include 4½", 6" or 10" fans, fan guards and optional proportional speed fan controller that increases fan life, reduces noise and maintenance!

| Part #           | # of Fans            | Fan Controller | Fits                       | Free Air CFM |
|------------------|----------------------|----------------|----------------------------|--------------|
| MW-4QFT-FC       | four 4½" quiet fans  | included       | MRK, DRK, VRK, VMRK Series | 200          |
| MW-10FT-FC       | one 10" fan          | included       | MRK, DRK, VRK, VMRK Series | 550          |
| MW-4FT-380CFM    | four 4½" fans        | optional       | MRK, DRK, VRK, VMRK Series | 380          |
| MW-6FT-660CFM    | three 6" fans        | optional       | MRK, DRK, VRK, VMRK Series | 660          |
| MW-10FT-550CFM   | one 10" fan          | optional       | MRK, DRK, VRK, VMRK Series | 550          |
| ERK-4QFT-FC*     | three 4½" quiet fans | included       | WMRK, ERK, SCRK Series     | 150          |
| ERK-10FT-FC*     | one 10" fan          | included       | WMRK, ERK, SCRK Series     | 550          |
| ERK-4FT-285CFM*  | three 4½" fans       | optional       | WMRK, ERK, SCRK Series     | 285          |
| ERK-6FT-440CFM*  | two 6" fans          | optional       | WMRK, ERK, SCRK Series     | 440          |
| ERK-10FT-550CFM* | one 10" fan          | optional       | WMRK, ERK, SCRK Series     | 550          |

\*NOTE: black finish is standard, for granite gray finish suffix with 'GY', for light gray suffix with 'LG'.

## Universal Side Panels

SPN Series side panels fit all WRK, MRK, VRK, VMRK, and DRK Series enclosures. (Easily lift on and off and include an internal locking kit.) Solid design, with stylish beveled corners that match the aesthetics of the enclosure. Black textured powder coat finish. Sold in pairs.

| Part #     | Fits WRK, MRK, VRK, VMRK, DRK | Part #     | Fits WRK, MRK, VRK, VMRK, DRK |
|------------|-------------------------------|------------|-------------------------------|
| SPN-54-312 | fits VMRK-54 only (4 pcs.)    | SPN-24-312 | 24 space 31" and 32" deep     |
| SPN-44-36  | 44 space 36" deep             | SPN-44-267 | 44 space 26" and 27" deep     |
| SPN-44-423 | 44 space 42" deep (4 pcs.)    | SPN-40-267 | 40 space 26" and 27" deep     |
| SPN-44-312 | 44 space 31" and 32" deep     | SPN-37-267 | 37 space 26" and 27" deep     |
| SPN-40-312 | 40 space 31" and 32" deep     | SPN-24-267 | 24 space 26" and 27" deep     |
| SPN-37-312 | 37 space 31" and 32" deep     |            |                               |

\*NOTE: Each side panel adds 5/8" to overall width.

## Ganging Hardware

Time-saving ganging hardware provides easy field alignment & joining of multi-bay enclosures. Available hardware includes drift pins, ½" magnetized sockets and enough 5/16" flange nuts & bolts to gang up to 10 racks or consoles.

### Touch-Up Paint

Touch-up paint is ideal for small nicks incurred during and after installation. Includes paint and applicator.

| Part #  | Description                                   |
|---------|---|
| DRIFT   | set of two tapered drift pins                 |
| MAG-½   | set of two ½" magnetic sockets                |
| GANG-10 | 5/16" nuts/bolts to gang 10 racks or consoles |

| Part #  | Description                   |
|---------|-------------------------------|
| WRINKLE | black textured touch-up paint |
| PUT     | putty textured touch-up paint |
| GY      | granite gray touch-up paint   |
| LG      | light gray touch-up paint     |

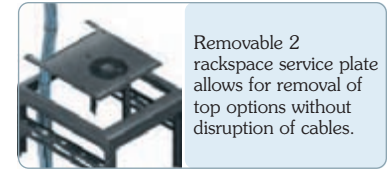

Removable 2 rackspace service plate allows for removal of top options without disruption of cables.

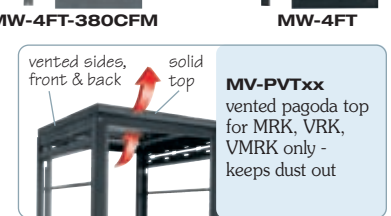

vented sides, front & back  
solid top

MV-PVTxx vented pagoda top for MRK, VRK, VMRK only - keeps dust out

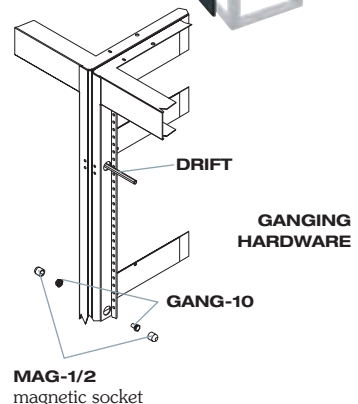

# Universal Enclosure Options



metal hinge provides front door mounting without the need for equipment removal



## Universal Locking Front Doors

Offered in lightly smoked plexi, vented, fully vented, vented plexi and solid configurations. Beveled corners provide a stylish modern appearance while hinging either left or right. VFD Series vented doors have 25% open area; LVFD Series fully vented doors have 64% open area. Black textured powder coat finish. Includes keylock.

| Part # (Fits WRK/MRK/VRK/VMRK/ERK/DWR/SR) |            |                    |                    |                   | # of Rackspace |
|---|------------|--------------------|--------------------|-------------------|----------------|
| Solid Door                                | Plexi Door | 25% Open Area Door | 64% Open Area Door | Vented Plexi Door |                |
| FD-54                                     | PFD-54     | VFD-54             | -                  | -                 | 54             |
| FD-46                                     | PFD-46     | VFD-46             | LVFD-46            | -                 | 46             |
| FD-44                                     | PFD-44     | VFD-44             | LVFD-44            | PVFD-44           | 44             |
| FD-40                                     | PFD-40     | VFD-40             | LVFD-40            | -                 | 40             |
| FD-37                                     | PFD-37     | VFD-37             | LVFD-37            | -                 | 37             |
| FD-35                                     | PFD-35     | VFD-35             | LVFD-35*           | -                 | 35             |
| FD-27                                     | PFD-27     | VFD-27             | -                  | -                 | 27             |
| FD-24                                     | PFD-24     | VFD-24             | LVFD-24*           | -                 | 24             |
| FD-21                                     | PFD-21     | VFD-21             | LVFD-21*           | -                 | 21             |
| FD-18                                     | PFD-18     | VFD-18             | LVFD-18*           | -                 | 18             |
| FD-16                                     | PFD-16     | VFD-16             | LVFD-16*           | -                 | 16             |
| FD-15                                     | PFD-15     | VFD-15             | -                  | -                 | 15             |
| FD-12                                     | PFD-12     | VFD-12             | LVFD-12*           | -                 | 12             |
| FD-10                                     | PFD-10     | VFD-10             | LVFD-10*           | -                 | 10             |

\*NOTE: black finish is standard, for granite gray finish suffix with 'GY'.

## Universal Vented Rear Doors

Substitute a vented rear door for a solid rear door in selected sizes. Black textured powder coat finish. See price list for racks available less rear door (LRD). Fully vented rear doors have 64% open area. Split rear doors with 3 point latch offer 79% open area and require less floor space when accessing rear equipment connections. New actively cooled rear doors feature positionable fans and have a 1,320 CFM rating.



fully vented split rear door saves space when working behind the rack



| Top & Bottom Vented Door Fits WRK, MRK, VRK Series Part # | 79% Open Area Split Rear Door Fits WRK, MRK, VRK Series Part # | 64% Open Area Door Fits WRK, MRK, VRK Series Part # | Solid Split Rear Door Fits WRK, MRK, VRK Series Part # | Actively Cooled Rear Doors Fits WRK, MRK, VRK Series Part # | Top & Bottom Vented Door Fits ERK Series Part # | # of Rackspace |
|---|--|---|--|---|---|----------------|
| MW-VRD-44   | MW-CLVRD-44  | MW-LVRD-44  | MW-CRD-44*   | MW-CFRD-44  | ERK-VRD-44                                      | 44             |
| -   | -  | MW-LVRD-40  | -  | -   | ERK-VRD-40                                      | 40             |
| -   | -  | -   | -  | -   | ERK-VRD-35                                      | 35             |
| -   | -  | -   | -  | -   | ERK-VRD-27                                      | 27             |
| -   | -  | -   | -  | -   | ERK-VRD-21                                      | 21             |
| -   | -  | -   | -  | -   | ERK-VRD-18                                      | 18             |

\*accepts rear door fan (KO-CRD-FAN) and vent (KO-CRD-VT) kits

## Door Latch

Replace keylocks with user-installed latches when security is not required. Can be used on all doors.



Part #  
LATCH

## Additional Keys

Set of 2 replacement keys.

| Part #  | Fits   |
|---------|--|
| SFD-KEY | front door locks   |
| SRD-KEY | rear door/side panel/center section locks, security door locks |
| ACC-KEY | DLBX, VLBX, LBX, rackmount storage, security cover locks       |

## Document Pocket

Store wiring diagrams, schematics, and other vital documents in this convenient steel holder. Fits rear doors of all Middle Atlantic Products racks and enclosures. Flush mounting studs included, black powder coat finish.



Part #  
DOC

## Door/Status Sensor

Mounts to any Middle Atlantic Products front and rear doors, and provides contact closure notification at door open/close events. Requires connection to system that senses contact closure.

| Part # | Quantity |
|--------|----------|
| DCS    | 1        |
| DCS-10 | 10       |

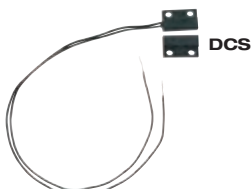



# Universal Enclosure Options

## Inner Platform Base

Provides a handy platform, flush w/ bottom rackspace, for supporting heavy equipment and mounting electrical boxes. Fits inside rack. See chart below for part #s.

## Caster Base

With a 1,300 lb. weight capacity, our commercial grade caster bases are equipped with heavy duty non-locking 3" swivel wheels and are UL Listed in the US and Canada. Fine floor caster bases available, with a 700 lb. weight capacity. Each base comes with its wheels preinstalled to save time, fits inside rack, and raises total rack height only 5/16". (ERK caster bases raise rack height by 4".) Caster base works with LF leveling feet, see pg. 31. NOTE: Inner platform base and caster base do not fit VMRK-54 and VRK-44-31H racks.

A&E SPEC. # 96-936



| Commercial Grade Caster Base Part # | Fine Floor Caster Base Part # | Inner Platform Base Part # | Fits         |
|-------------------------------------|-------------------------------|----------------------------|--------------|
| CBS-WRK-32                          | CBS-WRK-32R                   | BS-WRK-32                  | WRK 32" deep |
| CBS-WRK-27                          | CBS-WRK-27R                   | BS-WRK-27                  | WRK 27" deep |
| -                                   | -                             | BS-MRK-42                  | MRK 42" deep |
| CBS-MRK-36                          | CBS-MRK-36R                   | BS-MRK-36                  | MRK 36" deep |
| CBS-MRK-31                          | CBS-MRK-31R                   | BS-MRK-31                  | MRK 31" deep |
| CBS-MRK-26                          | CBS-MRK-26R                   | BS-MRK-26                  | MRK 26" deep |
| CBS-DRK-31                          | -                             | -                          | DRK 31" deep |
| CBS-DRK-36                          | -                             | -                          | DRK 36" deep |
| CBS-ERK-20                          | CBS-ERK-20R                   | -                          | ERK 20" deep |
| CBS-ERK-25                          | CBS-ERK-25R                   | -                          | ERK 25" deep |

Fine floor casters constructed from Dynatread TPR to protect fine flooring!



## Inner Platform Base



amplifier installation without inner platform base



amplifier installation is simplified with inner platform base

## Seismic Floor Anchor Brackets

When properly installed, seismic floor anchor brackets bring any Seismic Certified DRK, WRK, MRK, VMRK, VRK, ERK, SC, SCQ, SCRK and SCQRK Series enclosure to Zone 4 and Seismic Use Group III Upper Floor Essential Equipment rating and have an Ip rating of 1.5. Includes four brackets.

| Part # | Fits                        |
|--------|-----------------------------|
| WRK-Z4 | WRK Series                  |
| MRK-Z4 | DRK, MRK, VMRK Series       |
| VRK-Z4 | VRK Series                  |
| ERK-Z4 | ERK Series                  |
| SC-Z4  | SC, SCQ, SCRK, SCQRK Series |

Seismic Certified riser bases available, see pg. 27

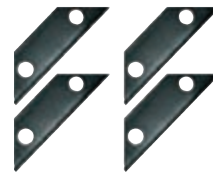

SEISMIC BRACKET

## Rack Base Templates

Use these handy bottom templates for pre-installation of floor anchor bolts prior to the arrival of the racks. Conveniently keyed to interlock, use two and "leapfrog" them to layout entire bays of racks.

| Part #      | Description                   |
|-------------|-------------------------------|
| WRK-TEMP-27 | bottom template for WRK-XX-27 |
| WRK-TEMP-32 | bottom template for WRK-XX-32 |
| MRK-TEMP-26 | bottom template for MRK-XX-26 |
| MRK-TEMP-31 | bottom template for MRK-XX-31 |
| MRK-TEMP-36 | bottom template for MRK-XX-36 |

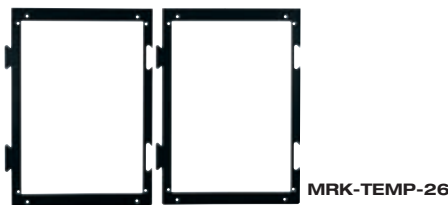

MRK-TEMP-26

## Crating Service

Reusable economical transport protection for any steel rack enclosure. Removable front and rear panels allow loading & testing of racks while still in the crate. Truck transit tested; ship racks & equipment around the corner or around the country.

**Part #** NOTE: When ordering CRATE, please specify the rack it is for as well as any options to be installed such as caster bases, side panels, etc. that increase the size of the crate needed. CRATE is a custom item and cannot be canceled once ordered.

## Rail Bracket Adaptors

Adaptors allow for the vertical mounting of rack panels or electronics between rackrail brackets.

| Part #     | Description | Fits             |
|------------|-------------|------------------|
| RBA-W44-1  | 1 space     | 44 space WRK     |
| RBA-W44-2  | 2 space     | 44 space WRK     |
| RBA-W44-3  | 3 space     | 44 space WRK     |
| RBA-MV44-1 | 1 space     | 44 space MRK/VRK |
| RBA-MV44-2 | 2 space     | 44 space MRK/VRK |
| RBA-MV44-3 | 3 space     | 44 space MRK/VRK |

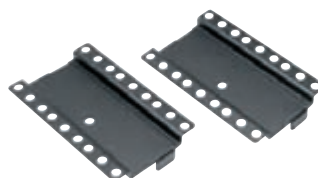

RBA Series rail bracket adaptor shown with patch panel



CRATE



# Universal Enclosure Options

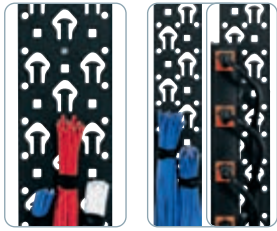

**LACE-44-OWP** **LACE-44-OP**  
shown w/cable & power

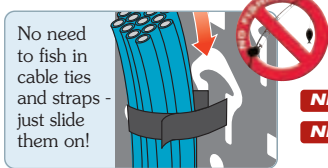

**LACE-44-1P** **LACE-44-1SP**

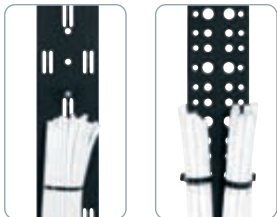

**LACE-44LP** **LACE-P**



**BB-44-1** **BB-40**

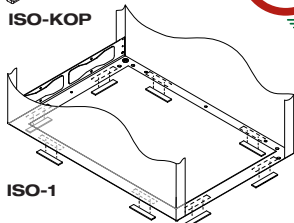
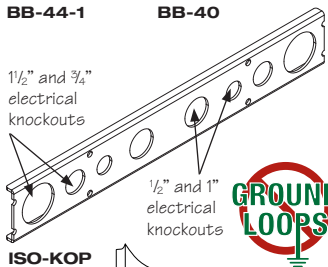

## Vertical Lacer Strips

Perforated steel lacer strips mount vertically to rackrail brackets and provide many locations for securing cable bundles. Lacer strips can be cut down easily to smaller sizes. LACE-OWP and LACE-OP strips with tie posts for sliding on pre-wrapped cable bundles using 3/4" hook-and-loop straps or cable ties. Some lacer strips also accept cage nuts or mounting of select power strips for increased versatility. All strips sold in packs of 6.

| Part #                  | Description                                       | Qty | Compatible Cable Mgmt Options <b>NEW</b> |          |      |           |                     |
|-------------------------|---|-----|--|----------|------|-----------|---------------------|
|                         |   |     | Cable Ties                               | TSW-15   | TW12 | Cage Nuts | Anti-Slip Cable Pad |
| LACE-44-OWP*            | 4 3/4" width, 44 space w/ tie posts               | 6   | ✓  | ✓        | ✓    | ✓         | ✓                   |
| LACE-40-OWP*            | 4 3/4" width, 40 space w/ tie posts               | 6   | ✓  | ✓        | ✓    | ✓         | ✓                   |
| LACE-37-OWP*            | 4 3/4" width, 37 space w/ tie posts               | 6   | ✓  | ✓        | ✓    | ✓         | ✓                   |
| <b>NEW</b> LACE-23-OWP* | 4 3/4" width, 23 space w/ tie posts               | 6   | ✓  | ✓        | ✓    | ✓         | ✓                   |
| <b>NEW</b> LACE-13-OWP* | 4 3/4" width, 13 space w/ tie posts               | 6   | ✓  | ✓        | ✓    | ✓         | ✓                   |
| LACE-44-OP*             | 3 3/4" width, 44 space w/ tie posts               | 6   | ✓  | ✓        | ✓    | ✓         | -                   |
| LACE-40-OP*             | 3 3/4" width, 40 space w/ tie posts               | 6   | ✓  | ✓        | ✓    | ✓         | -                   |
| LACE-37-OP*             | 3 3/4" width, 37 space w/ tie posts               | 6   | ✓  | ✓        | ✓    | ✓         | -                   |
| <b>NEW</b> LACE-23-OP*  | 3 3/4" width, 23 space w/ tie posts               | 6   | ✓  | ✓        | ✓    | ✓         | -                   |
| <b>NEW</b> LACE-13-OP*  | 3 3/4" width, 13 space w/ tie posts               | 6   | ✓  | ✓        | ✓    | ✓         | -                   |
| LACE-44LP               | 3 1/2" width, 44 space w/ raised lances           | 6   | ✓  | -        | ✓    | -         | -                   |
| LACE-37LP               | 3 1/2" width, 37 space w/ raised lances           | 6   | ✓  | -        | ✓    | -         | -                   |
| LACE-P*                 | 2" width, 45 space, 1/8" thick w/ round holes     | 6   | ✓  | ✓        | -    | -         | -                   |
| LACE-37P*               | 2" width, 37 space, 1/8" thick w/ round holes     | 6   | ✓  | ✓        | -    | -         | -                   |
| <b>NEW</b> LACE-13P*    | 2" width, 13 space, 1/8" thick w/ round holes     | 6   | ✓  | ✓        | -    | -         | -                   |
| LACE-44-1SP             | 1" width, 44 space w/10 pre-installed tie saddles | 6   | ✓  | included | ✓    | -         | -                   |
| LACE-37-1SP             | 1" width, 37 space w/10 pre-installed tie saddles | 6   | ✓  | included | ✓    | -         | -                   |
| LACE-44-1P*             | 1" width, 44 space tapped for tie saddles         | 6   | ✓  | ✓        | -    | -         | -                   |
| LACE-37-1P*             | 1" width, 37 space tapped for tie saddles         | 6   | ✓  | ✓        | -    | -         | -                   |

\*NOTE: Also accepts mounting of PD Slim & PDT Series vertical power

## Anti-Slip Cable Pad **NEW**

Innovative high friction material mounts to OWP Series Lace and reduces weight of cables by 40%!

| Part #    | Qty |
|-----------|-----|
| ASP-OWP   | 4   |
| ASP-OWP-6 | 24  |



## Copper Buss Bars

Copper buss bars are 1/8" thick and threaded 10-32. Various heights and widths available. Supplied mounting hardware includes nylon isolation washers, bolts and nuts.

| Part #  | Racking Height | Width | Qty   | Part # | Racking Height | Width | Qty   |
|---------|----------------|-------|-------|--------|----------------|-------|-------|
| BB-44-1 | 77" (44 space) | 1"    | 1 bar | BB-12  | 21" (12 space) | 2"    | 1 bar |
| BB-40   | 70" (40 space) | 2"    | 1 bar |        |                |       |       |

## Electrical Isolation Knockout Panel

The Electrical Isolation Knockout Panel is ideal for installations that require electrical conduit to be isolated from the enclosure. Replaces the standard rear electrical knockout plates. Constructed from 1/8" thick non-conductive polycarbonate. Hardware included.

| Part #  | Fits   |
|---------|--|
| ISO-KOP | ISO-KOP top or bottom of MRK, WRK, DRK, ERK and SCRK Series enclosures; bottom of 60° SC and SCQ Series consoles |

## Rack Ground Isolation Kit

Isolate the rack from conductive flooring materials when installing in an isolated (technical) ground environment. The Rack Ground Isolation Kit consists of eight 4" long strips of 1/8" thick non-conductive polycarbonate which are attached to the rack base and prevent floor contact.

| Part # |
|--------|
| ISO-1  |

## Leveling Feet

Adjustable leveling feet fit all Middle Atlantic Products floor standing steel racks and enclosures (excludes VRK Series). Isolation Leveling Feet feature protective rubber cover to isolate racks from the floor. Flat-blade and hex drive allows for adjustment. Also used with caster bases for MRK, WRK and DRK Series racks. Set of four.  
NOTE: Raises enclosure from 1/8" to 1" off floor

| Part # | Description             |
|--------|-------------------------|
| LF     | leveling feet           |
| LF-ISO | isolation leveling feet |

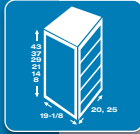

# Slim 5 Series Equipment Rack Enclosure

## Versatile Rack Frame System Satisfies Many Design Requirements

Specify a Slim 5 when multiple racks need to be joined or when open sides are desirable. Ships ready-to-assemble to reduce shipping costs.

### Structural Features

- ✓ Available in 20" and 26" useable depths
- ✓ Weight Capacity:
  - Static load capacity, 1,000 lbs.
  - UL Listed load capacity, 400 lbs.
- ✓ Wide range of cabinet options makes rack adaptable to a multitude of different installation environments
- ✓ Optional removable steel side panels provide security while attractive thermolaminate top and side panel options provide aesthetic appeal for home and studio installations
- ✓ Heavy-duty 14-gauge steel top and bottom contribute to unsurpassed rigidity of rack design
- ✓ Standard front and rear fixed 11-gauge, 10-32 threaded rackrail with marked rackspace increments to speed equipment mounting
- ✓ Optional casters can be bolted directly to bottom of rack or concealed in skirted base
- ✓ Unique mechanically interlocking corner joint is central to each unit's exceptional strength and eases assembly
- ✓ Bolt-together design allows for flat shipment via UPS
- ✓ 1/2" and 3/4" top and bottom electrical knockouts in rear of rack for cable pass-through
- ✓ **NEW** top accepts two fans
- ✓ UL Listed in the US and Canada

TIA/EIA COMPLIANT cUL US LISTED

A&E SPEC. # 96-037



26" deep Slim 5 shown with granite gray steel side panels



**NEW** shown with dark cherry side and top panels and plexiglass front door



### Thermolaminate Side and Top Colors Available:



### Steel Side Panel Colors Available:

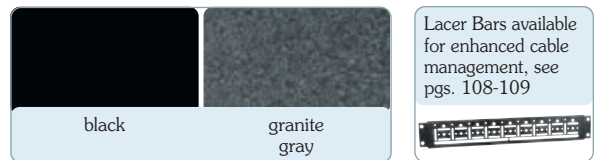

### Top Fan Kit **NEW**

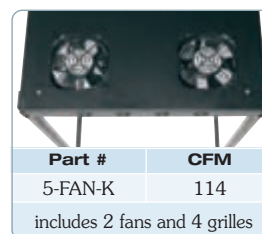

### Zero Space Rackshelf

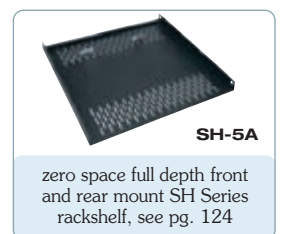







| 20" Useable Depth Part # | 26" Useable Depth Part # | Racking Height     | Overall Height | Recommended Power |
|--------------------------|--------------------------|--------------------|----------------|-------------------|
| 5-43                     | 5-43-26                  | 75 1/4" (43 space) | 79"            | N P T ■           |
| 5-37                     | 5-37-26                  | 64 3/4" (37 space) | 68 1/2"        | G J N ■           |
| 5-29                     | 5-29-26                  | 50 3/4" (29 space) | 54 1/2"        | E G J ■           |
| 5-21                     | 5-21-26                  | 36 3/4" (21 space) | 40 1/2"        | E G ■             |
| 5-14                     | 5-14-26                  | 24 1/2" (14 space) | 28 3/4"        | C ■               |
| 5-8                      | 5-8-26                   | 14" (8 space)      | 17 3/4"        | C ●               |

See pgs. 64-79 for complete list of power products. ■ Requires PB-5A to mount power strip, see pg. 69. ● Requires PB-XS to mount power strip, see pg. 69.



## Slim 5 Series Equipment Rack Enclosure Options

**Casters** casters add 3 7/8" to overall cabinet height

|   |   |   |   |  |  |
|---|---|---|---|--|--|
|  |  |  |  |    |   |
| <b>5W</b><br>set of 4<br>commercial<br>grade casters                              | <b>5WR</b><br>set of 4<br>fine floor<br>casters                                   | <b>5WL</b><br>set of 4<br>commercial grade<br>locking casters                     | <b>5WLR</b><br>set of 4<br>locking fine<br>floor casters                          | <b>CBS-5</b> skirted base with 4<br>commercial grade non-locking<br>casters, fits 20" depth models;<br><b>CBS-5-26</b> fits 26" depth models | <b>CBS-5R</b> skirted base<br>with 4 fine floor non-locking<br>casters, fits 20" depth models;<br><b>CBS-5-26R</b> fits 26" depth models |

### Door Options, Side Panels, Rear Access Pans, Rear Rackrail

| Rack Part # | Solid Front Door | Plexi Front Door | Steel Side Panels, Pair | Top and Side Panels** | Rear Access Panel | Adjustable "Split" Rear Rackrail | Cable Chase 3" wide* |
|-------------|------------------|------------------|-------------------------|-----------------------|-------------------|----------------------------------|----------------------|
| 5-43        | DO-5-43          | DOP-5-43         | SP-5-43                 | TSP-5-43xx            | RAP43             | 5AR43                            | 5CC43                |
| 5-37        | DO-5-37          | DOP-5-37         | SP-5-37                 | TSP-5-37xx            | RAP37             | 5AR37                            | 5CC37                |
| 5-29        | DO-5-29          | DOP-5-29         | SP-5-29                 | TSP-5-29xx            | RAP29             | 5AR29                            | 5CC29                |
| 5-21        | DO-5-21          | DOP-5-21         | SP-5-21                 | TSP-5-21xx            | RAP21             | 5AR21                            | 5CC21                |
| 5-14        | DO-5-14          | DOP-5-14         | SP-5-14                 | TSP-5-14xx            | RAP14             | 5AR14                            | 5CC14                |
| 5-8         | DO-5-8           | DOP-5-8          | SP-5-8                  | -                     | RAP8              | 5AR8                             | 5CC8                 |
| 5-43-26     | DO-5-43          | DOP-5-43         | SP-5-43-26•             | TSP-5-43-26xx         | RAP43             | 5AR43-26                         | 5CC43-26             |
| 5-37-26     | DO-5-37          | DOP-5-37         | SP-5-37-26•             | TSP-5-37-26xx         | RAP37             | 5AR37-26                         | 5CC37-26             |
| 5-29-26     | DO-5-29          | DOP-5-29         | SP-5-29-26•             | TSP-5-29-26xx         | RAP29             | 5AR29-26                         | 5CC29-26             |
| 5-21-26     | DO-5-21          | DOP-5-21         | SP-5-21-26•             | TSP-5-21-26xx         | RAP21             | 5AR21-26                         | 5CC21-26             |
| 5-14-26     | DO-5-14          | DOP-5-14         | SP-5-14-26•             | TSP-5-14-26xx         | RAP14             | 5AR14-26                         | 5CC14-26             |
| 5-8-26      | DO-5-8           | DOP-5-8          | SP-5-8-26•              | -                     | RAP8              | 5AR8-26                          | 5CC8-26              |

•Suffix part number with GY for granite gray finish. \*Custom width cable chases available, please call for details.

\*\*Replace 'xx' with DC=Dark Cherry, MP=Maple, LW=Light Walnut or PS=Pepperstone top (slate sides)

### Power Distribution & Lighting

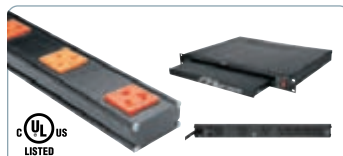

vertical and rackmount power and lighting available please see pgs. 64-79

### Trim Panels

| Part #    | Finish                      |
|-----------|-----------------------------|
| 5-CAVTRIM | silver brushed and anodized |
| 5-BAVTRIM | black brushed and anodized  |



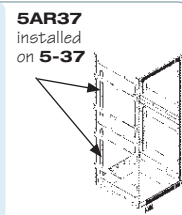

top and bottom trim panels available to match the finish of the products mounted within the enclosure, includes 2 pieces

### Adjustable "Split" Rear Rackrail

- ✓ Facilitates rear hanging of equipment
- ✓ Permits panels to be "mid-mounted"
- ✓ All brackets, rails and hardware included
- ✓ Cable chase kit required when using this option with ganged enclosures
- ✓ Works with steel side panels only; will not accommodate wood side panels



### Installation and Ordering Notes

|  |  |   |  |
|--|--|---|--|
|   |   |    |   |
| Top and side panels are constructed from thermolaminated MDF. Will not work when using split rear rackrail options.<br><br>WUSS and SH Series shelves need to be installed prior to installation of wood side panels, which conveniently lift off. | Removable Steel Side Panels are vented top and bottom with recessed lift handles and internal locking clips.<br><br>Made from 18-gauge steel and finished in a durable black textured powder coat, each side panel adds 3/8" per side to overall enclosure width. Side panels for 26" deep Slim 5 also available with granite gray finish. | Doors are capable of being installed with a right or left swing and are equipped with a cam keylock and attractive flush handle.<br><br>Requires the use of a cable chase when used in multi-bay installations. Doors provide 1 1/2" clearance. | Rear access pans feature a unique no-hinge "tip-out lift-off" design with a laser knockout for cable pass-through on the bottom.<br><br>Securing keylock included. |

### Dimensions

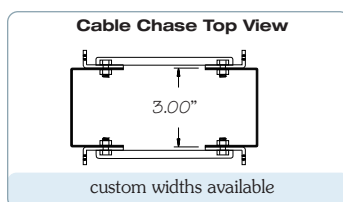



### Runner Kit **NEW**

low-friction runner allows the Slim 5 to easily slide in and out of credenzas and lecterns

| Model # | Fits            |
|---------|-----------------|
| 5-RS20  | 20" deep models |
| 5-RS26  | 26" deep models |

### Trim Strips

add the finishing touch to any installation, see pg. 120

|   |   |
|---|---|
|  |  |
| without trim strip installed  | with trim strip installed   |



# Laminate Racks

## Laminate Racks

TIA/EIA COMPLIANT  
A&E SPEC. # 96-032

These elegant, cost effective 19" equipment racks are modular, studio-grade components well suited for any permanent installation. Featuring a **NEW** maple, oak or black wood grain finish, these versatile equipment racks are offered with a variety of options for superior equipment mounting, mobility & aesthetics. Four depths are now available to accommodate larger components and all racks are easily assembled using the included hardware. 16" and 18" depth models include one set of rackrail, **NEW** 22" and 28" depth models include front and rear rackrail.

| Black Wood Grain Part# | Oak Laminate Part # | Maple Laminate Part # | Racking Height   | Depth | Overall Height | Weight Capacity | Smoke Tempered Glass Front Door | Add'l 10-32 Threaded Rackrail | Rear Access Panel, Black Finish* | Rear Access Panel, Maple Finish | Recommended Power* | ups |
|------------------------|---------------------|-----------------------|--|-------|----------------|-----------------|---------------------------------|-------------------------------|----------------------------------|---------------------------------|--------------------|-----|
| RK2                    |                     |                       | 3½" (2 space)  | 16"   | 5"             | 200 lbs.        |                                 | RK-RR2                        |                                  |                                 |                    | ✓   |
| RK4                    |                     |                       | 7" (4 space)   | 16"   | 8½"            | 200 lbs.        |                                 | RK-RR4                        |                                  |                                 |                    | ✓   |
| RK6                    |                     |                       | 10½" (6 space)   | 16"   | 12"            | 200 lbs.        |                                 | RK-RR6                        |                                  |                                 |                    | ✓   |
| RK8                    |                     |                       | 14" (8 space)  | 16"   | 15½"           | 200 lbs.        |                                 | RK-RR8                        |                                  |                                 |                    | ✓   |
| RK10                   |                     |                       | 17½" (10 space)  | 16"   | 19"            | 200 lbs.        |                                 | RK-RR10                       |                                  |                                 |                    | ✓   |
| RK12                   |                     |                       | 21" (12 space)   | 16"   | 22½"           | 200 lbs.        |                                 | RK-RR12                       |                                  |                                 | C                  | ✓   |
| RK14                   |                     |                       | 24½" (14 space)  | 16"   | 26"            | 200 lbs.        |                                 | RK-RR14                       |                                  |                                 | C                  | ✓   |
| RK16                   |                     |                       | 28" (16 space)   | 16"   | 29½"           | 200 lbs.        |                                 | RK-RR16                       |                                  |                                 | C                  | ✓   |
| RK20                   |                     |                       | 35" (20 space)   | 16"   | 36½"           | 200 lbs.        |                                 | RK-RR20                       |                                  |                                 | C E                | ✓   |
| BRK6                   |                     |                       | 10½" (6 space)   | 18"   | 12"            | 200 lbs.        | RK-GD6                          | RK-RR6                        |                                  |                                 |                    | ✓   |
| BRK8                   | OBRK8               | MBRK8                 | 14" (8 space)  | 18"   | 15½"           | 200 lbs.        | RK-GD8                          | RK-RR8                        |                                  |                                 |                    | ✓   |
| BRK10                  |                     |                       | 17½" (10 space)  | 18"   | 19"            | 200 lbs.        | RK-GD10                         | RK-RR10                       |                                  |                                 |                    | ✓   |
| BRK12                  | OBRK12              | MBRK12                | 21" (12 space)   | 18"   | 22½"           | 200 lbs.        | RK-GD12                         | RK-RR12                       |                                  |                                 | C                  | ✓   |
| BRK14                  |                     |                       | 24½" (14 space)  | 18"   | 26"            | 200 lbs.        | RK-GD-14                        | RK-RR14                       |                                  |                                 | C                  | ✓   |
| BRK16                  | OBRK16              | MBRK16                | 28" (16 space)   | 18"   | 29½"           | 200 lbs.        | RK-GD-16                        | RK-RR16                       |                                  |                                 | C                  | ✓   |
| BRK20                  | OBRK20              | MBRK20                | 35" (20 space)   | 18"   | 36½"           | 200 lbs.        | RK-GD-20                        | RK-RR20                       |                                  |                                 | C E                | ✓   |
| <b>NEW</b> BRK8-22**   |                     | MBRK8-22**            | 14" (8 space)  | 22"   | 15½"           | 200 lbs.        | RK-GD8                          | RK-RR8                        | RK-RAP8                          | RK-RAP8-MP                      |                    | ✓   |
| <b>NEW</b> BRK12-22**  |                     | MBRK12-22**           | 21" (12 space)   | 22"   | 22½"           | 200 lbs.        | RK-GD12                         | RK-RR12                       | RK-RAP12                         | RK-RAP12-MP                     | C                  | ✓   |
| <b>NEW</b> BRK16-22**  |                     | MBRK16-22**           | 28" (16 space)   | 22"   | 29½"           | 200 lbs.        | RK-GD-16                        | RK-RR16                       | RK-RAP16                         | RK-RAP16-MP                     | C                  | ✓   |
| <b>NEW</b> BRK20-22**  |                     | MBRK20-22**           | 35" (20 space)   | 22"   | 36½"           | 250 lbs.        | RK-GD-20                        | RK-RR20                       | RK-RAP20                         | RK-RAP20-MP                     | C E                | ✓   |
| <b>NEW</b> BRK28-22**  |                     | MBRK28-22**           | 49" (28 space)   | 22"   | 50½"           | 250 lbs.        | RK-GD-28                        |                               | RK-RAP28                         | RK-RAP28-MP                     | C E G J            | ✓   |
| <b>NEW</b> BRK12-28**  |                     | MBRK12-28**           | 21" (12 space)   | 28"   | 22½"           | 200 lbs.        | RK-GD12                         | RK-RR12                       | RK-RAP12                         | RK-RAP12-MP                     | C                  | ✓   |
| <b>NEW</b> BRK16-28**  |                     | MBRK16-28**           | 28" (16 space)   | 28"   | 29½"           | 200 lbs.        | RK-GD-16                        | RK-RR16                       | RK-RAP16                         | RK-RAP16-MP                     | C                  | ✓   |
| <b>NEW</b> BRK20-28**  |                     | MBRK20-28**           | 35" (20 space)   | 28"   | 36½"           | 250 lbs.        | RK-GD-20                        | RK-RR20                       | RK-RAP20                         | RK-RAP20-MP                     | C E                | ✓   |
| <b>NEW</b> BRK28-28**  |                     | MBRK28-28**           | 49" (28 space)   | 28"   | 50½"           | 250 lbs.        | RK-GD-28                        |                               | RK-RAP28                         | RK-RAP28-MP                     | C E G J            | ✓   |
| RKW                    |                     |                       | Wheel kit - 2 locking, 2 non-locking (adds 2 3/4" to height), 150 lb. Weight capacity        |       |                |                 |                                 |                               |                                  |                                 |                    |     |
| <b>NEW</b> RKW-HD      |                     |                       | Heavy Duty Wheel kit - 2 locking, 2 non-locking (adds 3" to height), 250 lb. Weight capacity |       |                |                 |                                 |                               |                                  |                                 |                    |     |
| <b>NEW</b> DCFANKIT-4  |                     |                       | 100 CFM DC fan kit, mounts in top of the Rear Access Panel                                   |       |                |                 |                                 |                               |                                  |                                 |                    |     |

• To install power strips, quick-clips must be screwed to sides, or PB-5A used on optional rear rackrail. See pgs. 64-79 for complete list of power products. \*Includes top vent panel, and bottom cable pass-through. \*\* Includes front & rear rackrail.



# Oak Laminate Racks/Desktop Racks

## Slim 2 Series Sloped Desktop Racks - Available in Two Styles



2-10 shown with sides removed

2-10 shown with sides installed

TIA/EIA COMPLIANT

A&E SPEC. # 96-036

The 2-10 rack ships fully assembled and incorporates a sturdy black steel open frame and removable black laminate side panels. Featuring a sloping rack face for easy equipment viewing, this frame can be easily joined, with the open sides and bottom allowing for quick wire passage. Front and rear 11-gauge, 10-32 threaded rackrail is standard.

| Part # | Racking Height  | Top Depth | Bottom Depth | Overall Height |
|--------|-----------------|-----------|--------------|----------------|
| 2-10   | 17½" (10 space) | 14⅞"      | 18"          | 19⅞"           |

Ready-To-Assemble Black Laminate - Ships Flat! SLIM-2M racks assemble quickly and easily with provided hardware. Constructed with ¾" thick furniture-grade MDF board, these black laminate racks are available in 6 or 10 space sizes and feature a sloping rack face for easy equipment viewing. Front and rear 11-gauge, 10-32 threaded rackrail is standard.

| Part # | Racking Height  | Top Depth | Bottom Depth | Overall Height |
|--------|-----------------|-----------|--------------|----------------|
| 2-6M   | 10½" (6 space)  | 15⅞"      | 17⅞"         | 12¾"           |
| 2-10M  | 17½" (10 space) | 14¾"      | 17⅞"         | 19⅞"           |



2-10M

7" deep at the top



black wood grain finish



TIA/EIA COMPLIANT

A&E SPEC. # 96-032

## SRK Series Sloped Rolling Equipment Rack

Standing 54⅝" high and measuring 16" deep, the SRK rolling rack houses 16 vertical spaces on the bottom and 12 spaces on its 25° sloped top. Built using ⅝" furniture-grade MDF board finished with an enhanced black wood grain finish, each unit includes pre-installed 11-gauge 10-32 threaded front rackrail and casters. Assembly is easy with supplied hardware. For rear rackrail please see pg. 133.

| Part # | Weight Capacity | Power Strip |
|--------|-----------------|-------------|
| SRK    | 200 lbs.        | C E         |



•To install power strips, quick-clips must be screwed to sides, or PB-5A used on optional rear rackrail, see pg. 69. See pgs. 64-79 for complete list of power products.

## OSR Series Sloped Oak Laminate Rolling Equipment Racks

OSR Series racks feature a gently sloped 5° rack face to facilitate equipment viewing. Utilizing the same attractive ¾" oak laminate construction found on the OBRK series, each OSR Series rack additionally features casters to enhance mobility.

Factory-installed 11-gauge, 10-32 threaded front rackrail is standard. For rear rackrail please see pg. 133.

| Part # | Racking Height | Depth at Top | Depth at Bottom | Overall Height | Weight Capacity | Recommended Power |
|--------|----------------|--------------|-----------------|----------------|-----------------|-------------------|
| OSR16  | 28" (16 space) | 19½"         | 23"             | 36½"           | 200 lbs.        | C                 |
| OSR24  | 42" (24 space) | 19½"         | 23"             | 50½"           | 200 lbs.        | C E G J           |

See pgs. 64-79 for complete list of power products.

•To install power strips, quick-clips must be screwed to sides, or PB-5A used on optional rear rackrail see pg. 69.



rear rackrail available, please see pg. 133

OSR24

features locking commercial grade casters

20 5/8"

TIA/EIA COMPLIANT

TIA/EIA COMPLIANT

## Desktop Rail Racks

Quickly and inexpensively organize desktop processing and test equipment with our DR Series desktop rail racks. Offered in 8 and 12 space sizes, both models extend upward at a gentle slope. Overall width is 19⅞", depth is 11½".

| Part # | Racking Height | Overall Height | Weight Capacity |
|--------|----------------|----------------|-----------------|
| DR-8   | 14" (8 space)  | 15¾"           | 75 lbs.         |
| DR-12  | 21" (12 space) | 22¾"           | 75 lbs.         |



Mounts without rack screws! No tools required.

## Quick-Position™ Shelves

Convenient pin-mount shelves speed installation and allow for simplified mounting of rackmount and non-rackmount components in BRK/OBRK Series racks. Engineered ventilation slots maximize airflow while cable management slots simplify wiring. Mounts in 2½" increments and accepts C power strips. Constructed from 16-gauge steel, includes mounting hardware and is finished in a durable black powder coat.

| Part #    | Description           | Fits     | Qty |
|-----------|-----------------------|----------|-----|
| SH-BRK    | Quick-Position™ Shelf | BRK/OBRK | 1   |
| SH-BRK-3P | Quick-Position™ Shelf | BRK/OBRK | 3   |

SH-BRK attractive alternative to bulkier rail mount rack shelves

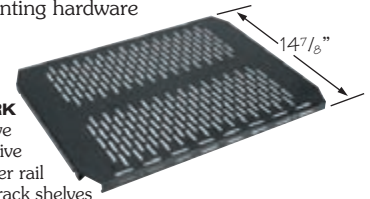

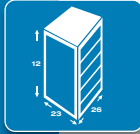

# ISRK Series Under Desk/Rolling Presentation Rack

UL LISTED  
TIA/EIA COMPLIANT

A&E SPEC.  
# 96-01011

ISRK Series sloped rack features scuff resistant Glide-Away™ front door. For use in all applications where an under desk or mobile presentation rack is required, including control desk, mixing, testing, and recording desks.

### Structural Features

- ✓ Rolls under all standard height desks
- ✓ 15 degree slope provides an ergonomic viewing angle when used under-desk
- ✓ Scuff resistant Glide-Away™ front door easily hides away, and requires minimal clearance in cramped environments
- ✓ Features 12 useable rackspaces, front and rear, to ensure all useable space is accessible
- ✓ Knockouts on face of rack accept RPS Series remote power switch and other low-voltage Decora® style switches or devices
- ✓ Secure, locking front door, full height locking rear door
- ✓ Easily removable front and rear door
- ✓ Robust 200 lb. weight capacity accommodates virtually all equipment mounting needs
- ✓ Durable, aesthetically pleasing granite gray finish
- ✓ Up to 21¾" useable depth

### Thermal Management

- ✓ Designed for effective Passive thermal management

### Cable Management

- ✓ Abundant internal cable lacing points facilitate cable management
- ✓ Removable electrical knockout panels for ease of cable entry/exit

### Code Compliancy

- ✓ UL Listed in the US and Canada

| Part #       | Description                                      |
|--------------|--|
| ISRK-12GY    | 12 rackspace under desk/mobile presentation rack |
| WS1-ISRK-21G | ISRK work surface, graphite finish               |
| LD-AM1X1*    | single LCD mount, articulating, black finish     |

\*25 lb. weight capacity

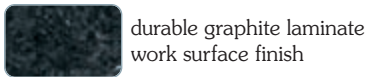
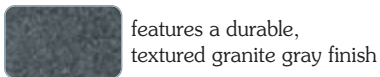

Also available in black, please call for details.

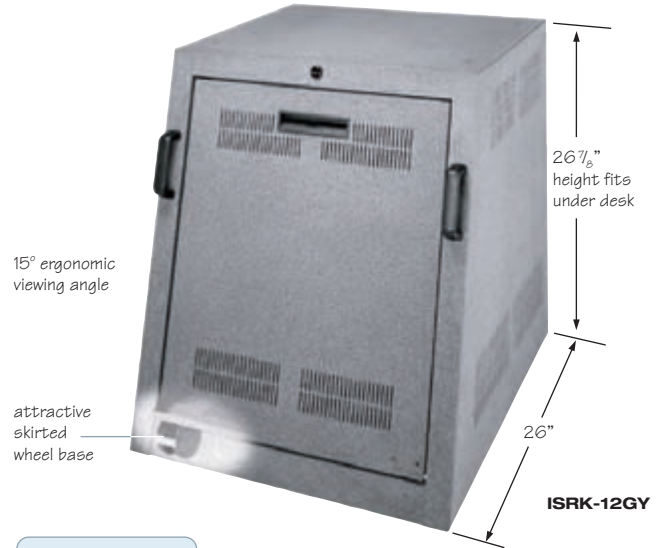
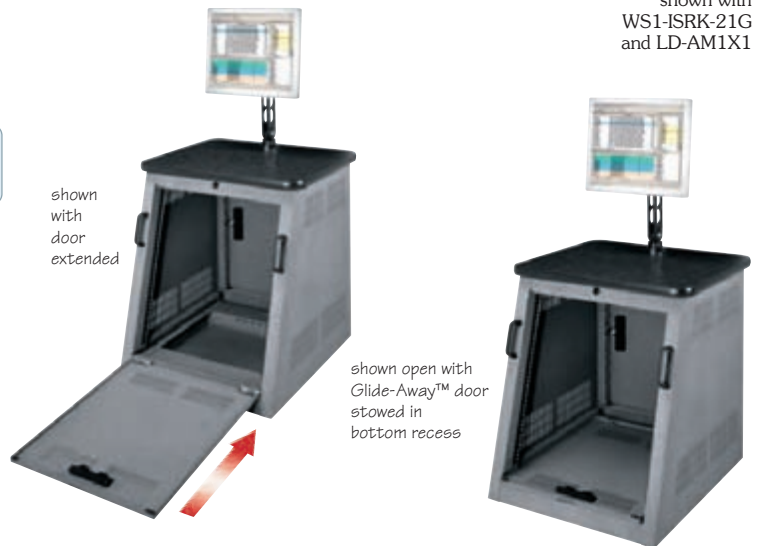

Glide-Away™ scuff resistant front door hides away easily



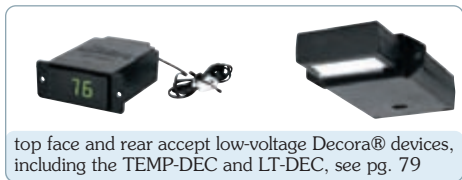

top face and rear accept low-voltage Decora® devices, including the TEMP-DEC and LT-DEC, see pg. 79

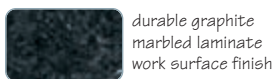

durable graphite marbled laminate work surface finish

includes graphite laminate top and plexi front door

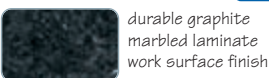

## PTRK Series Portable Racks

Specify a PTRK when a rugged, portable rack is essential. Smooth rolling 4" casters, advanced cable management and secure doors make this rack ideal for serving a variety of applications.

- ✓ Ruggedly welded 16-gauge steel construction and 1/8" thick laser cut corner braces provide a robust 500 lb. weight capacity
- ✓ Heavy-duty commercial grade locking casters and spring-loaded recessed side handles facilitate rack transport
- ✓ Keylocked front and rear doors standard for advanced security
- ✓ Finished in a durable black textured powder coat
- ✓ Slots incorporated into bottom of rack for cable strain relief and mounting of boxes
- ✓ Standard front adjustable 11-gauge, 10-32 threaded rackrail with smooth laser cut cable openings and numbered rackspace increments speed equipment mounting
- ✓ **ENHANCED** stud in base of rack facilitates proper grounding and bonding of electronic equipment, as per NEBS and NEC standards
- ✓ Also available with graphite-marbled laminate top and plexi front door

TIA/EIA COMPLIANT

A&E SPEC. # 96-154

| Part #         | Racking Height                              | Overall Height                                       | Useable Depth                    | Recommended Power |
|----------------|---|--|----------------------------------|-------------------|
| PTRK-14        | 24 <sup>1</sup> / <sub>2</sub> " (14 space) | 33 <sup>3</sup> / <sub>4</sub> " (including casters) | 21 <sup>1</sup> / <sub>2</sub> " | <b>C</b>          |
| PTRK-14MDK**   | 24 <sup>1</sup> / <sub>2</sub> " (14 space) | 34 <sup>3</sup> / <sub>4</sub> " (including casters) | 21 <sup>1</sup> / <sub>2</sub> " | <b>C</b>          |
| PTRK-21        | 36 <sup>3</sup> / <sub>4</sub> " (21 space) | 46" (including casters)                              | 21 <sup>1</sup> / <sub>2</sub> " | <b>E G</b>        |
| PTRK-21MDK**   | 36 <sup>3</sup> / <sub>4</sub> " (21 space) | 47" (including casters)                              | 21 <sup>1</sup> / <sub>2</sub> " | <b>E G</b>        |
| PTRK-1426      | 24 <sup>1</sup> / <sub>2</sub> " (14 space) | 33 <sup>3</sup> / <sub>4</sub> " (including casters) | 24 <sup>1</sup> / <sub>2</sub> " | <b>C</b>          |
| PTRK-1426MDK** | 24 <sup>1</sup> / <sub>2</sub> " (14 space) | 34 <sup>3</sup> / <sub>4</sub> " (including casters) | 24 <sup>1</sup> / <sub>2</sub> " | <b>C</b>          |
| PTRK-2126      | 36 <sup>3</sup> / <sub>4</sub> " (21 space) | 46" (including casters)                              | 24 <sup>1</sup> / <sub>2</sub> " | <b>E G</b>        |
| PTRK-2126MDK** | 36 <sup>3</sup> / <sub>4</sub> " (21 space) | 47" (including casters)                              | 24 <sup>1</sup> / <sub>2</sub> " | <b>E G</b>        |
| PTRK-2726      | 47 <sup>1</sup> / <sub>4</sub> " (27 space) | 56 <sup>1</sup> / <sub>2</sub> " (including casters) | 24 <sup>1</sup> / <sub>2</sub> " | <b>E G</b>        |
| PTRK-2726MDK** | 47 <sup>1</sup> / <sub>4</sub> " (27 space) | 57 <sup>1</sup> / <sub>2</sub> " (including casters) | 24 <sup>1</sup> / <sub>2</sub> " | <b>E G</b>        |

\*\*Includes graphite laminate top and plexi front door. See pgs. 64-79 for complete list of power products.

### PTRK Series Accessories

| Part #    | Fits            | Description                                  |
|-----------|-----------------|--|
| PTRK-RR14 | 14 space models | additional 10-32 threaded rear rackrail      |
| PTRK-RR21 | 21 space models | additional 10-32 threaded rear rackrail      |
| PTRK-RR27 | 27 space models | additional 10-32 threaded rear rackrail      |
| LD-AM1X1* | MDK models      | single LCD mount, articulating, black finish |

\*25 lb. weight capacity



Micro Fiber Cleaning Cloths keep anodized finishes & plexi doors clean, see pg. 133

## WRK-24MDK Presentation Enclosure System

WRK-24MDK studio enclosure system combines furniture elegance with a robust rolling steel enclosure in a deep video rack. Incorporating an attractive graphite-marbled laminate top that can accommodate large video monitors, the WRK-24MDK comes with a skirted wheel-base, latching front plexi door, latching vented rear door, and front and rear rackrail.

| Part #    | Description   |
|-----------|---|
| WRK-24MDK | 42" (24 space) x 32" deep presentation enclosure system |
| LD-AM1X1* | single LCD mount, articulating, black finish            |

\*25 lb. weight capacity

TIA/EIA COMPLIANT

A&E SPEC. # 96-0255A

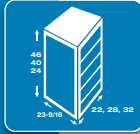

# SR Series Pivoting Rack

## Unique Tall Wall Rack Pivots on Floor Base for Easy Equipment Access

Specify an SR when access to rear equipment connections is essential. This pivoting rack is uniquely designed to mount to the wall while the base provides additional support and cable management facilities.

### Structural Features

- ✓ Zero Clearance Latch option allows side-by-side or corner mounting
- ✓ Center section rear channel accommodates slim power to save space
- ✓ Pivots 90° on floor base for access to rear equipment connections
- ✓ 500 lb. weight capacity
- ✓ 8¾" bottom cable entry platform bears the weight of the rack while a low-friction wear-strip facilitates opening
- ✓ Finished in a durable black textured powder coat

### Thermal Management

- ✓ Center section features laser knockouts for two 4½" fans, top and bottom

### Cable Management

- ✓ Abundant cable tie-points located throughout the rack and on the backpan to facilitate cable management
- ✓ UHF/VHF, 2½", 3", 4", 4" x 8", UCP connector and Wiremold 4000® knockouts provided for cable management
- ✓ Laser knockouts on both sides of bottom cable entry platform allow simplified cable pass-through with an attractive shroud to conceal conduit stubs and low voltage cabling drops
- ✓ Large opening in the backpan provides a 12½" x 12½" pull-box sized opening for cable passage

### Time Savings

- ✓ Tool-Free Quick-Mount™ system for easy mounting of the center section to the backpan on the jobsite
- ✓ Standard adjustable front 11-gauge, 10-32 threaded rackrail with marked rackspace increments to speed equipment mounting

### Code Compliancy

- ✓ Grounding/bonding stud in top and bottom of center section and backpan facilitates proper grounding and bonding of electronic equipment, as per NEBS and NEC standards
- ✓ UL Listed in the US and Canada

UL LISTED

TIA/EIA COMPLIANT

US PATENT #7,278,183

A&E SPEC. # 96-045B

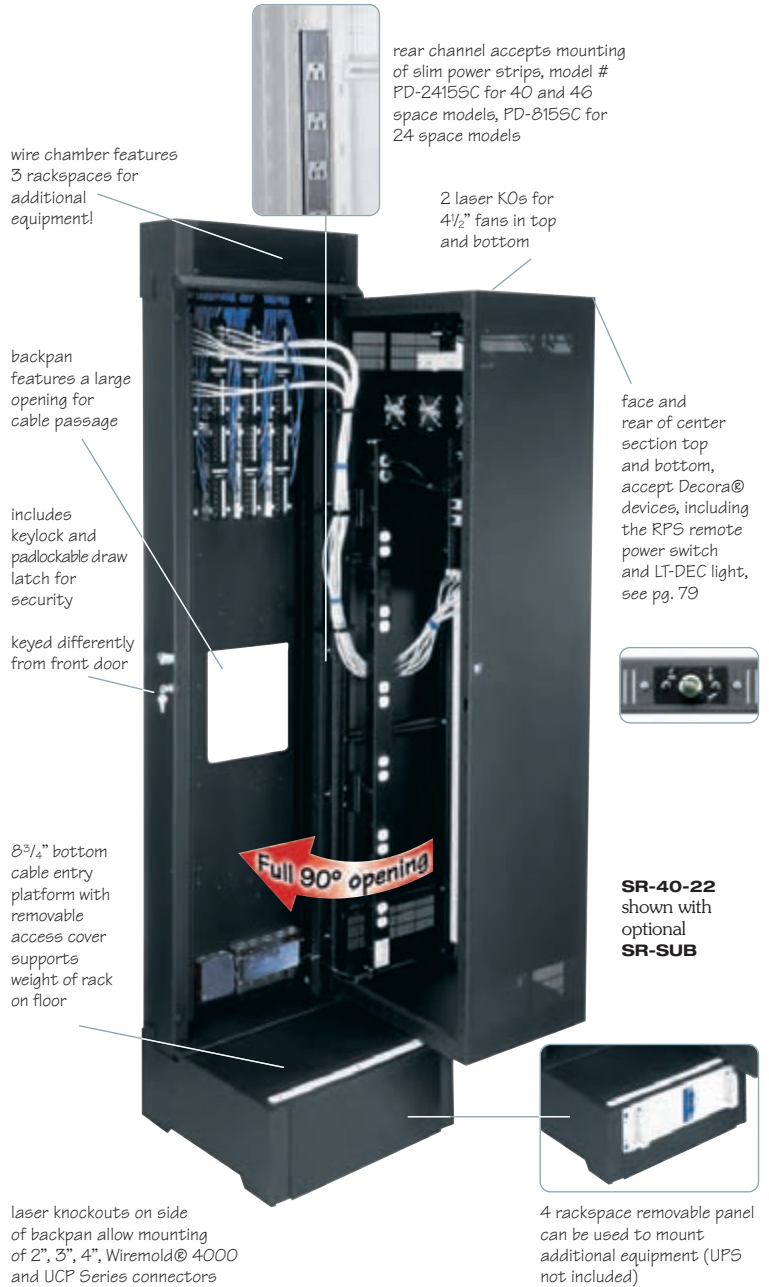

| Part #   | Racking Height  | Useable Depth | Overall Depth | Weight Capacity | Overall Height | Recommended Power* |
|----------|-----------------|---------------|---------------|-----------------|----------------|--------------------|
| SR-24-28 | 42" (24 space)  | 26"           | 28"           | 500 lbs.        | 62¾"           | C E G J            |
| SR-24-32 | 42" (24 space)  | 30"           | 32"           | 500 lbs.        | 62¾"           | C E G J            |
| SR-40-22 | 70" (40 space)  | 20"           | 22"           | 500 lbs.        | 90¾"           | N P T              |
| SR-40-28 | 70" (40 space)  | 26"           | 28"           | 500 lbs.        | 90¾"           | N P T              |
| SR-40-32 | 70" (40 space)  | 30"           | 32"           | 500 lbs.        | 90¾"           | N P T              |
| SR-46-28 | 80½" (46 space) | 26"           | 28"           | 500 lbs.        | 101¼"          | N P T V            |

\* NOTE: When mounting vertical power strips in this rack part #PB-DWR is required, see pg. 69, unless mounting N PD-2415SC or C PD-815SC in rear channel. See pgs. 64-79 for complete list of power products.

# SR Series Pivoting Rack Options

## Easy Access Option

US PATENT # 7,188,570

**Part #**  
DWRSR-ZL

**Zero Clearance Latch**  
Front mounted Zero Clearance Latch saves valuable wall space by allowing wall racks to be placed side-by-side, in a corner, or wherever side clearance is an issue. This easy to install option upgrades new SR Series racks to allow the center section to lock without the need for side latches - to open, simply pull the convenient front-mounted handle. Unlike time-consuming threaded rods, this unique latch provides keylocked security from the front (keyed differently from optional front door).  
**Available only from Middle Atlantic Products!**

## Tool-Free Quick-Mount™ System

US PATENT # 7,278,183

enables easy installation of center section to backpan

4" KO  
UKF/VHF KO  
UCP connector panel KO  
Wiremold® 4000 KO  
3" KO  
center section  
2 1/2" KO  
4" x 8" panel

**NO TOOLS REQUIRED**

## Door and Additional Threaded Rackrail Options

| Rack Part # | Solid Front Door | Plexi Front Door | 25% Open Area Front Door | 64% Open Area Front Door | Add'l 10-32 Threaded Rackrail |
|-------------|------------------|------------------|--------------------------|--------------------------|-------------------------------|
| SR-24-xx    | FD-24            | PFD-24           | VFD-24                   | LVFD-24                  | DWR-RR24                      |
| SR-40-xx    | FD-40            | PFD-40           | VFD-40                   | LVFD-40                  | DWR-RR40                      |
| SR-46-28    | FD-46            | PFD-46           | VFD-46                   | -                        | DWR-RR46                      |

## Center Section Clearance

13.56"/19.56"/23.56"

32.43"/36.46"/39.48"

SR-xx-22/  
SR-xx-28/  
SR-xx-32

## Power Distribution

UL LISTED SR

**PD-2415SC-NS/PD-2420SC-NS** 24 outlet power strip mounts in center section rear channel of 40 and 46 space SRs, **PD-815SC** for 24 space SRs to save space

## Remote Power Switch

RPS Series remote power switch provides remote power control of system within enclosure, mounts in face, top and bottom, see pg. 79

## Sub-Plate Mounting Kit

89-D bracket (not included)

**SR-SUB**

optional sub-plate mounting kit (SR-SUB) allows for the mounting of up to (4) 89-D type brackets, (4) 1900 boxes or (1) Raco 3 gang box. Mount up to (4) SR-SUB's to each 40 or 46 space SR Series backpan, and up to (2) in each 24 space SR Series backpan

## Grommets

**GK-4G** **GK4**

**GK-4G** gland grommet. Hugs cables to reduce dust and control airflow within an enclosure, sold in packs of 4. Standard **GK** ganging grommet also available, see pg. 112

## Vent Blockers

**VBK** vent blockers available for Active thermal management, see pg. 85

## Decora® Mount LED Light

**LT-DEC** fits in Decora® opening, see pg. 79

## Fans

**FAN** 4 1/2" fans mount in SR center section top, see pg. 82

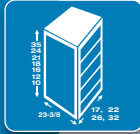

# DWR Series Wall Cabinet

## Wall Mount Sectional Cabinet with Enhanced Cable Management

Specify a DWR wall cabinet when floor space is an issue. This pivoting, sectional wall cabinet is ideal for larger systems in both secured and non-secured areas.

### Structural Features

- ✓ Zero Clearance Latch option allows side-by-side or interior corner mounting
- ✓ New center section rear channel accommodates slim power to save space
- ✓ Welded construction provides up to a 300 lb. weight capacity, depending on model
- ✓ Reversible padlockable center section is keyed differently from optional front door for security
- ✓ Finished in a durable black or granite gray textured powder coat

### Thermal Management

- ✓ Additional cooling is facilitated by installing optional 4½" fans into laser knockouts in top and bottom of pivoting section, up to 4 total, and is optimized by using optional vent blockers

### Cable Management

- ✓ ½", ¾", 1", 1½", 2" and 3" electrical knockouts on top and bottom, top knockout plate additionally contains UHF/VHF antenna knockouts
- ✓ 2" knockouts, 4" knockouts for Wiremold 4000® Series raceways, and knockouts for UCP Series universal connector panels on side (see pgs. 128-129)
- ✓ Abundant lacing points throughout the interior facilitate cable management
- ✓ Large laser knockout in backpan provides an easily removable 12½" x 12½" pull-box sized opening for cable passage

### Time Savings

- ✓ Tool-Free Quick-Mount™ system for easy, one-person mounting of the center section to the backpan on the jobsite
- ✓ Standard adjustable front 11-gauge, 10-32 threaded rackrail with marked rackspace increments to speed equipment mounting
- ✓ Raised mounting points on backpan accept power and other accessories

### Code Compliancy

- ✓ Grounding/bonding stud in top and bottom of center section and backpan facilitates proper grounding and bonding of electronic equipment, as per NEBS and NEC standards
- ✓ UL Listed in the US and Canada

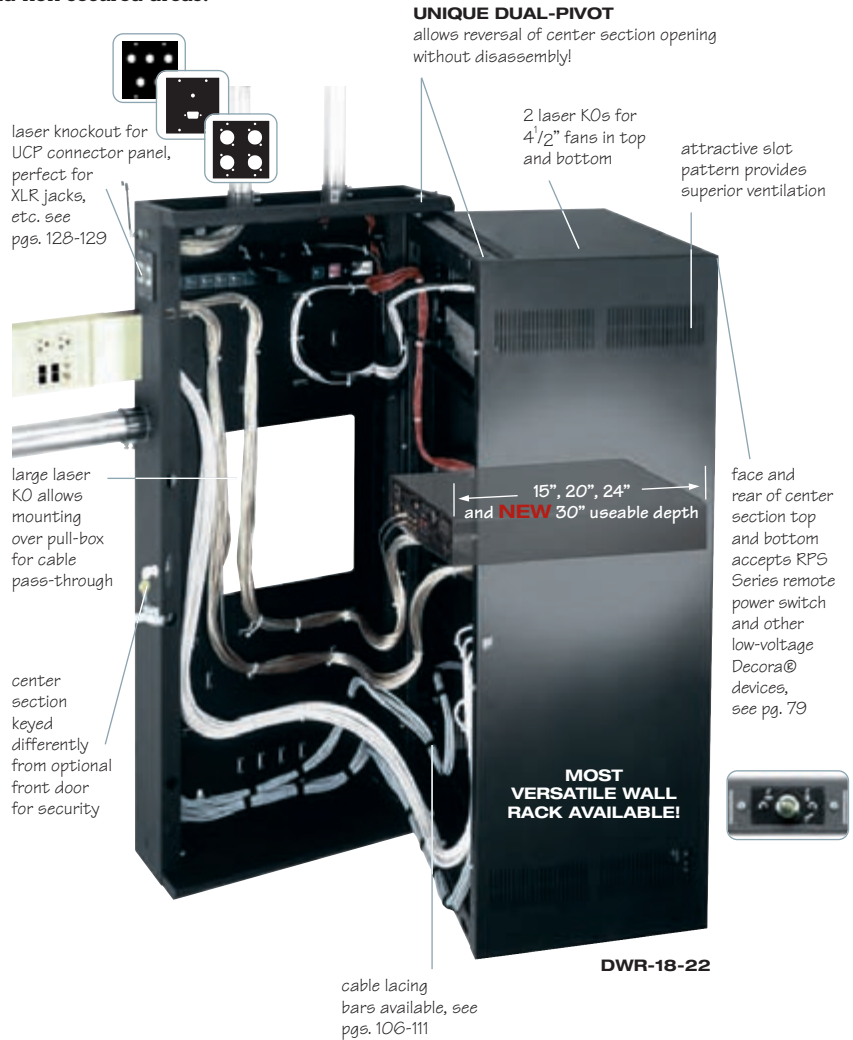

UL LISTED  
TIA/EIA COMPLIANT  
US PATENT #7,278,183

A&E SPEC.  
# 96-045

| 17" Deep<br>(15" Useable)<br>Part #** | 22" Deep<br>(20" Useable)<br>Part #** | 26" Deep<br>(24" Useable)<br>Part #** | 32" Deep<br>(30" Useable)<br>Part #** | Fully Assembled with Plexi Front Door |                                       |                                       | Racking Height  | Weight Capacity | Overall Height | Recommended Power* |
|---------------------------------------|---------------------------------------|---------------------------------------|---------------------------------------|---------------------------------------|---------------------------------------|---------------------------------------|-----------------|-----------------|----------------|--------------------|
|                                       |                                       |                                       |                                       | 17" Deep<br>(15" Useable)<br>Part #** | 22" Deep<br>(20" Useable)<br>Part #** | 26" Deep<br>(24" Useable)<br>Part #** |                 |                 |                |                    |
| DWR-35-17                             | DWR-35-22                             | DWR-35-26                             | -                                     | -                                     | DWR-35-22PD                           | DWR-35-26PD                           | 61¼" (35 space) | 300 lbs.        | 68⅞"           | C G J N            |
| DWR-24-17                             | DWR-24-22                             | DWR-24-26                             | DWR-24-32                             | DWR-24-17PD                           | DWR-24-22PD                           | DWR-24-26PD                           | 42" (24 space)  | 300 lbs.        | 49⅞"           | C E G J            |
| DWR-21-17                             | DWR-21-22                             | -                                     | -                                     | DWR-21-17PD                           | DWR-21-22PD                           | -                                     | 36¾" (21 space) | 250 lbs.        | 43⅞"           | C E G              |
| DWR-18-17                             | DWR-18-22                             | DWR-18-26                             | DWR-18-32                             | -                                     | -                                     | DWR-18-26PD                           | 31½" (18 space) | 250 lbs.        | 38⅞"           | C E                |
| DWR-16-17                             | DWR-16-22                             | -                                     | -                                     | DWR-16-17PD                           | DWR-16-22PD                           | -                                     | 28" (16 space)  | 200 lbs.        | 35⅞"           | C                  |
| DWR-12-17                             | DWR-12-22                             | DWR-12-26                             | DWR-12-32                             | -                                     | -                                     | DWR-12-26PD                           | 21" (12 space)  | 200 lbs.        | 28⅞"           | C                  |
| DWR-10-17                             | DWR-10-22                             | -                                     | -                                     | DWR-10-17PD                           | DWR-10-22PD                           | -                                     | 17½" (10 space) | 200 lbs.        | 24⅞"           | C                  |

\*\*NOTE: To order with granite gray finish, suffix part #'s with GY. See pgs. 64-79 for complete list of power products.

• **C** Models mount in backpan or rear channel, all other models require PB-DWR, see pg. 69. 35 space DWRs mount PD-2415SC in rear channel.



# DWR Series Wall Cabinet Options

## Easy Access Option

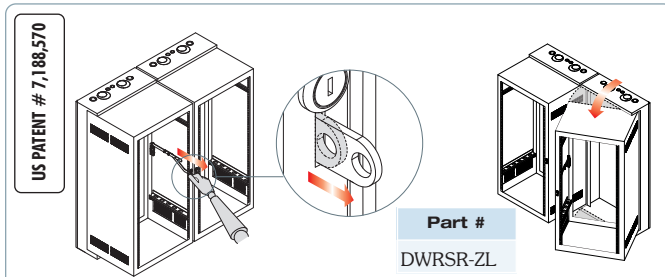

### Zero Clearance Latch

Front mounted Zero Clearance Latch saves valuable wall space by allowing wall racks to be placed side-by-side, in a corner, or wherever side clearance is an issue. This easy to install option upgrades new DWR Series racks to allow the center section to lock closed without the need for side latches - to open, simply pull the convenient front-mounted handle. Unlike time-consuming threaded rods, this unique latch provides keylocked security from the front (keyed differently from optional front door).

**Available only from Middle Atlantic Products!**

## Tool-Free Quick-Mount™ System

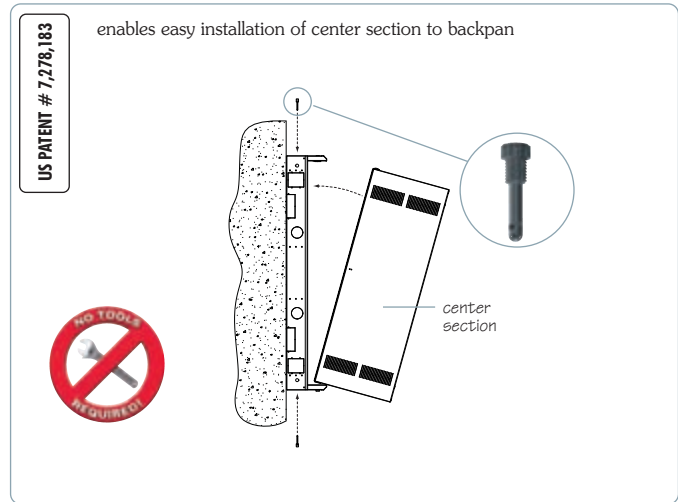

## Door and Additional Threaded Rackrail Options

| Rack Part #        | Solid Front Door | Plexi Front Door | 25% Open Area Front Door | 64% Open Area Front Door | Add'l 10-32 Threaded Rackrail |
|--------------------|------------------|------------------|--------------------------|--------------------------|-------------------------------|
| DWR-35-17/22/26    | FD-35            | PFD-35           | VFD-35                   | LVFD-35                  | DWR-RR35                      |
| DWR-24-17/22/26/32 | FD-24            | PFD-24           | VFD-24                   | LVFD-24                  | DWR-RR24                      |
| DWR-21-17/22       | FD-21            | PFD-21           | VFD-21                   | LVFD-21                  | DWR-RR21                      |
| DWR-18-17/22/26/32 | FD-18            | PFD-18           | VFD-18                   | LVFD-18                  | DWR-RR18                      |
| DWR-16-17/22       | FD-16            | PFD-16           | VFD-16                   | LVFD-16                  | DWR-RR16                      |
| DWR-12-17/22/26/32 | FD-12            | PFD-12           | VFD-12                   | LVFD-12                  | DWR-RR12                      |
| DWR-10-17/22       | FD-10            | PFD-10           | VFD-10                   | LVFD-10                  | DWR-RR10                      |

## Power Distribution

**PB-DWR** required for mounting standard chassis PD Series and MPR power strips vertically in back pan

quick-clip (included with power strips)

mounting and cable management tie-points built-in

backpan includes raised mounting embosses to mount **C** size power and other accessories

**PD-815SC** shown mounted on backpan

power strip mounts in center section rear channel of DWRs to save space

**NEW**

| Size         | Power Strip                           | Qty    |
|--------------|---------------------------------------|--------|
| 10-18 space  | PD-815SC, PD-815SC-NS                 | 1      |
| 21, 24 space | PD-815SC, PD-815SC-NS                 | 1 or 2 |
| 35 space     | PD-2415SC, PD-2415SC-NS, PD-2420SC-NS | 1      |

## Fan Kits include two 4 1/2" fans, four fan guards and vent blockers

| Part #   | Description                 |
|----------|-----------------------------|
| DWR-FK17 | fan kit, fits 17" depth DWR |
| DWR-FK22 | fan kit, fits 22" depth DWR |
| DWR-FK26 | fan kit, fits 26" depth DWR |

## Center Section Clearance

|                          |                         |
|--------------------------|-------------------------|
| DWR-xx-17/<br>DWR-xx-22/ | DWR-xx-26/<br>DWR-xx-32 |
|--------------------------|-------------------------|

## Decora® Mount LED Light

**LT-DEC** fits in Decora® opening, see pg. 79

## Cover Plate

**DWR-CVR** optional cover plate/shelf kit available

## Remote Power Switch

RPS Series remote power switch provides remote power control of system within enclosure, mounts in face, top and bottom, see pg. 79

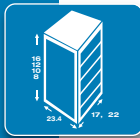

# EWR Series Wall Cabinet

## Aggressively Priced Sectional Wall Cabinet for Smaller Systems

Consider an EWR wall cabinet when installing smaller systems and an economical solution is required. This pivoting, sectional wall cabinet provides unparalleled quality at an aggressive price and is ideal for use in both secured and non-secured areas.

### Structural Features

- ✓ Tool-Free Quick-Mount™ system for easy one-person mounting of the center section to the backpan on the jobsite
- ✓ Welded construction provides a 150 lb. weight capacity
- ✓ Models available with solid locking front door
- ✓ Finished in a durable black textured powder coat
- ✓ Standard 3 position front 1/8", 5/8" and 1 1/8" adjustable 11-gauge, 10-32 threaded rackrail with marked rackspace increments to speed equipment mounting
- ✓ Reversible padlockable center section keyed separately from optional front door

### Thermal Management

- ✓ Vented to facilitate optimum Passive thermal management

### Cable Management

- ✓ 1/2", 3/4", 1" and 1 1/2" electrical knockouts and UHF/VHF antenna knockouts on top and bottom of backpan
- ✓ Abundant lacing points throughout the interior facilitate cable management
- ✓ Large opening in backpan provides a 10 1/2" x 10 1/2" pull-box sized opening for convenient cable passage

### Code Compliancy

- ✓ UL Listed in the US and Canada

### Power

- ✓ Backpan includes integral mounting clips to mount **C** size power strips

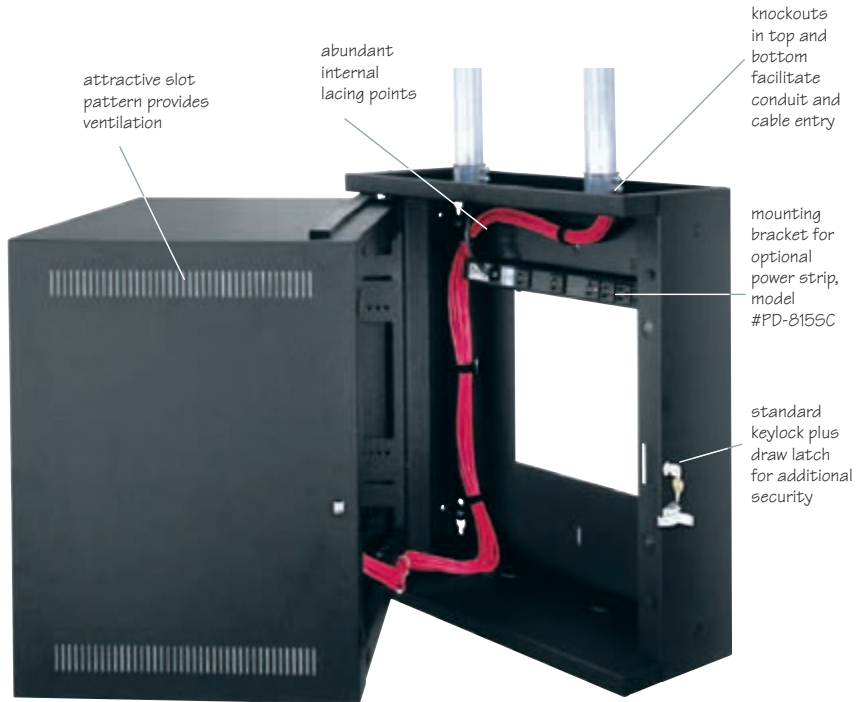

### Rackrail Bracket Extender

Convert the **EWR** to full front to rear adjustable rackrail, includes 4 pieces

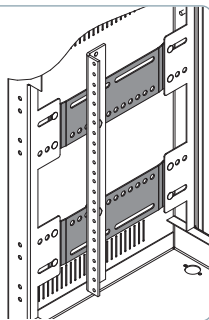

| Part #     | Fits          |
|------------|---------------|
| EWR-ARB-17 | 17" deep EWRs |
| EWR-ARB-22 | 22" deep EWRs |

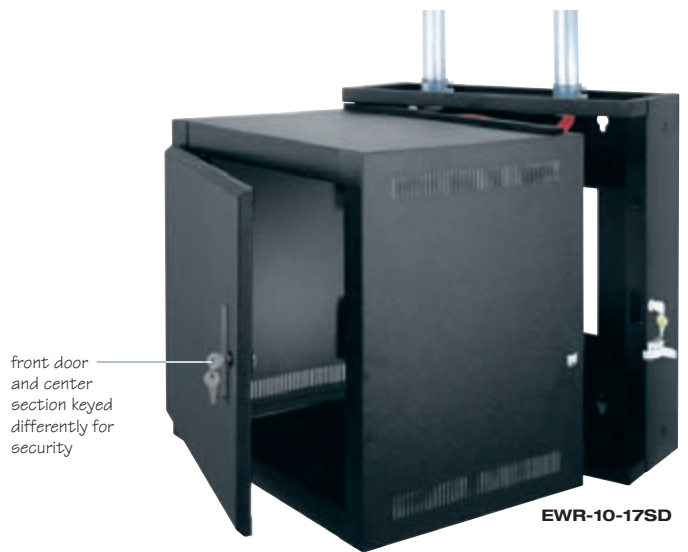

| 17" Deep (15" Useable) Part # | 22" Deep (20" Useable) Part # | With Solid Front Door         |                               | Racking Height     | Weight Capacity | Overall Height | Recommended Power* |
|-------------------------------|-------------------------------|-------------------------------|-------------------------------|--------------------|-----------------|----------------|--------------------|
|                               |                               | 17" Deep (15" Useable) Part # | 22" Deep (20" Useable) Part # |                    |                 |                |                    |
| EWR-16-17                     | EWR-16-22                     | EWR-16-17SD                   | EWR-16-22SD                   | 28" (16 space)     | 150 lbs.        | 35"            | <b>C</b>           |
| EWR-12-17                     | EWR-12-22                     | EWR-12-17SD                   | EWR-12-22SD                   | 21" (12 space)     | 150 lbs.        | 28"            | <b>C</b>           |
| EWR-10-17                     | EWR-10-22                     | EWR-10-17SD                   | EWR-10-22SD                   | 17 1/2" (10 space) | 150 lbs.        | 24 1/2"        | <b>C</b>           |
| EWR-8-17                      | EWR-8-22                      | EWR-8-17SD                    | EWR-8-22SD                    | 14" (8 space)      | 150 lbs.        | 21"            | <b>C</b>           |

See pgs. 64-79 for complete list of power products. • Mounts in backpan only.

# EWR Series Wall Cabinet Options

## Tool-Free Quick-Mount™ System

enables easy installation of center section to backpan

US PATENT # 7,278,183

center section

## Center Section Clearance

8.65"  
13.65"

29.8"  
32.5"

EWR-xx-17/  
EWR-xx-22

## Door and Additional Threaded Rackrail Options

| Rack Part #  | Solid Front Door | Plexi Front Door | Vented Front Door | Add'l 10-32 Threaded Rackrail |
|--------------|------------------|------------------|-------------------|-------------------------------|
| EWR-16-17/22 | FD-16            | PFD-16           | EVFD-16           | DWR-RR16                      |
| EWR-12-17/22 | FD-12            | PFD-12           | EVFD-12           | DWR-RR12                      |
| EWR-10-17/22 | FD-10            | PFD-10           | EVFD-10           | DWR-RR10                      |
| EWR-8-17/22  | FD-8             | PFD-8            | EVFD-8            | DWR-RR8                       |

## Horizontal Lacer Bars - pg. 110

**IMPROVED STRENGTH**

| LBP-1.5  | LBP-1R4  | LBP-1S                               | LBP-1R   | LBP-1A                                    | LBP-2A  | LBP-4A  | LBP-6A  | UP1P                                    | LBP-LTF                                 |
|--|--|--------------------------------------|--|---|---|---|---|---|---|
| 1.5" offset round rod w/ flattened ends, sold in packs of 10 | 4" offset round rod w/ flattened ends, sold in packs of 10 | rectangular bar, sold in packs of 10 | round rod w/ flattened ends, sold in packs of 10 | "L" shaped lacer bar, sold in packs of 10 | "L" shaped 2" offset lacer bar, sold in packs of 10 | "L" shaped 4" offset lacer bar, sold in packs of 10 | "L" shaped 6" offset lacer bar, sold in packs of 10 | 1 space lacer panel sold in packs of 10 | 2 space lacer panel sold in packs of 10 |

## Power Distribution

see pgs. 96-109 for full power products listing

**PD-815SC**  
8 outlet 15 Amp vertical power strip with 9' cord

**PDLT-815RV-RN**  
rack light with 15 Amp power distribution, 8 outlets total, includes 2 stage surge suppression and remote notification

## Grommet Kit - pg. 112

**GR-30** flexible grommet for KOs protects cables

## Cover Plate

**DWR-CVR** optional cover plate/ shelf kit available

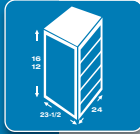

# IDF Series Intermediate Distribution Rack

## Intermediate Distribution Rack Mounts to Building Truss

Choose the IDF when rackmounting hubs, routers and other equipment overhead in warehouses, retail outlets or any larger, open location

### Structural Features

- ✓ Mounts to building truss or unistrut® using 1/2" threaded rods (installer supplied), or directly to unistrut®
- ✓ Welded construction provides 150 lb. weight capacity
- ✓ Included safety lanyard ensures a secure installation
- ✓ Removable 16-gauge aluminum plate allows bottom mounting of wireless antennae, dome cameras, etc.
- ✓ Standard solid front and rear locking and latched doors install with safety chains and lift-off stops to prevent accidental removal
- ✓ Electrical box pre-installed inside the enclosure
- ✓ Standard front and rear adjustable 11-gauge, 10-32 threaded rackrail with numbered rackspace increments
- ✓ Finished in a durable black textured powder coat

### Thermal Management

- ✓ Two 4 1/2" exhaust fans remove heated air at the top of the enclosure. Passive lower air intakes allow cooler air to be pulled in from the bottom.

### Cable Management

- ✓ Rack top includes four integral gland grommeted 4" cable pass-throughs
- ✓ Multiple UHF/VHF antenna knockouts on the bottom of the enclosure

### Code Compliancy

- ✓ Grounding/bonding stud in top of enclosure facilitates proper grounding and bonding of electronic equipment, as per NEBS and NEC standards
- ✓ UL Listed in the US and Canada

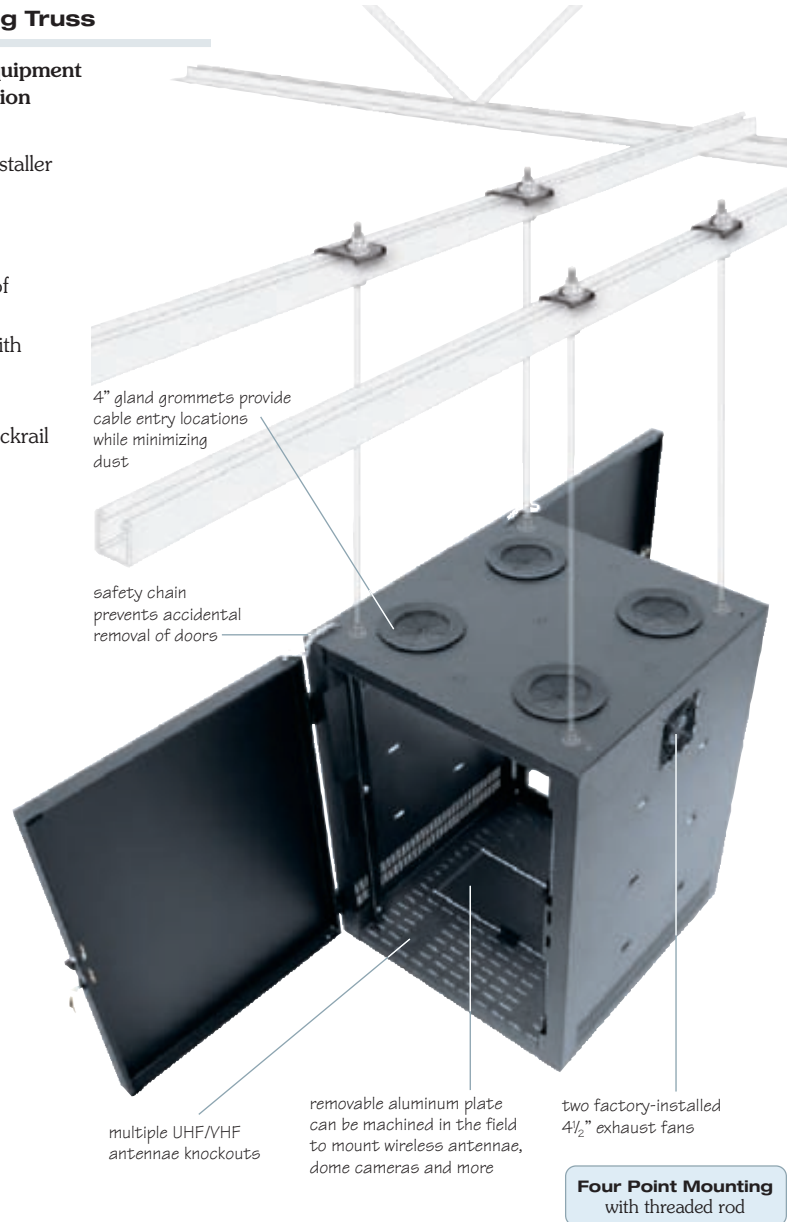

| Part #        | Description  |
|---------------|--|
| IDF-TM-1224BK | 12 space, 24" deep, 21" useable depth  |
| IDF-TM-1624BK | 16 space, 24" deep, 21" useable depth  |
| IDF-ARB-24    | optional rackrail bracket extender, converts IDF to full front to rear adjustable rackrail |

includes power distribution unit - at no extra charge! See pg. 77 for more on the **PD-915R**.

## Alternate Mounting Methods

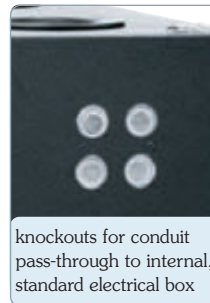
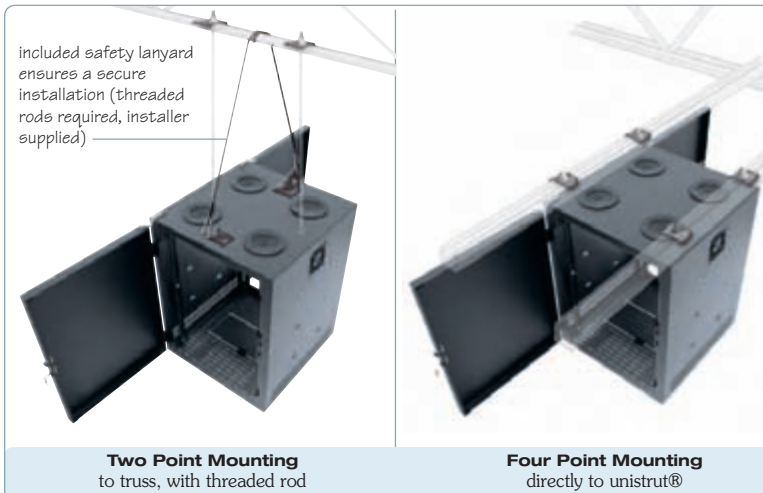

UL US LISTED  
TIA/EIA COMPLIANT  
A&E SPEC. # 96-01075

# Digital Video and Time-Lapse Recorder Lockboxes

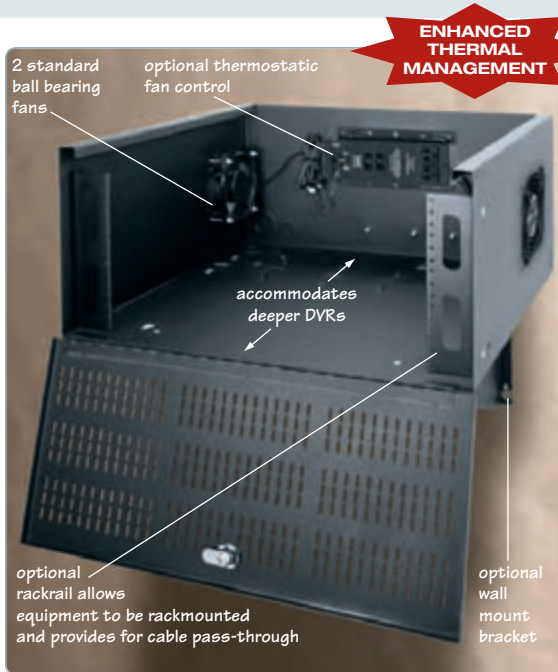

**ENHANCED THERMAL MANAGEMENT**

UL LISTED  
cUL US LISTED

A&E SPEC.  
# 96-01008

## Protect The Evidence!

### Specify a DLBX when securing digital recording equipment

- ✓ Optimized to handle the active or passive thermal management needs of digital video recorders and other digital equipment
- ✓ Mounts vertically or horizontally to the wall, also can be used as a monitoring shelf
- ✓ Configurable thermal management system includes two fans, and can be set up to accommodate the needs of any DVR or NVR
- ✓ Optional proportional speed thermostatic fan control ensures fan only runs when needed, increasing fan life and reducing maintenance requirements & noise
- ✓ Extensive cable management facilities include tie points, EKO's and cable pass-throughs
- ✓ Mechanically interlocking top provides added security yet removes easily for equipment servicing
- ✓ Standard keylocked solid hinging front door allows easy equipment access
- ✓ 100 lb. weight capacity
- ✓ UL Listed in the US and Canada

| Part #      | Description   | Inside Dimensions  | Outside Dimensions  |
|-------------|---|--|---|
| DLBX        | DVR/NVR lockbox w/fan   | 22 <sup>7</sup> / <sub>8</sub> "w x 11"h x 26 <sup>3</sup> / <sub>4</sub> "d | 23 <sup>3</sup> / <sub>8</sub> "w x 11 <sup>1</sup> / <sub>2</sub> "h x 28 <sup>1</sup> / <sub>4</sub> "d |
| DLBX-WM     | pair of wall mount brackets for DLBX  |  |   |
| DLBX-RR5    | 10-32 threaded rackrail kit for DLBX, 5 sp. with cutouts for cable pass-through |  |   |
| FC-2-215-1C | proportional speed thermostatic fan control with two 15 Amp outlets             |  |   |

DLBX shown with mechanically interlocking cover removed



DLBX shown mounted flush to the wall



FC-2-215-1C optional proportional speed thermostatic fan control with two 15 Amp outlets

## Sample Thermal Management Configurations

Visit [middleatlantic.com](http://middleatlantic.com) for more configurations

### DVR with side intake and rear exhaust

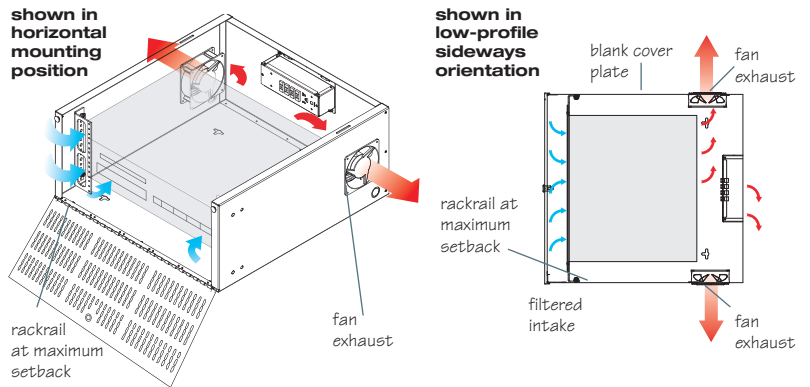

DLBX shown with optional Thermostatic Fan Control, part # FC-2-215-1C

DLBX shown with optional Thermostatic Fan Control, part # FC-2-215-1C

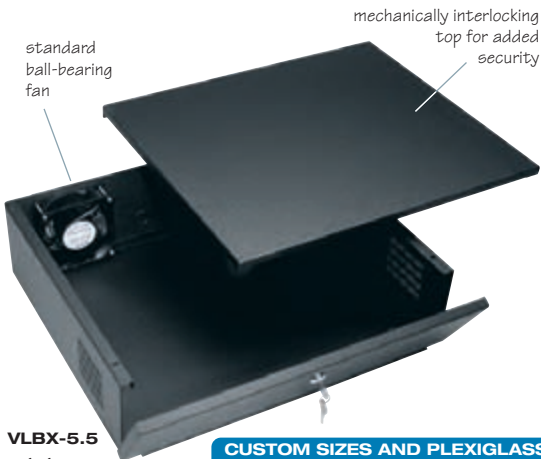

VLBX-5.5 includes a removable, washable filter

**CUSTOM SIZES AND PLEXIGLASS FRONT PANEL AVAILABLE**  
Please call 800-266-7225 for details.

A&E SPEC.  
# 96-942

## VLBX Series Time-Lapse Recorder Lockboxes

### Specify a VLBX when high security is a priority and ease of equipment access is essential

- ✓ Fully welded 16-gauge steel construction for strength
- ✓ Mechanically interlocking top provides added security yet removes easily for equipment servicing
- ✓ Factory-installed 4<sup>1</sup>/<sub>2</sub>" fan with washable filter for effective thermal management
- ✓ Standard keylocked solid hinging front door allows easy equipment access

| Part #   | Description  | Inside Dimensions   | Outside Dimensions   |
|----------|--|---|--|
| VLBX     | DVR lockbox w/fan  | 20 <sup>5</sup> / <sub>8</sub> "w x 8"h x 20 <sup>3</sup> / <sub>4</sub> "d | 20 <sup>3</sup> / <sub>4</sub> "w x 8 <sup>1</sup> / <sub>8</sub> "h x 20 <sup>7</sup> / <sub>8</sub> "d |
| VLBX-5.5 | DVR lockbox w/fan  | 19 <sup>7</sup> / <sub>8</sub> "w x 5 <sup>3</sup> / <sub>8</sub> "h x 17"d | 20"w x 5 <sup>1</sup> / <sub>2</sub> "h x 17 <sup>1</sup> / <sub>4</sub> "d                              |
| VLBX-WM  | pair of wall mount brackets for VLBX only (not compatible with VLBX-5.5) |   |  |

Custom sizes and plexiglass front panel available. Please call for details.

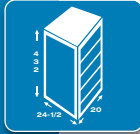

# TOR Series Tilt Out Wall Rack

UL LISTED  
 TIA/EIA COMPLIANT  
 A&E SPEC. # 96-01009

Ideal for small sound systems, paging and patching applications in schools, hotels, offices or anywhere a secure, low-profile wall mount solution is required.

### Structural Features

- ✓ Convenient tip out design allows easy access to equipment controls
- ✓ Two models available: surface mount or flush between studs
- ✓ Tamper resistant design ideal for use in non-secure areas
- ✓ Mount non-rackmount equipment using included clamp bars
- ✓ Rackrail included for use with rackmount equipment
- ✓ Includes electrical box for 120V connections
- ✓ Rackrail is adjustable with a 1/2" to 3" recess to accommodate handles and knobs
- ✓ Available in 2, 3 or 4 rackspace to meet the needs of a wide variety of installations
- ✓ Up to 20" useable depth
- ✓ 100 lb. weight capacity
- ✓ Durable, neutral putty finish complements the aesthetics of most environments

### Thermal Management

- ✓ Engineered to provide effective Passive thermal management

### Cable Management

- ✓ Includes knockout to accommodate Middle Atlantic Products UCP Series universal connector panels, mounts BNC, XLR and other popular connectors, see pgs. 128-129
- ✓ Knockouts provided in back box for cable pass-through
- ✓ Abundant cable management tie points integrated throughout enclosure
- ✓ Decora® knockout provided in face to mount RPS Series remote power switch and other low-voltage Decora® devices

### Code Compliancy

- ✓ Grounding/bonding stud facilitates the proper grounding and bonding of electronic equipment, as per NEBS and NEC standards
- ✓ UL Listed in the US and Canada

knockout accepts RPS Series remote power switch and other low-voltage Decora® style devices, see pg. 79



vented for effective Passive thermal management

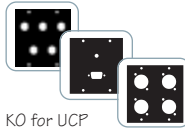

KO for UCP connector panel, perfect for XLR jacks, etc. see pgs. 128-129

removable 8-1/2" x 8-1/2" knockout

clamp bars for securing non-rackmount equipment

rackrail for rackmount equipment



flush mount, shown in service position

### Opens without tools for full access



keylocks closed for security

front panel equipment access

fully open, accessible for servicing

| Surface Mount Part # | Flush Mount Part # | Racking Height   | Maximum Useable Depth | Outside Height | Outside Width | Outside Depth |
|----------------------|--------------------|------------------|-----------------------|----------------|---------------|---------------|
| TOR-2-20SP           | TOR-2-20RP         | 3 1/2" (2 space) | 20"                   | 30 1/4"        | 24 1/2"       | 4 7/16"       |
| TOR-3-20SP           | TOR-3-20RP         | 5 1/4" (3 space) | 20"                   | 30 1/4"        | 24 1/2"       | 6 3/16"       |
| TOR-4-20SP           | TOR-4-20RP         | 7" (4 space)     | 20"                   | 30 1/4"        | 24 1/2"       | 7 15/16"      |

When mounting TOR-3-20RP or TOR-4-20RP between 2x4 studs, order the partial recess trim kit to finish the installation.

| Model   | Description             |
|---------|-------------------------|
| TOR-PRT | partial recess trim kit |



includes electrical box for 120V connections

# Wall Mount Cabinets

locking hinged plexiglass top cover  
adjustable rackrail provides ample room for D-Ring cable managers

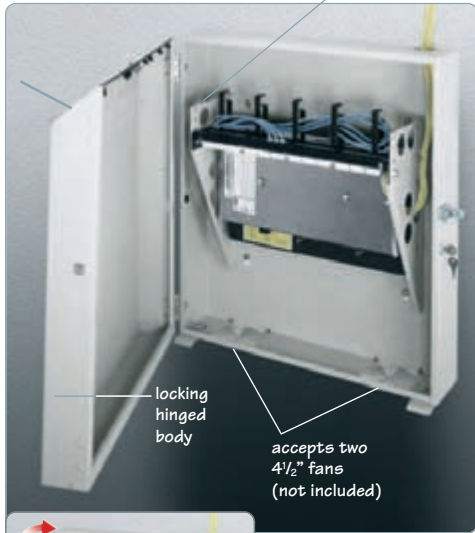

locking hinged body  
accepts two 4 1/2" fans (not included)



vented for cooling  
WRP-6 unique vertical racking provides a generous 23" useable depth  
25 1/4"  
28 1/2"  
WRS-6 shown with top cover open

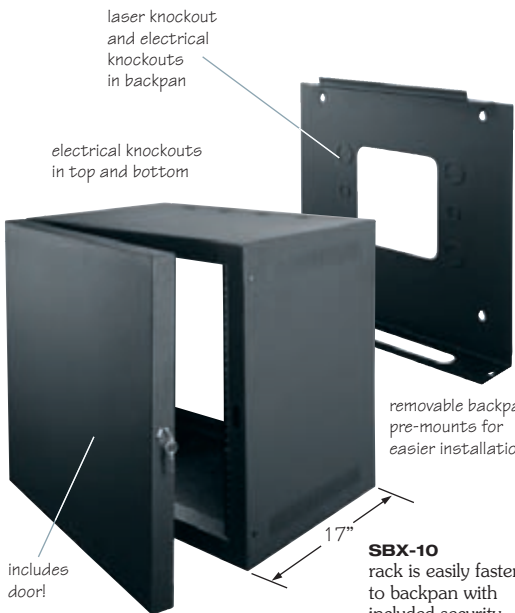

laser knockout and electrical knockouts in backpan  
electrical knockouts in top and bottom  
removable backpan pre-mounts for easier installation  
includes door  
17"  
SBX-10 rack is easily fastened to backpan with included security screws and driver bit

## WRP/WRS Series Low-Profile Wall Cabinets

TIA/EIA COMPLIANT  
UL LISTED

Specify a WRP or WRS when vertically wall mounting deep equipment

### Structural Features

- ✓ Unique design with 23" useable racking depth allows mounting of deeper equipment vertically in a parallel-to-the-wall orientation for space efficiency and aesthetics
- ✓ Standard adjustable 11-gauge, 10-32 threaded rackrail
- ✓ Solid hinged body swings either left or right
- ✓ Angled, hinged plexiglass (WRP Series) or solid steel (WRS Series) top cover allows convenient equipment access
- ✓ Top cover keyed separately from body keylock, providing user access to equipment controls while limiting access to rear equipment connections
- ✓ Finished in a durable putty powder coat (WRP Series) or black textured powder coat (WRS Series)

A&E SPEC. # 96-700

### Thermal Management

- ✓ Vented front and two bottom located fan mounting positions facilitate thermal management

### Cable Management

- ✓ Rackrail adjusts to provide a space from 1" to 4" between top cover and equipment faces, allowing abundant room for D-Ring cable managers

### Code Compliancy

- ✓ Grounding/bonding stud facilitates the proper grounding and bonding of electronic equipment, as per NEBS and NEC standards
- ✓ UL Listed in the US and Canada

| Putty Part # | Black Part # | Racking Height    | Useable Depth | Weight Capacity |
|--------------|--------------|-------------------|---------------|-----------------|
| WRP-4        | WRS-4        | 7" (4 space)      | 23"           | 150 lbs.        |
| WRP-6        | WRS-6        | 10 1/2" (6 space) | 23"           | 150 lbs.        |
| WRP-8        | WRS-8        | 14" (8 space)     | 23"           | 150 lbs.        |

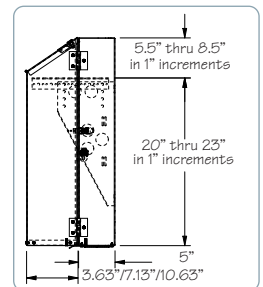

## SBX Series Wall Mount Cabinet

A&E SPEC. # 96-068

Specify an SBX when seeking an economical solution for wall mounting smaller systems.

### Structural Features

- ✓ Removable backpan simplifies installation and provides easy access to equipment connections
- ✓ Fully welded center section utilizes 18-gauge steel, backpan constructed from 14-gauge steel
- ✓ Locking front door swings open a full 180° on a virtually indestructible hinge for rugged security and unobtrusive accessibility
- ✓ Deep rail-to-door clearance ratio provides flexibility not found in flush-mount door designs
- ✓ Standard 11-gauge, 10-32 threaded rackrail with marked rackspace increments to speed equipment mounting

### Thermal Management

- ✓ Ventilation slots at top & bottom of each side promote passive thermal management

### Cable Management

- ✓ 1/2" and 3/4" electrical knockouts at top, bottom and rear facilitate cable entry

| Part # | Racking Height     | Useable Depth | Weight Capacity |
|--------|--------------------|---------------|-----------------|
| SBX-7  | 12 1/4" (7 space)  | 14 3/4"       | 75 lbs.         |
| SBX-10 | 17 1/2" (10 space) | 14 3/4"       | 100 lbs.        |

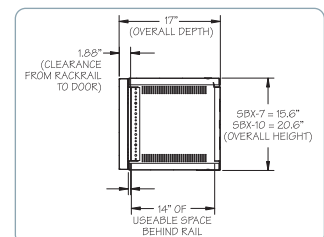

# WR Series Roll Out Rotating System In Steel Host Enclosure

UL LISTED  
TIA/EIA COMPLIANT

A&E SPEC. # 96-01005

## Gain Unrestricted Access to Equipment & Cabling without the Need for Tracks & Stands

Specify a rotating WR Series enclosure when easy access to rear equipment connections is desired for larger audio, video and security equipment installations. Ideal for environments that require equipment bays to be placed up against a wall or back to back. Factory-assembled in its own host enclosure, the rotating roll out system allows entire bays of equipment to roll out and rotate for service and installation flexibility.

### Structural Features

- ✓ 26" and **NEW** 36" useable depth, rack frame is housed in a 32 $\frac{7}{8}$ " or 42 $\frac{7}{8}$ " deep host enclosure
- ✓ 750 lb. weight capacity with proper weight distribution
- ✓ Available in 44, 37 and **NEW** 24 space rack frame heights

### Thermal Management

- ✓ Engineered ventilation locations optimize passive thermal management
- ✓ Configurable open top accepts a number of options for active thermal management

### Cable Management

- ✓ Effective cable management system provided
- ✓ Slots in upper rack frame accommodate Velcro® ties
- ✓ Rack frame features pre-punched rackrail brackets for built-in cable management
- ✓ Laser knockouts provided for cable pass-through and ganging multiple racks

### Time Savings

- ✓ Requires no additional accessories to roll out and rotate
- ✓ Host enclosure can be pre-installed on-site while detachable rack frame is integrated with equipment off-site, simplifying installation
- ✓ Rotating design allows enhanced access to rear equipment connections, simplifying wiring
- ✓ Standard front and rear 11-gauge, 10-32 threaded rackrail with marked rackspace increments speeds equipment mounting, additional rackrail available

### Code Compliance

- ✓ UL Listed in the US and Canada

| 32 $\frac{7}{8}$ " Overall Depth<br>(26" Useable Depth) | 42 $\frac{7}{8}$ " Overall Depth<br>(36" Useable Depth) | Useable Racking Height        | Recommended Power |
|---|---|-------------------------------|-------------------|
| WR-44-32  | <b>NEW</b> WR-44-42                                     | 77" (44 space)                | <b>N P R T</b>    |
| WR-37-32  | <b>NEW</b> WR-37-42                                     | 64 $\frac{3}{4}$ " (37 space) | <b>E G</b>        |
| <b>NEW</b> WR-24-32                                     | -   | 42" (24 space)                |                   |

See pgs. 64-79 for complete list of power products.

**Top Options** most top options feature a removable 2 rackspace service plate



**Unique Feature**  
Rolls out and rotates 60° without the need for any additional accessories!



|   |  |   |   |  |  |  |   |
|---|--|---|---|--|--|--|---|
|   |  |   |   |  |  |  |   |
| <b>MW-ST</b><br>solid <b>MW-LVT</b><br>64% open<br>area <b>MW-VT</b> slot<br>pattern vented | <b>MW-10FT</b><br>(included) mounts one 10" fan<br><b>MW-10FT-550CFM</b><br>with fan <b>MW-10FT-FC</b><br>with fan + control | <b>MW-6FT</b><br>mounts three<br>6" fans<br><b>MW-6FT-660CFM</b><br>with fans | <b>MW-4FT</b><br>mounts four 4 $\frac{1}{2}$ " fans<br><b>MW-4FT-380CFM</b><br>with fans <b>MW-4QFT-FC</b><br>with quiet fans + control | <b>MW-DT</b><br>duct cool<br>adapter<br>see pg. 87 | <b>MW-LA</b><br>accepts<br>6" and 12"<br>cable ladders | <b>MW-TR</b><br>top-mounted<br>rail option,<br>13 spaces | <b>BR2</b><br>2 space brush<br>grommet fits top<br>option opening |

### Options

| Part #   | Solid Front Door* | <b>NEW</b> Plexi Front Door* | Add'l 10-32 Threaded Rackrail | Rear Access Pan |
|----------|-------------------|------------------------------|-------------------------------|-----------------|
| WR-44-xx | WRFD-44           | WR-PFD-44                    | WR-RR-44                      | WR-RAP-44       |
| WR-37-xx | WRFD-37           | WR-PFD-37                    | WR-RR-37                      | WR-RAP-37       |
| WR-24-32 | -                 | -                            | WR-RR-24                      | WR-RAP-24       |

\*provides 3" clearance

### Grommets

**GK-4G** gland grommet. Hugs cables to reduce dust and control airflow within an enclosure, sold in packs of 4. Standard **GK** ganging grommet also available, see pg. 112

### Zero Space Rackshelf

zero space full depth front and rear mount SH Series rackshelf, see pg. 124

**ENHANCED! mounts in any rackspace**

keylocks closed separately from optional front door for safety and security

**WR-44-32** shown in closed and locked position





# AXS Slide Out System In Steel Host Enclosure



**MRK-4426AXS**  
shown extending to  
service position

EIA COMPLIANT SEISMIC CERTIFIED US PATENT #5,443,312

A&E SPEC. # 96-0955

## Gain Unrestricted Access to Equipment and Cabling

Select an AXS when space-limited environments require equipment bays to be placed up against a wall or back to back. A factory-assembled system in an MRK, WRK-SA or ERK enclosure, the patented pull-out design is ideal for access to rear equipment connections. Entire bays of equipment can be rolled out for service and installation flexibility.

### Structural Features

- ✓ Available with 20" and 26" frame depths
- ✓ 650 lb. weight capacity with proper weight distribution
- ✓ Rack frame heights range from 32 to 41 spaces, depending on model
- ✓ Adjustable service stand elevates service tracks to bottom of AXS, allowing it to pull out
- ✓ Host enclosure can be pre-installed on-site while detachable rack frame is integrated with equipment off-site, simplifying installation

### Cable Management

- ✓ Articulating cable carriers attach to rack frame for effective cable management

### Code Compliancy

- ✓ Seismic Certified to the 1997 UBC and 2001 CBC Seismic Zone 4 and the 2000 IBC, 2003 IBC, 2002 ASCE Standard 7 and 2003 NFPA 5000 Seismic Use Group III lateral force requirements for protecting 470 lbs. of essential equipment in upper floor installations with an Ip value of 1.5 (order part # suffixed b "Z4").

\*Service tracks and service stand must be ordered to service the AXS system

| Part #            | Useable Racking Height | Overall Height | Frame Depth | Overall Width | Seismic Certified | Recommended Power |
|-------------------|------------------------|----------------|-------------|---------------|-------------------|-------------------|
| MRK-4426AXS       | 71¾" (41 space)        | 83⅞"           | 20"         | 22"           | No                | <b>N P R T</b>    |
| MRK-4026AXS       | 64¾" (37 space)        | 76⅞"           | 20"         | 22"           | No                | <b>G J N</b>      |
| MRK-3726AXS       | 59½" (34 space)        | 70⅞"           | 20"         | 22"           | No                | <b>E G J</b>      |
| MRK-4431AXS-26    | 71¾" (41 space)        | 83⅞"           | 26"         | 22"           | No                | <b>N P R T</b>    |
| MRK-4031AXS-26    | 64¾" (37 space)        | 76⅞"           | 26"         | 22"           | No                | <b>G J N</b>      |
| MRK-3731AXS-26    | 59½" (34 space)        | 70⅞"           | 26"         | 22"           | No                | <b>E G J</b>      |
| MRK-4426AXS-Z4    | 71¾" (41 space)        | 83⅞"           | 20"         | 22"           | Yes               | <b>N P R T</b>    |
| MRK-4026AXS-Z4    | 64¾" (37 space)        | 76⅞"           | 20"         | 22"           | Yes               | <b>G J N</b>      |
| MRK-3726AXS-Z4    | 59½" (34 space)        | 70⅞"           | 20"         | 22"           | Yes               | <b>E G J</b>      |
| WRK-44SA-27AXS    | 71¾" (41 space)        | 83⅞"           | 20"         | 24¼"          | No                | <b>N P R T</b>    |
| WRK-44SA-32AXS-26 | 71¾" (41 space)        | 83⅞"           | 26"         | 24¼"          | No                | <b>N P R T</b>    |
| ERK-4425AXS       | 71¾" (41 space)        | 81⅞"           | 20"         | 22"           | No                | <b>N P R T</b>    |
| ERK-3525AXS       | 56" (32 space)         | 65⅞"           | 20"         | 22"           | No                | <b>E G J</b>      |

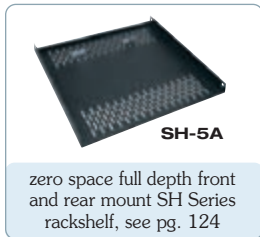

\*NOTE: When mounting vertical power strips in this rack part # PB-5A is required, see pg. 69. See pgs. 64-79 for complete list of power products.

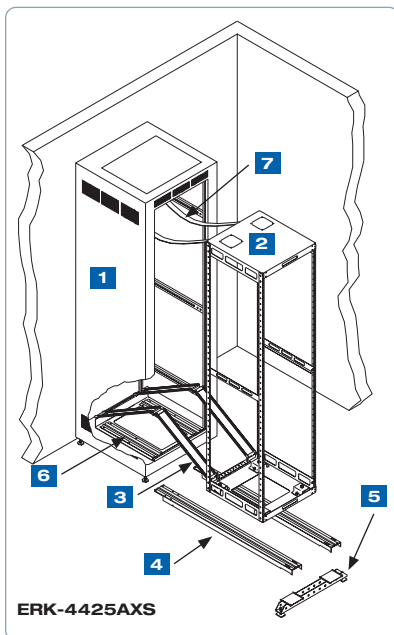

### Service Tracks & Service Stand required for installing & servicing

| Service Tracks <b>4</b> - pair of removable service tracks |                            |                             |
|--|----------------------------|-----------------------------|
| Part # (pair)  | Track Length               | Rack Frame Extension Length |
| TRACK50  | 50"                        | 48"                         |
| Service Stand <b>5</b> - supports & levels service tracks  |                            |                             |
| Part #   | Fits                       |                             |
| TRACKL   | TRACK50 for steel cabinets |                             |

| The Following is Incl. w/ Each of the Above |                                       |
|---|---------------------------------------|
| Qty   | Items Included                        |
| 1   | modified welded cabinet <b>1</b>      |
| 1   | assembled rack frame <b>2</b>         |
| 2   | triple hinged cable carriers <b>3</b> |
| 1   | internal system base <b>6</b>         |
| 2   | top restraining leashes <b>7</b>      |

For information on host cabinets, see pg. 14 (WRK-SA), pg. 18 (MRK), and pg. 24 (ERK).  
NOTE: AXS systems shipped in a host cabinet do not include a rear door.

| Accessories |                                   |
|-------------|-----------------------------------|
| Part #      | Description                       |
| AXS-FAN     | 1 slim-fan for AXS rack, 57 CFM   |
| AXS-FAN-K   | 2 slim-fans for AXS rack, 114 CFM |
| AXS-TEXTRIM | trim panel, textured finish       |

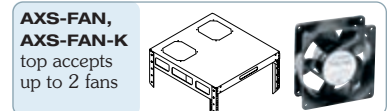

### AXS-WT Cable Management Tray

- ✓ Provides additional capacity for large cable bundles
- ✓ Mounts between cable carriers of any AXS Series slide out rack (non-rotating only)
- ✓ Fits all existing AXS systems

| Part #   | Description   |
|----------|---|
| AXS-WT50 | cable management tray, recommended for high cable density installations |



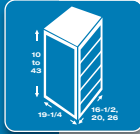

# AXS System For Millwork And In-Wall

## Gain Unrestricted Rear Access To Equipment & Cabling

Specify an AXS when installing audio and video equipment flush into a wall or cabinet, ideal for larger systems. The patented pull-out AXS design is ideal for access to rear equipment connections. Entire bays of equipment can be rolled out for service and installation flexibility.

- ✓ Up to 650 lb. weight capacity with proper weight distribution
- ✓ Rack frame heights range from 10 or 15 spaces to 43 spaces
- ✓ Available with 26", 20" and 16½" frame depths
- ✓ Unique mechanically interlocking corner joint provides exceptional strength and eases assembly
- ✓ Telescoping service stand elevates service tracks to bottom of AXS, allowing it to pull out
- ✓ Articulating cable carriers attach to rack frame for effective cable management (non-rotating models only)
- ✓ Service tracks include built-in level to reduce installation and servicing time
- ✓ Removable rack frame can be integrated off-site to save time
- ✓ Available with Gasket & Guide Kit (requires 19⅝" rough opening width)

US PATENT #5,443,312  
TIME/IEA COMPLIANT

AXS A&E SPEC. # 96-055M

AX-SXR A&E SPEC. # 96-01000

\*Service Tracks and Service Stand must be ordered to service the AXS system

### Ordering Information for Millwork, Custom Cabinet, or In-Wall

| Part #      |   | Ext. Length | Frame Depth | Weight Capacity | Rough Opening Width | Rough Opening Width When Using Gasket & Guide Kit | Rotating |
|-------------|---|-------------|-------------|-----------------|---------------------|---|----------|
| AXS-xx-26** | replace 'xx' w/ the # of useable sp. (15 to 43 sp.) | 48"         | 26"         | 650 lbs.        | 19¼"                | 19⅝"  | no       |
| AXS-xx**    | replace 'xx' w/ the # of useable sp. (15 to 43 sp.) | 48"         | 20"         | 650 lbs.        | 19¼"                | 19⅝"  | no       |
| AX-SXR-xx** | replace 'xx' w/ the # of useable sp. (15 to 43 sp.) | 31"         | 20"         | 450 lbs.        | 19¼"                | 19⅝"  | yes      |
| AX-SX-xx**  | replace 'xx' w/ the # of useable sp. (10 to 43 sp.) | 25"         | 20"         | 650 lbs.        | 19¼"                | 19⅝"  | no       |
| SAX-xx**    | replace 'xx' w/ the # of useable sp. (15 to 43 sp.) | 48"         | 16½"        | 650 lbs.        | 19¼"                | 19⅝"  | no       |
| SSAX-xx**   | replace 'xx' w/ the # of useable sp. (10 to 43 sp.) | 25"         | 16½"        | 650 lbs.        | 19¼"                | 19⅝"  | no       |

\*\*NOTE: to order with Gasket & Guide Kit, suffix part # with '-GG'.

### Service Tracks and Service Stand required for installing and servicing

#### Service Tracks - pair of removable service tracks

| Part # (pair) | Use With            | Track Length | Rack Frame Extension Depth |
|---------------|---------------------|--------------|----------------------------|
| TRACK50       | AXS, SAX, AXS-xx-26 | 50"          | 48"                        |
| TRACK31       | AX-SXR              | 31"          | 31"                        |
| TRACK25*      | AX-SX, SSAX         | 25"          | 25"                        |

\*TRACK25 can only be used with AX-SX and SSAX short extension system.

#### **ENHANCED** Service Stand

#### removable telescoping stand supports & levels service tracks

| Part # | Height Range off the Floor |
|--------|----------------------------|
| TS310  | 3½" to 10"                 |
| TS1022 | 10" to 22"                 |
| TS1640 | 16" to 40"                 |

#### Recommended Power Chart

| Power Strip*   | Size            |
|----------------|-----------------|
| <b>C</b>       | 10 space and up |
| <b>C E</b>     | 17 space and up |
| <b>C E G</b>   | 21 space and up |
| <b>E G J</b>   | 25 space and up |
| <b>G J N</b>   | 35 space and up |
| <b>N P R T</b> | 41 space and up |

NOTE: When mounting vertical power strips, part # PB-5A is required, see pg. 69, **C** also mounts with part # PB-XS. •See pgs. 64-79 for complete list of power products.



installation by Home Systems

AXS shown in open position

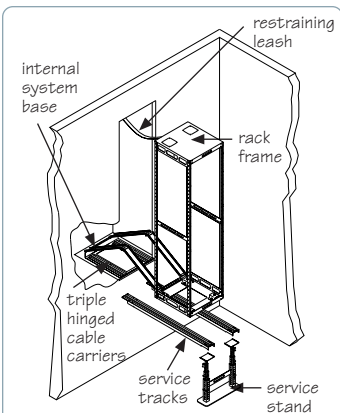

AXS, AX-SX, SAX, SSAX slide out rack (for detailed millwork specifications refer to A&E #96-055M)

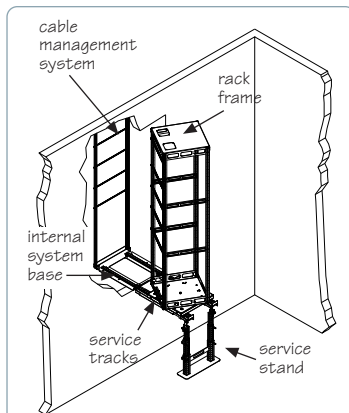

AX-SXR rotating slide out rack (for detailed millwork specifications refer to A&E #96-0100)



AX-SXR rotating slide out rack

# AXS System Options



**AXS-GG20** rack guide protects millwork

**BG17** brush gasket is 1/2" wide, closes gaps

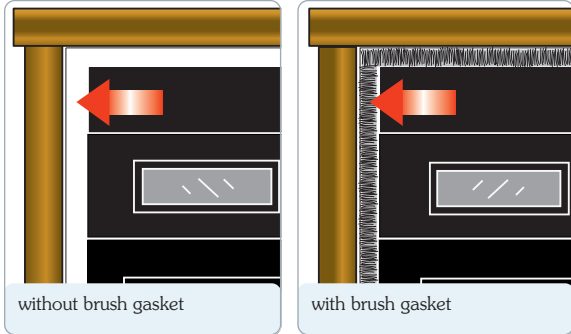

**NOTE:** requires 19<sup>5/8</sup>" rough opening

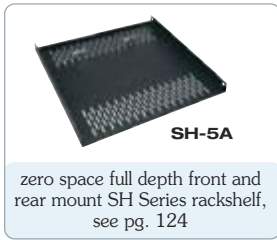

**SH-5A**  
zero space full depth front and rear mount SH Series rackshelf, see pg. 124

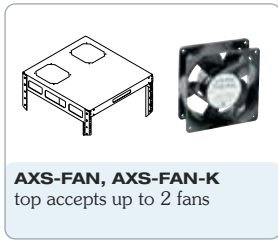

**AXS-FAN, AXS-FAN-K**  
top accepts up to 2 fans

## Gasket & Guide Kit

Attach these guides to upper rack sides on the AXS to ensure the smooth sliding of the rack frame into the millwork, wall or cabinet opening. Ensures frame will remain centered in opening, protecting millwork from damage. Requires a slightly larger rough opening for AXS System, see facing page. Includes BG17 brush gasket strip for front rackrail to fill any gap in wall or millwork opening. Brush gasket retrofits to existing installations. **NOTE:** requires 19<sup>5/8</sup>" rough opening width.

| Part #   | Description        | Fits                 |
|----------|--------------------|----------------------|
| AXS-GG16 | Gasket & Guide Kit | 16" deep AXS         |
| AXS-GG20 | Gasket & Guide Kit | 20" deep AXS, AX-SXR |
| AXS-GG26 | Gasket & Guide Kit | 26" deep AXS         |
| BG17     | 17' brush gasket   | any AXS              |

| Recommended Power Chart |                 |
|-------------------------|-----------------|
| Power Strip*            | Size            |
| <b>C</b>                | 10 space and up |
| <b>C E</b>              | 17 space and up |
| <b>C E G</b>            | 21 space and up |
| <b>E G J</b>            | 25 space and up |
| <b>G J N</b>            | 35 space and up |
| <b>N P R T</b>          | 41 space and up |

**Gasket & Guide Kit**



**NOTE:** When mounting vertical power strips, part # PB-5A is required, see pg. 68, **C** also mounts with part # PB-XS.

•See pgs. 64-79 for complete list of power products.

| Accessories   |  |
|---------------|--|
| Part #        | Description                                |
| AXS-FAN       | 1 slim-fan for AX-SXR rack, 57 CFM         |
| AXS-FAN-K     | 2 slim-fans for AX-SXR rack, 114 CFM       |
| AX-SXR-CATRIM | silver anodized locking trim panel for AXS |

## AXS-WT Cable Management Tray

- ✓ Provides additional capacity for large cable bundles
- ✓ Mounts between cable carriers of any AXS Series slide out rack
- ✓ Fits all existing AXS systems

**NOTE:** not for use with rotating AX-SXR

| Part #   | Fits        |
|----------|-------------|
| AXS-WT50 | AXS, SAX    |
| AXS-WT25 | AX-SX, SSAX |

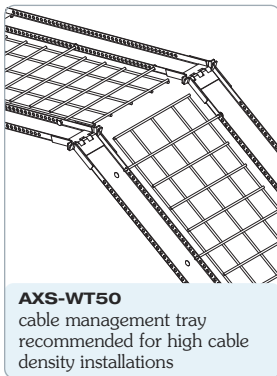

**AXS-WT50**  
cable management tray recommended for high cable density installations



Trim Strips add the finishing touch to any installation, see pg. 120



without trim strip installed



with trim strip installed



# Sliding Rail Systems

## SRSR Series Rotating Sliding Rail System

TIA/EIA COMPLIANT

A&E SPEC. # 96-985

Specify an SRSR for easy rear access to equipment connections in millwork, cabinets and flush in-wall. Available with a 19" or 23" useable depth, the SRSR system extends and rotates 90° in either direction, making it ideal for smaller millwork and in-wall installations.

- ✓ Removable rack frame allows in-shop integration and on-site installation of equipment, saving time in the field
- ✓ Up to a 250 lb. weight capacity, depending on model
- ✓ Sizes range from 12 to 30 spaces
- ✓ Locks in the extended position for simplified equipment integration
- ✓ Rear cable support, when used in conjunction with rear rackrail, provides effective cable management
- ✓ Standard front and rear 11-gauge, 10-32 threaded rackrail with marked rackspace increments to speed equipment mounting
- ✓ Rotating equipment bay locks in place at 0°, 60° and 90° for easy installation and servicing
- ✓ Available model with 23" useable depth for mounting deeper components & clearing deeper setbacks
- ✓ Self-centering mounting base makes it simple to align system within cabinet opening

| Part #   | Description   | Useable Depth |
|--|---|---------------|
| SRSR-2-xx (# of useable spaces, from 12 to 24) | 2 slide 125 lb. capacity  | 19"           |
| SRSR-4-xx (# of useable spaces, from 12 to 30) | 4 slide 250 lb. capacity  | 19"           |
| SRSR-X-xx (# of useable spaces, from 12 to 30) | 4 slide 200 lb. capacity  | 23"           |
| SRSR-CATRIM                                    | silver anodized locking trim panel  |               |
| BG17   | 17' brush gasket, requires 19 <sup>5</sup> / <sub>8</sub> " rough opening |               |

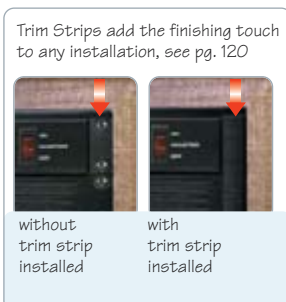
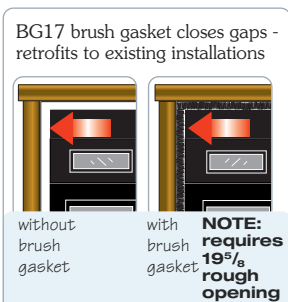
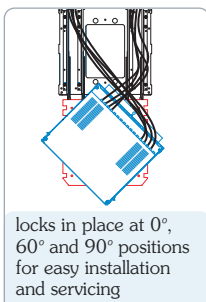
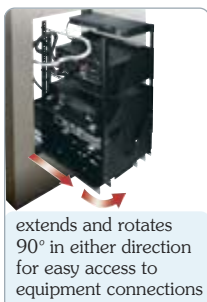
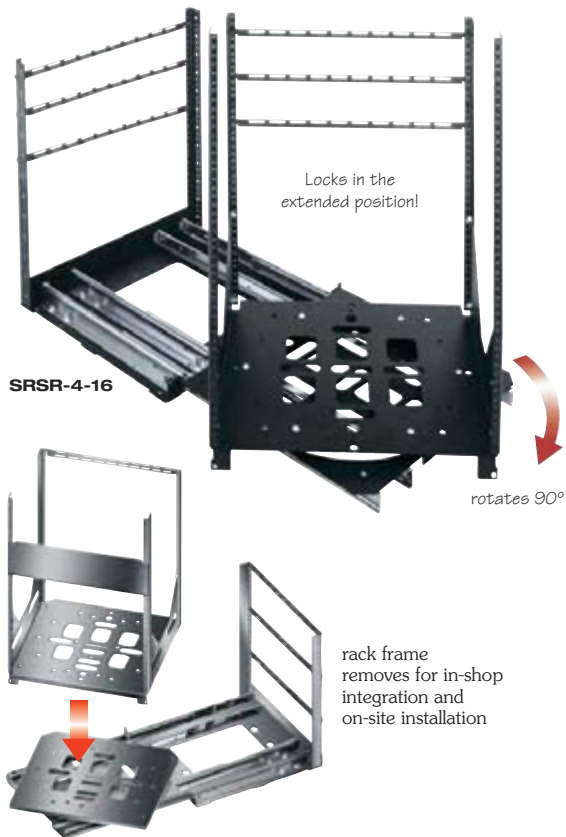

## SRS Series Sliding Rail System

TIA/EIA COMPLIANT

A&E SPEC. # 96-042

Specify an SRS for rear access to equipment connections in millwork & cabinets. System extends a full 19", making it ideal for smaller millwork & in-wall installations.

- ✓ Up to a 250 lb. weight capacity, depending on model
- ✓ Trim panel secures unit closed
- ✓ Sizes range from 8 to 20 spaces
- ✓ Triple-hinged, full-width cable carrier offered for effective cable management
- ✓ Standard front (from 8 to 20 spaces) and rear (7 space) 10-32 threaded rackrail with marked rackspace increments to speed equipment mounting
- ✓ System pulls out a full 19", providing rear access to equipment with shallow depths

| Part #                                      | Description                        |
|---|------------------------------------|
| SRS2-xx (# of useable spaces, from 8 to 20) | 2 slide 125 lb. capacity           |
| SRS4-xx (# of useable spaces, from 8 to 20) | 4 slide 250 lb. capacity           |
| SRCC  | optional cable carrier             |
| SRS-CATRIM                                  | silver anodized locking trim panel |
| BG17  | 17' brush gasket                   |



# 5 Step Guide For Easy Installation Of An In-Wall System

Installing an enclosure in-wall provides an enhanced appearance and occupies minimal space. The guidelines below show the basic steps for preparing to install an in-wall rack. For specific millwork dimensions, consult the appropriate A&E Spec. Sheet, located at [middleatlantic.com](http://middleatlantic.com).

## 1. Cut rough opening one stud width from in-wall stud

- ✓ Refer to appropriate A&E Spec for required rough-in dimensions
- ✓ Ensure that rough-in opening is cut square
- ✓ When cutting flush opening, use one existing stud

**HOT TIP!**

Frame outside of opening with matching jamb, casing or trim to cover rough drywall edge. To ensure proper opening size, take the width of the jamb, casing or trim into account.

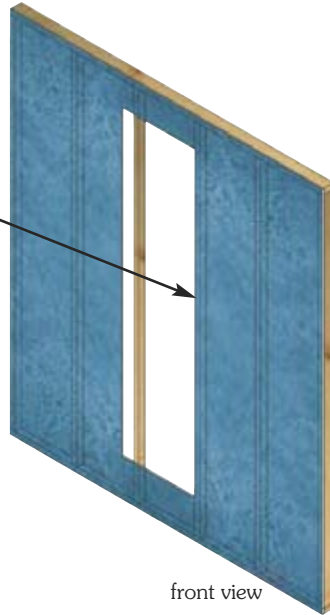

front view

## 2. Cut interfering stud

- ✓ Remove interfering segment of stud when working with common stud spacing of 16" on center

**Important Note:**

Please consult with an architect or engineer before beginning to determine if the wall is load bearing. Load bearing walls may require specific bracing to ensure that all work is structurally sound. Installer is responsible for conformance to local building standards.



rear view

## 3. Install supports

- ✓ Brace opening with a new stud and supports connecting the sides at the top and bottom of the opening
- ✓ Ensure that studs are plumb



rear view

## 4. Build platform

- ✓ Ensure that base is level
- ✓ Base must be built to hold weight of fully-loaded rack, and must be secured to the floor

**Important Note:**

For SRSR, SRS, ASR-HD and ASR slide-out systems, the platform must hold the cantilevered weight of a fully-loaded rack in the extended position. The base must be secured to the floor.



rear view

## 5. Install base

- ✓ Begin installing rack into the opening by securing the base of the rack as shown in the instruction sheet



**AXS Series**  
Slide-Out Rack



**AX-SXR Series**  
Rotating  
Slide-Out Rack



**SRSR Series**  
Rotating Slide-Out  
Rail System



**SRS Series**  
Sliding Rail  
System



**ASR-HD Series**  
Heavy Duty Rotating  
Slide-Out Shelving System



**ASR Series**  
Rotating Slide-Out  
Shelving System



# ASR-HD Series Heavy Duty Rotating Slide Out Shelving System

## ASR-HD Series Combines the Functionality of a Professional Racking System with the Simplicity of Adjustable Shelves

A&E SPEC. # 96-01020

Specify an ASR-HD when installing audio and video equipment in custom cabinetry, entertainment centers and in walls, ideal for smaller systems or when an open shelf system is desired. Slide out and rotating functionality provides enhanced access to rear equipment connections while an aesthetically pleasing design will complement any decor.

- ✓ Ideal for installations when aesthetics are important
- ✓ Quick-Position™ easy index self-leveling shelves are simple to install and are adjustable in 3/4" increments
- ✓ Three sizes accommodate 4, 6 or 9 shelves
- ✓ Self-centering base speeds installation
- ✓ Ships fully assembled to save time
- ✓ Included cable management system facilitates a clean, organized installation
- ✓ Locking detent protects millwork
- ✓ Attractive silver brushed shelf trim can be replaced and customized to match any finish
- ✓ Up to a 250 lb. weight capacity, depending on model

| Part #    | Opening Height | Overall Width | Total Shelves/ Adjustable Shelves | Useable Depth | Weight Capacity |
|-----------|----------------|---------------|-----------------------------------|---------------|-----------------|
| ASR-30-HD | 30"            | 21"           | 4/3                               | 19"           | 200 lbs.        |
| ASR-42-HD | 42"            | 21"           | 6/5                               | 19"           | 200 lbs.        |
| ASR-60-HD | 60"            | 21"           | 9/8                               | 19"           | 250 lbs.        |

| Part #        | Description      | Trim Strip Finish Color |
|---------------|------------------|-------------------------|
| ASR-HD-SH1-SL | additional shelf | silver anodized         |
| ASR-HD-SH1-BK | additional shelf | black anodized          |
| ASR-HD-SH1-WD | additional shelf | unfinished wood         |

### Optional Shelf Trim Kits

Select a black anodized or unfinished wood trim kit to match the decor of any room. Unfinished wood is ready to be stained to match any finish.

| Black Anodized Part # | Unfinished Wood Part # | Fits      |
|-----------------------|------------------------|-----------|
| ASR-30-HDT-BK         | ASR-30-HDT-WD          | ASR-30-HD |
| ASR-42-HDT-BK         | ASR-42-HDT-WD          | ASR-42-HD |
| ASR-60-HDT-BK         | ASR-60-HDT-WD          | ASR-60-HD |



**ASR-HD Series Slide Out Rotating Shelving System**  
mounts in-wall or in entertainment centers



shelves accommodate C power strip PD-815SC-NS



self-centering base speeds installation

high strength shelf mounting pins guaranteed not to sag!

vented shelves and top optimized for ventilation

attractive silver anodized trim panels can be replaced to match any finish

adjustable brackets on shelves secure components to prevent them from sliding backwards

easy index, Quick-Position™ shelves are adjustable in 3/4" increments

locks closed for safety (locking panel included)



shelf fronts feature an attractive silver brushed finish and can be replaced to match any finish



pulls out, rotates 60° and locks in either direction for easy access to equipment connections

# Rotating Slide Out Systems



locks closed for safety (locking panel included)

A&E SPEC. # 96-01026

## ASR Series Economical Rotating Slide Out Shelving System

Specify an ASR when installing audio and video equipment in custom cabinetry, entertainment centers in walls and behind closed doors. Ideal for smaller systems or when an open shelf system is desired and the ability to customize shelf fronts is not required. Slide out and rotating functionality provides enhanced access to rear equipment connections.

- ✓ Self-leveling shelves are simple to install and are adjustable in 3/4" increments
- ✓ Four sizes accommodate 4, 5, 6 or 7 shelves
- ✓ Ships ready-to-assemble to save space
- ✓ Included cable management system facilitates a clean, organized installation
- ✓ Up to a 200 lb. weight capacity, depending on model

| Part # | Opening Height | Overall Width | Total Shelves/ Adjustable Shelves | Useable Depth | Weight Capacity |
|--------|----------------|---------------|-----------------------------------|---------------|-----------------|
| ASR-30 | 30"            | 18 1/4"       | 4/3                               | 16 1/8"       | 100 lbs.        |
| ASR-36 | 36"            | 18 1/4"       | 5/4                               | 16 1/8"       | 100 lbs.        |
| ASR-42 | 42"            | 18 1/4"       | 6/5                               | 16 1/8"       | 200 lbs.        |
| ASR-48 | 48"            | 18 1/4"       | 7/6                               | 16 1/8"       | 200 lbs.        |



**ASR Series Rotating Slide Out Shelving System**  
mounts in-wall or in entertainment centers



Integral cable management system utilizes Velcro® straps for a clean, organized installation



the low-profile Rotating Sliding Base integrates seamlessly within entertainment centers and smaller cabinetry

A&E SPEC. # 96-01064

## REB Series Low Profile Rotating Slide Out Equipment Base

Access cables and equipment connections with the Low-Profile Rotating Slide Out Base. The low-profile design is unobtrusive and elegant in its simplicity while the sturdy construction supports the installation of DVD players, cable or satellite boxes, receivers and other equipment commonly found in entertainment centers and lecterns.

- ✓ Sliding, rotating design provides easy access to cables and equipment connections
- ✓ Ideal for entertainment centers and lecterns
- ✓ Included cable management system facilitates a clean, professional home installation
- ✓ Two depths available to accommodate a wide range of components & cabinets
- ✓ Locks closed for safety

| Part # | Min. Rough Opening Width* | Recommended Rough Opening Min. Depth** | Weight Capacity | Useable Depth   |                 |
|--------|---------------------------|--|-----------------|-----------------|-----------------|
|        |                           |  |                 | With No Setback | With 1" Setback |
| REB14  | 17 1/8"                   | 15"                                    | 75 lbs.         | 13"             | 12"             |
| REB18  | 17 1/8"                   | 19"                                    | 75 lbs.         | 17"             | 16"             |

\*Rough opening will be extended by components wider than 17". \*\*Rough opening depth will be extended by components deeper than the stated useable depth.



**REB Series Rotating Slide Out Base**

slides out and rotates 60° for easy access to cables and connections



also ideal for lecterns



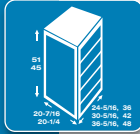

# R4 Series Four Post Open Frame Racks

## Open Frame Four Post Rack with Cage Nut Rackrail

TIME/EA COMPLIANT

US PATENT # 7,219,809

A&E SPEC. # 96-01076

Mount servers and other equipment requiring cage nut mounting hardware with the R4 Series Four Post Open Frame Rack. With the ability to accommodate deeper, heavier components than a two post frame rack, the steel four post design provides a robust 1,000 lb. weight capacity. Open top accepts direct mounting of optional 6", 9" or 12" cable ladder (mounts parallel or perpendicular to front of rack). Standard cage nut Z-rail adaptor enables side mount installations. Ships flat to save space. Includes 100 6mm rack screws and cage nuts. Flat black powder coat finish.

- ✓ Mounts servers using standard, cage nut compliant rackrail
- ✓ Rack gangs to additional four post or two post open frame racks
- ✓ Open frame design facilitates unrestricted air flow
- ✓ Now includes additional, adjustable split rackrail

## Open Frame Four Post Rack with 12-24 Threaded Rackrail

TIME/EA COMPLIANT

US PATENT # 7,219,809

A&E SPEC. # 96-01076

Mount networking, telephone, VOIP equipment, routers, switches and more with the R4 Series Four Post Open Frame Rack. Able to accommodate deeper, heavier components than a two post frame rack, the aluminum four post design provides a 2,500 lb. weight capacity. Open top accepts direct mounting of optional 6", 9" or 12" cable ladder (mounts parallel or perpendicular to front of rack). Ships flat to save space. Includes 100 pcs. of 12-24 threaded mounting hardware. Flat black powder coat finish.

- ✓ Mounts equipment using standard, 12-24 threaded rackrail
- ✓ Rack gangs to additional 4-post or 2-post open frame racks
- ✓ Open frame design facilitates unrestricted air flow
- ✓ Now includes additional, adjustable split rackrail

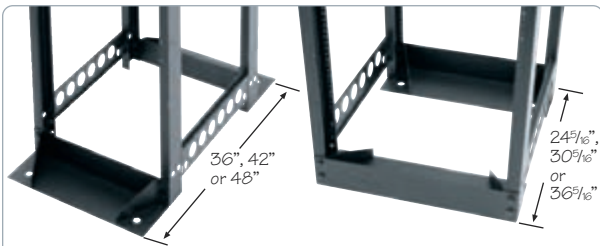

### Versatile Rack Base

base angles may be assembled to the outside for increased stability or inward to save space



numbered rackspace increments speed equipment mounting

| R4 w/ Cage Nut Rackrail (20 1/4" Overall Width) Part # | R4 w/ 12-24 Threaded Rackrail (20 1/4" Overall Width) Part # | Overall Height | Racking Height     | Useable Depth | Recommended Power |
|--|--|----------------|--------------------|---------------|-------------------|
| R4CN-5136B   | -  | 96 1/2"        | 89 1/4" (51 space) | 36"           | G P T             |
| R4CN-4536B   | -  | 84 1/4"        | 78 3/4" (45 space) | 36"           | G P T             |
| R4CN-5130B   | R412-5130B   | 96 1/2"        | 89 1/4" (51 space) | 30"           | G P T             |
| R4CN-4530B   | R412-4530B   | 84 1/4"        | 78 3/4" (45 space) | 30"           | G P T             |
| -  | R412-3830B   | 72 1/4"        | 66 1/2" (38 space) | 30"           | G                 |
| R4CN-5124B   | R412-5124B   | 96 1/2"        | 89 1/4" (51 space) | 24"           | G P T             |
| R4CN-4524B   | R412-4524B   | 84 1/4"        | 78 3/4" (45 space) | 24"           | G P T             |
| -  | R412-3824B   | 72 1/4"        | 66 1/2" (38 space) | 24"           | G                 |

\*See pgs. 64-79 for a complete list of power products.

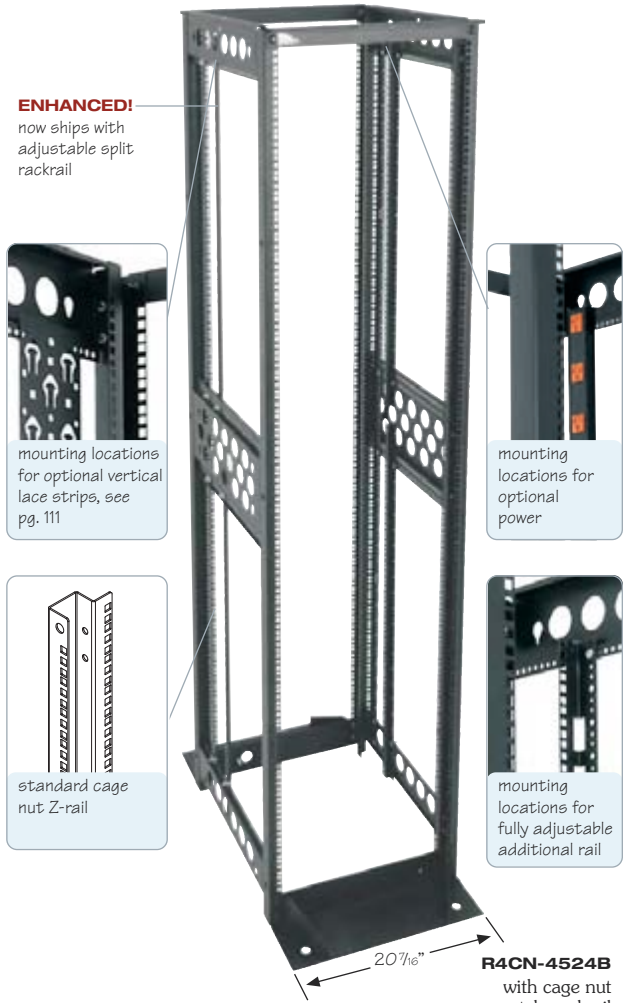

**ENHANCED!**  
now ships with adjustable split rackrail

mounting locations for optional vertical lace strips, see pg. 111

mounting locations for optional power

standard cage nut Z-rail

mounting locations for fully adjustable additional rail

**R4CN-4524B**  
with cage nut style rackrail



**ENHANCED!**  
now ships with adjustable split rackrail

open top accepts optional cable ladder

**R412-4524B**  
with 12-24 threaded rackrail



# R4 Series Four Post Open Frame Racks

## Cable Ladders

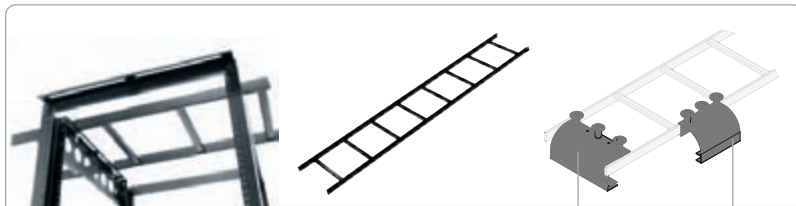

The R4 Series rack accepts mounting of cable ladders parallel or perpendicular to the front of the rack

**CLB-6** cable ladder, 6' long, 12" wide see pg. 114

**CLH-ED11** end cable drop

**CLH-SD8** side cable drop

## Power Distribution and Lighting



vertical and rackmount power and lighting available, please see pgs. 64-79

## Vertical Lacer Strips - see pg. 111

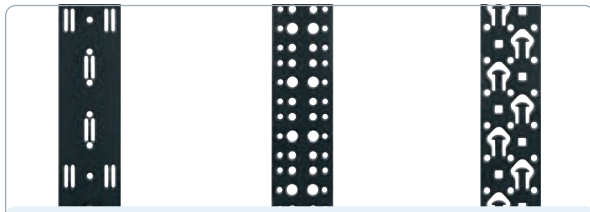

**LACE-44LP**  
44 space  
3 1/2" wide  
lacer strip

**LACE-P**  
45 space  
2" wide  
lacer strip

**LACE-40-OP**  
40 space  
3 1/4" wide  
lacer strip

## Horizontal Lacer Bars - see pg. 110



**LBP-1.5**  
1.5" offset round rod with flattened ends, sold in packs of 10

**LBP-1S**  
rectangular bar, sold in packs of 10

**LBP-1R**  
round rod, sold in packs of 10

**LBP-2A**  
"L" shaped 2" offset lacer bar, sold in packs of 10

**LBP-LTF**  
lacer panel sold in packs of 10

## Side Panels, Cable Ducts with Doors and Additional Rackrail

| R4 w/ Cage Nut Rackrail Part # | R4 w/ Threaded Rackrail Part # | Keylocked Side Panel Pair | 10" Single Cable Duct w/ Doors | 10" Dual Cable Duct w/ Doors | 6" Single Cable Duct w/ Doors | 6" Dual Cable Duct w/ Doors | Add'l 12-24 Threaded Rackrail, Split* | Add'l Cage Nut Rackrail, Split** | Cage Nut Z-Rail Adaptor, Split** |
|--------------------------------|--------------------------------|---------------------------|--------------------------------|------------------------------|-------------------------------|-----------------------------|---------------------------------------|----------------------------------|----------------------------------|
| R4CN-5136B                     | -                              | SPN-R4-5136               | VCD-10-51-SC                   | VCD-10-51-DC                 | VCD-6-51-SC                   | VCD-6-51-DC                 | -                                     | PROR4CN-RR51                     | PROR4CN-ZRA51                    |
| R4CN-4536B                     | -                              | SPN-R4-4536               | VCD-10-45-SC                   | VCD-10-45-DC                 | VCD-6-45-SC                   | VCD-6-45-DC                 | -                                     | PROR4CN-RR45                     | PROR4CN-ZRA45                    |
| R4CN-5130B                     | R412-5130B                     | SPN-R4-5130               | VCD-10-51-SC                   | VCD-10-51-DC                 | VCD-6-51-SC                   | VCD-6-51-DC                 | R412-RR51                             | PROR4CN-RR51                     | PROR4CN-ZRA51                    |
| R4CN-4530B                     | R412-4530B                     | SPN-R4-4530               | VCD-10-45-SC                   | VCD-10-45-DC                 | VCD-6-45-SC                   | VCD-6-45-DC                 | R412-RR45                             | PROR4CN-RR45                     | PROR4CN-ZRA45                    |
| -                              | R412-3830B                     | SPN-R4-3830               | -                              | -                            | VCD-6-38-SC                   | VCD-6-38-DC                 | R412-RR38                             | -                                | -                                |
| R4CN-5124B                     | R412-5124B                     | SPN-R4-5124               | VCD-10-51-SC                   | VCD-10-51-DC                 | VCD-6-51-SC                   | VCD-6-51-DC                 | R412-RR51                             | PROR4CN-RR51                     | PROR4CN-ZRA51                    |
| R4CN-4524B                     | R412-4524B                     | SPN-R4-4524               | VCD-10-45-SC                   | VCD-10-45-DC                 | VCD-6-45-SC                   | VCD-6-45-DC                 | R412-RR45                             | PROR4CN-RR45                     | PROR4CN-ZRA45                    |
| -                              | R412-3824B                     | SPN-R4-3824               | -                              | -                            | VCD-6-38-SC                   | VCD-6-38-DC                 | R412-RR38                             | -                                | -                                |

\*Works with R412 only. \*\*Works with R4CN only.

## Vertical Cable Ducts

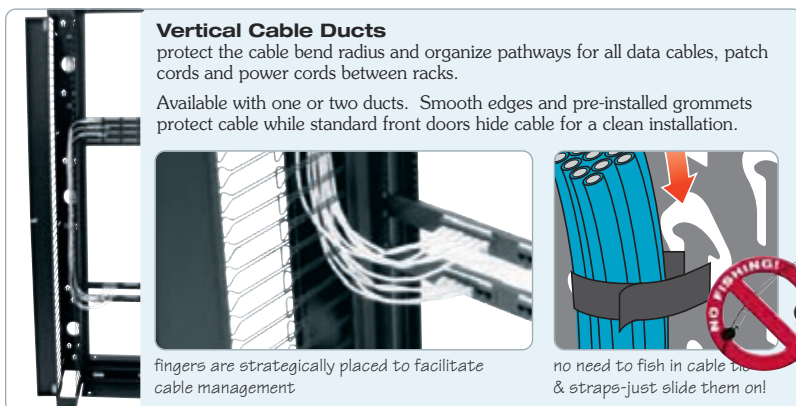

**Vertical Cable Ducts**  
protect the cable bend radius and organize pathways for all data cables, patch cords and power cords between racks.

Available with one or two ducts. Smooth edges and pre-installed grommets protect cable while standard front doors hide cable for a clean installation.

fingers are strategically placed to facilitate cable management

no need to fish in cable ducts & straps-just slide them on!



**R412-4524B** shown with optional **SPN-R4-4524** side panels

# Cable Management And Two Post Open Frame Racks

TIA/EIA COMPLIANT

A&E SPEC. # 96-053

## RL Series Steel Two Post Open Frame Rack

This 19" two post open frame rack incorporates a self-squaring, self-leveling design for easy assembly. Top rails accommodate standard cable ladders and can support a robust 1600 lb. weight capacity when properly loaded and anchored.

- ✓ Comes threaded 10-32 or 12-24, with numbered rackspace increments
- ✓ Channels made from 11-gauge steel to provide extra strength
- ✓ Finished in a black powder coat
- ✓ Includes 50 rack screws

| Part #  | Type         | Overall Height | Racking Height | Weight Capacity | Recommended Power |
|---------|--------------|----------------|----------------|-----------------|-------------------|
| RL10-45 | 10-32 thread | 84"            | 45 space       | 1,600 lbs.      | N P R T           |
| RL10-38 | 10-32 thread | 72"            | 38 space       | 1,600 lbs.      | G J N             |
| RL12-45 | 12-24 thread | 84"            | 45 space       | 1,600 lbs.      | N P R T           |

• When mounting vertical power strips part # PB-5A is required, see pg. 69. See pgs. 64-79 for complete list of power products.

ladder adapter available, see next page for details



horizontal cable managers available, see pg. 113

U2MS mid mount shelf available, see pg. 124

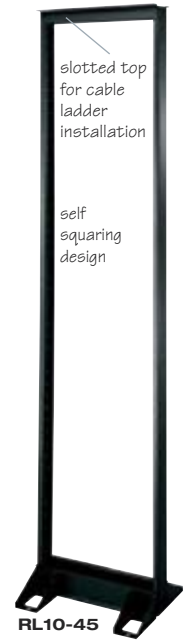
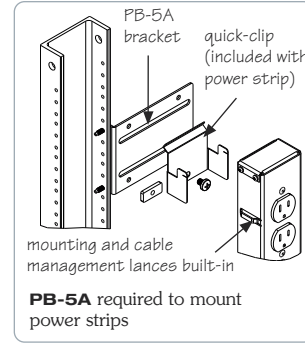
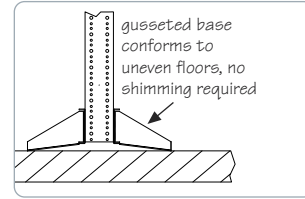



TIA/EIA COMPLIANT

## CSB Cantilever Support Base

Measuring 18" deep, the CSB cantilever support base adds stability to any RL Series Two Post Open Frame Rack. The CSB is especially helpful for installations where flush mounted cantilever shelves are used to mount heavy equipment and the center-of-gravity is shifted to the rear of the rack. Black powder coat finish.

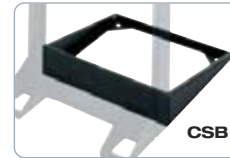
Part #  
CSB



TIA/EIA COMPLIANT

A&E SPEC. # 96-972

## RLA Series Aluminum Two Post Open Frame Rack

Constructed from 3/16" extruded aluminum uprights, the RLA Two Post Open Frame Rack boasts an impressive 1600 lb. weight capacity. The heavy-duty aluminum base is 15" deep and includes holes so that the rack can be secured to the floor.

- ✓ Comes threaded 12-24 front and rear, with numbered rackspace increments
- ✓ Available in silver brushed aluminum or black powder coat finish
- ✓ Includes 25 rack screws

| Part #      | Racking Height | Panel Width | Finish | Recommended Power |
|-------------|----------------|-------------|--------|-------------------|
| RLA19-1251B | 51 space       | 19"         | black  | N P R T           |
| RLA19-1245  | 45 space       | 19"         | silver | N P R T           |
| RLA19-1245B | 45 space       | 19"         | black  | N P R T           |
| RLA23-1245  | 45 space       | 23"         | silver | N P R T           |

• See pgs. 64-79 for complete list of power products. When mounting vertical power strips, part # PB-5A is required, see pg. 69.

12 1/4" more racking height than a standard 78 3/4" open frame rack

**ENHANCED!**

numbered rackspace increments speed equipment mounting

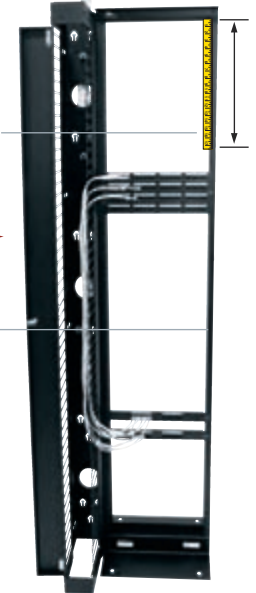

TIA/EIA COMPLIANT

A&E SPEC. # 96-281

## MK Series Cable Management Rack

The MK 19" cable management rack employs an innovative design that incorporates captive fasteners to provide quick assembly times, eliminating loose bolts as well as boasting a 500 lb. or 800lb. weight capacity depending on mounting method. Additional features of the MK include:

- ✓ Unique indexed swiveling front-mount cable rings
- ✓ Oversized cable duct for massive cable bundles
- ✓ Integral top cable ladders and cable trays in the front and rear
- ✓ 10-32 threaded front and rear rail
- ✓ Hook and loop fasteners and front cable feed-through hole plugs included for simplified cable management
- ✓ Includes 100 rack screws

| Part #      | Overall Height | Overall Depth | Mounting Channel Depth | Width | Racking Height | Recommended Power |
|-------------|----------------|---------------|------------------------|-------|----------------|-------------------|
| MK-19-45    | 84 1/4"        | 16 1/16"      | 6 3/8"                 | 24"   | 45 space       | N P R T           |
| MK-19-45-24 | 84 1/4"        | 24"           | 14"                    | 24"   | 45 space       | N P R T           |

• See pgs. 64-79 for complete list of power products. When mounting vertical power strips, part #PB-5A is required, see pg. 69.

GK-4G gland grommet. Hugs cables to reduce dust & control airflow within an enclosure, sold in packs of 4.

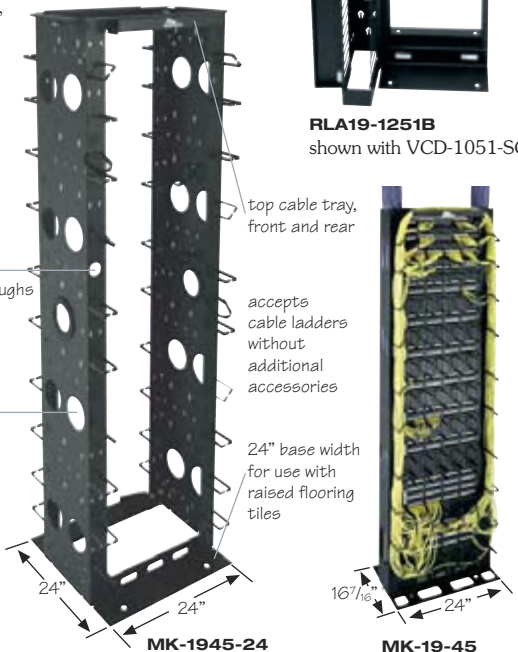
# Two Post Open Frame Racks And Options

**CK-45** center duct  
**CK-45E** end duct  
**CK-45C** split cover (2 pcs.)

**ACCEPTS ANT-SLIP CABLE PAD** see pg. 111

**ASP-OWP**

**ENHANCED**  
 cable tie posts for enhanced cable management

**TIA/EIA COMPLIANT**

## Dual Channel Organization System

The CK Series Cable Organizers are built with a dual channel design to handle extra large cable bundles while providing simple distribution provisions, front and rear. Designed to accommodate the R4CN, R412, RL10-45, RL12-45, RLA19-1251B and RLA19-1245B open frame racks, the CK Series measures 6" wide by 9" deep.

- ✓ Strategically placed tie posts and abundant front to rear cable openings for ease of use
- ✓ Center unit bolts between racks to facilitate front and rear cable exit
- ✓ End units facilitate left or right cable exit
- ✓ Split cover hides wires and cables and fits both center and end units

| Part # | Type             | Description   |
|--------|------------------|---|
| CK-45  | Center Organizer | center organizer, 45 space (84" overall) black finish                 |
| CK-45E | End Organizer    | end organizer, 45 space (84" overall) black finish                    |
| CK-45C | Organizer Cover  | cable organizer covers, 2 pieces, 45 space (84" overall) black finish |

### Dimensions

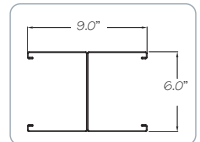

## Vertical Cable Chase With Door

Cable manager for RL, RLA and R4 Series 45 space open frame racks features abundant cable pass-throughs and tie posts. The solid front door with a 3 point magnetic latch is versatile enough to be installed to open in either direction. This versatile cable manager can also be mounted back to back for larger cable capacity.

| Part # | Description   |
|--------|---|
| RLA-CC | 45 space cable chase for 45 space R4, RL and RLA Series |

### Dimensions

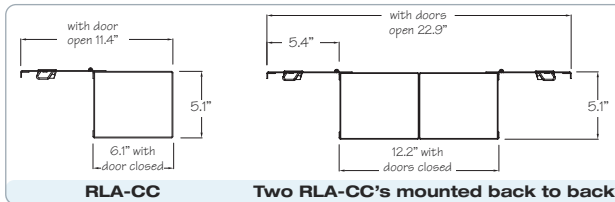

easy-to-assemble design

**RLA-CC** optional vertical cable manager features a full-length hinged access door

**ENHANCED**  
 cable tie posts for enhanced cable management

No need to fish in cable ties and straps - just slide them on!

15" deep base for stability

**RLA19-1245** shown with RLA-CC

## Vertical Cable Ducts With Finger Duct System

Protect cable bend radius and organize pathways for all data cables, patch cords and power cords between racks using our VCD Series vertical cable ducts. Designed for use with our RL, RLA and R4 open frame racks, these vertical cable ducts are available in single and dual (front and rear channel) duct versions. The VCD features a removable reversible door and is designed as a finger duct system to help protect cable bend radius.

| 10" Wide Part # | 6" Wide Part # | Description                 | Fits               |
|-----------------|----------------|-----------------------------|--------------------|
| VCD-10-51-DC    | VCD-6-51-DC    | dual cable duct, 51 space   | RLA, R4 Series     |
| VCD-10-51-SC    | VCD-6-51-SC    | single cable duct, 51 space | RLA, R4 Series     |
| VCD-10-45-DC    | VCD-6-45-DC    | dual cable duct, 45 space   | RL, RLA, R4 Series |
| VCD-10-45-SC    | VCD-6-45-SC    | single cable duct, 45 space | RL, RLA, R4 Series |
| -               | VCD-6-38-DC    | dual cable duct, 38 space   | RL, R4 Series      |
| -               | VCD-6-38-SC    | single cable duct, 38 space | RL, R4 Series      |

### Dimensions

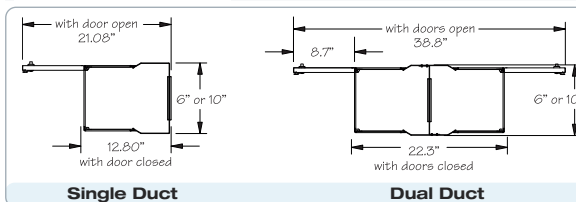

## Ladder Adapter

Ladder adapter for MK-19-45, RL and RLA Series racks accommodates most cable ladders. Includes mounting hardware and J-bolts.

| Part # | Description   |
|--------|---|
| MK-LA  | ladder adapter kit for MK-19-45 RL and RLA Series racks |

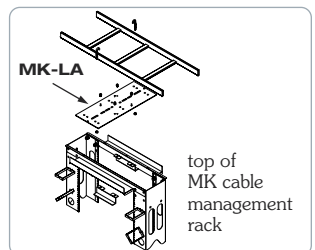

**VCD-10-51-DC**

fingers are strategically placed to facilitate cable management

**VCD-6-51-DC** shown with RLA



# Swing Frame And Swing Gate Wall Racks

## Swing Frame Rack

TIA/EIA COMPLIANT

A&E SPEC. # 96-984

Specify an SFR when mounting patch panels, hubs and switches in a secure room or closet. Innovative open-back wall mount design allows swing frame rack to be mounted over existing equipment and physical obstacles (conduit, telephone equipment, etc.)

- ✓ Open-back design maximizes useable wall space
- ✓ Rugged 100 lb. weight capacity, afforded by 14-gauge steel construction, provides the greatest strength in its class
- ✓ Unique, open swing frame design utilizes pivot points instead of hinges and can be inverted to allow opening from the left or the right
- ✓ 90° opening with positive stop facilitates punching down of wires while fully open and also minimizes stress on cable loops
- ✓ Ships ready-to-assemble to reduce space needed for storage and transport
- ✓ Abundant tie points and cable pass-throughs ease cable management
- ✓ Standard 11-gauge, 10-32 threaded rackrail with marked rackspace increments to speed equipment mounting
- ✓ Hook and loop cable fasteners provided for enhanced cable management
- ✓ Permanently lubricated bushings with a proprietary pivot prevent sag
- ✓ Black powder coat finish
- ✓ 50 rack screws included

| Part #               | Overall Height | Racking Height  | Depth | Weight Capacity |
|----------------------|----------------|-----------------|-------|-----------------|
| SFR-12-18            | 27¼"           | 21" (12 space)  | 18"   | 100 lbs.        |
| SFR-20-18            | 41¼"           | 35" (20 space)  | 18"   | 100 lbs.        |
| <b>NEW</b> SFR-25-18 | 50"            | 43¾" (25 space) | 18"   | 100 lbs.        |

## Swing Gate Rack

TIA/EIA COMPLIANT

A&E SPEC. # 96-207

Specify an SGR when mounting components such as hubs and patch panels. Open wall mount design is ideal for swinging equipment out to simplify wiring tasks and mounting components on crowded equipment walls.

- ✓ 100 lb. weight capacity when mounting on block or concrete wall or when using optional wall-strengthening mounting rails
- ✓ Swing gate design utilizes pivot points instead of side hinges and can be inverted to allow opening from the left or the right
- ✓ Permanently lubricated bushings with a proprietary pivot prevent sag
- ✓ Black textured powder coat finish
- ✓ 90° opening with positive stop facilitates punching down
- ✓ Ample tie points and hook and loop cable fasteners facilitate cable management
- ✓ Standard 11-gauge, 10-32 threaded rackrail with marked rackspace increments to speed equipment mounting
- ✓ Rack screws and hook and loop fasteners included

| Part #    | Overall Height | Racking Height | Depth | Weight Capacity |
|-----------|----------------|----------------|-------|-----------------|
| SGR-12-12 | 24½"           | 21" (12 space) | 12"   | 100 lbs.        |
| SGR-20-12 | 38½"           | 35" (20 space) | 12"   | 100 lbs.        |
| SGR-12-18 | 24½"           | 21" (12 space) | 18"   | 100 lbs.        |
| SGR-20-18 | 38½"           | 35" (20 space) | 18"   | 100 lbs.        |

### Optional Mounting Accessories

|        |   |
|--------|---|
| SGR-MR | wall strengthening mounting rails for use when mounting on non-concrete walls, includes mounting template |
|--------|---|

### Unique Feature

open back wall rack design mounts over existing conduit, telephone equipment, etc.

100 LB. WEIGHT CAPACITY, GUARANTEED NOT TO SAG WHEN MOUNTED CORRECTLY!

90° opening with positive stop to facilitate punch-down



SFR-12-18 shown in closed position

open position

**ENHANCED!**  
Now Ships Flat

rack screws included!

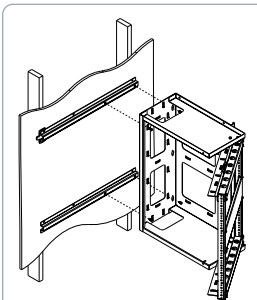

**SGR-MR**  
SGR-20-18 shown with optional SGR-MR wall strengthening mounting rails

**SGR-20-18**  
opens 90° with positive stop



# Pivoting Panel Mount And Hinged Panel Mount

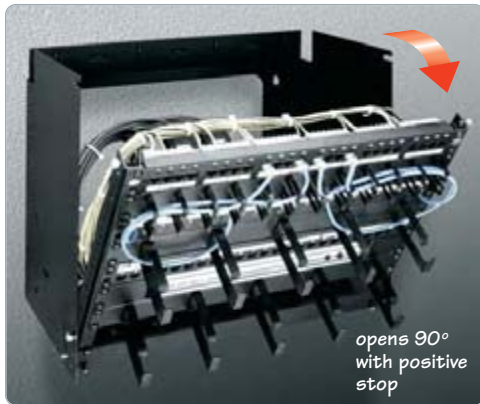

opens 90° with positive stop



**PPM-LID12**  
optional top cover/  
equipment shelf

**PPM-DO8**  
optional lift-off door

**PPM-8-12K**  
3 3/4" door-to-rail clearance (includes pivoting panel mount, top cover and door)

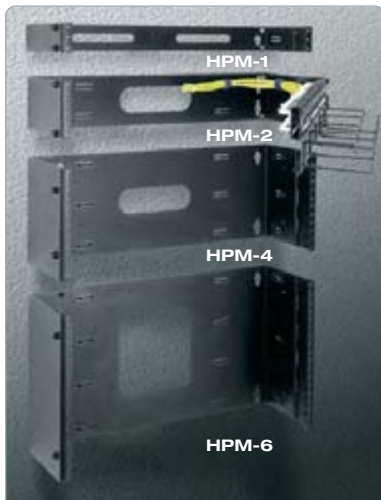

hinged panel mounts feature holes to allow mounting directly to rackrail of any open frame rack



**HPM-4** includes rear holes for rackmounting

## Pivoting Panel Mount

The logical choice for wall mounting patch panels and network equipment, pivoting panel mounts are offered in 6", 12", and 18" depths and provide easy rear access. Innovative design with 90° positive stop facilitates punching down while fully open. Featuring abundant tie points for cable management, hook and loop cable fasteners and rugged steel construction, each unit is finished in a durable black powder coat. The 8 space PPM-8-18 has a depth of 18" to accommodate deeper equipment. Rack screws and hook and loop fasteners included.

TIME/IA COMPLIANT  
A&E SPEC. # 96-210

| Part #   | Overall Height | Racking Height    | Depth | Weight Capacity |
|----------|----------------|-------------------|-------|-----------------|
| PPM-2    | 5 3/4"         | 3 1/2" (2 space)  | 6"    | 20 lbs.         |
| PPM-4    | 9 1/4"         | 7" (4 space)      | 6"    | 20 lbs.         |
| PPM-6    | 12 3/4"        | 10 1/2" (6 space) | 6"    | 30 lbs.         |
| PPM-6-12 | 12 3/4"        | 10 1/2" (6 space) | 12"   | 40 lbs.         |
| PPM-8-12 | 16 1/4"        | 14" (8 space)     | 12"   | 60 lbs.         |
| PPM-8-18 | 16 1/4"        | 14" (8 space)     | 18"   | 60 lbs.         |

## PPM Security Kits

Security kits completely enclose the PPM for installation in non-secure areas. Available for 12" and 18" deep models.

| Part #    | Includes                         |
|-----------|----------------------------------|
| PPM-6-12K | PPM-6-12 with top cover and door |
| PPM-8-12K | PPM-8-12 with top cover and door |
| PPM-8-18K | PPM-8-18 with top cover and door |

## PPM Security Options

Top covers and doors provide protection against dust and are available separately. Available for 12" and 18" deep models.

| Part #    | Includes                     |
|-----------|------------------------------|
| PPM-LID12 | top cover, fits 12" deep PPM |
| PPM-LID18 | top cover, fits 18" deep PPM |
| PPM-DO6*  | door, fits PPM-6-12          |
| PPM-DO8*  | door, fits PPM-8-12/PPM-8-18 |

\*When using door option, top cover is required

## Hinged Panel Mount

Our HPM Series provides simple and straightforward wall mounting of rackmount components and can also be rackmounted to any 19" open frame rack. Hinged to provide rear access to mounted components, each of the 1, 2, 4, and 6 space units are 6" deep. Features abundant tie points for internal cable management, hook and loop fasteners, a smooth cutout in rear for cable pull-through and heavy-duty threaded rackrail. Durable, attractive black powder coat finish, rack screws included.

TIME/IA COMPLIANT  
A&E SPEC. # 96-212

| Part #  | Racking Height                            |
|---------|---|
| HPM-1   | 1 3/4" (1 space)                          |
| HPM-2   | 3 1/2" (2 space)                          |
| HPM-4   | 7" (4 space)                              |
| HPM-6   | 10 1/2" (6 space)                         |
| HPM-LID | top dust cover acts as an equipment shelf |



**HPM-LID** top dust cover/ equipment shelf

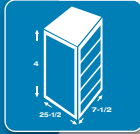

# HDR-4 Series Low-Profile Wall Mount Horizontal Equipment Cabinet

UL US LISTED  
TIME/FA COMPLIANT

A&E SPEC.  
# 96-975

Featuring an innovative, low-profile parallel-to-the-wall design, the Horizontal Distribution Cabinet is ideal for mounting patch panels with switches, hubs, routers and other equipment. Protruding only 7½” from the wall, the HDR provides 4 total rackspaces for equipment mounting in two sections.

### Structural Features

- ✓ Beveled front door with flanges on all sides provides greater security for equipment
- ✓ 150 lb. weight capacity
- ✓ Reversible hinged door with lock and padlockable latch allows opening from either side and provides additional security in open area installations
- ✓ Integral electrical box simplifies power distribution
- ✓ Constructed of 16-gauge steel, the HDR measures 24” wide by 36” high x 7½” deep
- ✓ Finished in a durable putty powder coat
- ✓ Standard 11-gauge, 10-32 threaded rackrail with marked rackspace increments to speed equipment mounting
- ✓ Pivoting rackrail speeds installation and servicing

### Thermal Management

- ✓ Ventilation slots on front cover address thermal management needs
- ✓ 4½” fan kit available, mounts externally to maximize equipment mounting and cable management space

### Cable Management

- ✓ Upper set of 2 space rackrail pivots 90° with a positive stop to simplify patch panel wire terminations
- ✓ Lower set of 2 space rackrail pivots for easy access to rear switch, hub and router connection points
- ✓ Cable management features include a 7” x 4” cable pass-through on backpan, abundant cable tie points and integral lacing bar on top set of rackrail
- ✓ 24” length of hook and loop fasteners included to facilitate cable management
- ✓ Laser knockouts on the top, bottom and sides for cable entry

### Code Compliancy

- ✓ Grounding/bonding stud in base of cabinet facilitates the proper grounding and bonding of electronic equipment, as per NEBS and NEC standards
- ✓ UL Listed in the US and Canada

| Part # | Racking Height                | Fan Kit                                       |
|--------|-------------------------------|---|
| HDR-4  | 3½” + 3½” (2 space + 2 space) | Part # Description                            |
|        |                               | HDR-FAN external 4½” fan kit and vent blocker |

### Easy Access To Equipment Connections

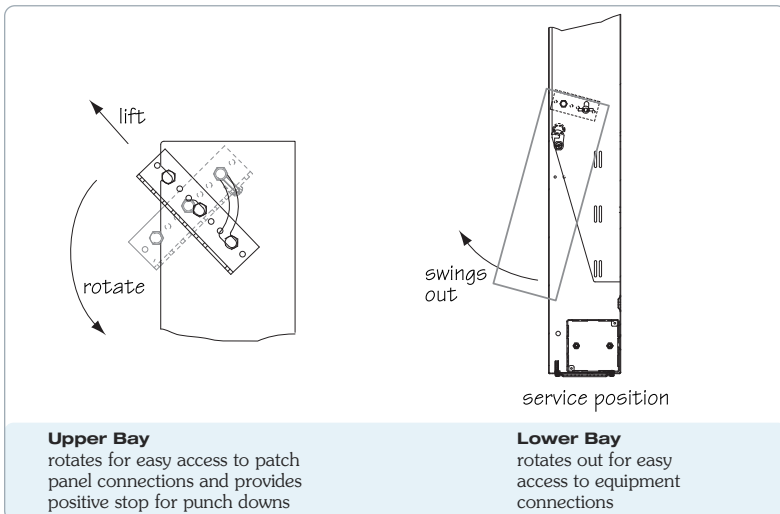

# Versa-Rack And Wall Mount Open Frame Rack



SPM-4 shown mounted on wall

## Versa-Rack Sideways Panel Mount

TIA/EIA COMPLIANT  
A&E SPEC. # 96-220

Mount hubs and other network components flat against the wall with this innovative all-steel sideways panel mount. Versa-Racks can also be used to mount components under tables and desks for commercial and classroom use. Cost effective in any application, each model features a single pair of high quality 11-gauge, 10-32 threaded rackrail that can be positioned in 3 locations to accommodate D-Ring cable managers (see pg. 113). The low-profile sideways panel mount is equipped with cable lacing points at the rear and includes a steel cover to protect and conceal equipment. Includes rack screws.

| Part # | Racking Height | Weight Capacity |
|--------|----------------|-----------------|
| SPM-2  | 3½" (2 space)  | 50 lbs.         |
| SPM-4  | 7" (4 space)   | 40 lbs.         |

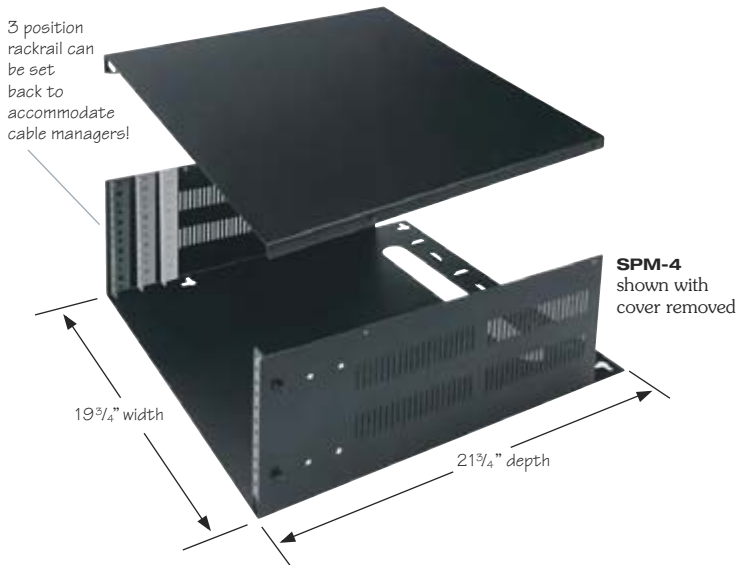

WM-15-18 shown with HCM-2D horizontal cable manager

fixed design prevents kinking or breaking of fiber-optics

## Wall Mount Open Frame Rack

TIA/EIA COMPLIANT  
A&E SPEC. # 96-291

A self-squaring rack for mounting virtually any data or telecommunications component, the Wall Mount Open Frame Rack is quick and easy to assemble thanks to its self-aligning design. The WM Series offers an effective method of wall mounting fiber-optic equipment as its fixed design prevents kinking or breaking of glass fibers. Rugged steel construction features 11-gauge, 10-32 threaded rackrail and a black textured powder coat finish. WM Series racks are offered in two depths (12" and 18"), with models in heights ranging from 17¾" to 56¼". Includes rack screws.

| Part #   | Overall Height | Racking Height  | Depth | Weight Capacity |
|----------|----------------|-----------------|-------|-----------------|
| WM-8-12  | 17¾"           | 14" (8 space)   | 12"   | 200 lbs.        |
| WM-15-12 | 30"            | 26¼" (15 space) | 12"   | 200 lbs.        |
| WM-30-12 | 56¼"           | 52½" (30 space) | 12"   | 175 lbs.        |
| WM-8-18  | 17¾"           | 14" (8 space)   | 18"   | 150 lbs.        |
| WM-15-18 | 30"            | 26¼" (15 space) | 18"   | 150 lbs.        |
| WM-30-18 | 56¼"           | 52½" (30 space) | 18"   | 125 lbs.        |



## The Definition of “Ground”

There are several interpretations of the term “ground,” which contributes to confusion and misunderstanding. Most commonly, ground refers to a return path for fault and leakage current. In electrical utility power, ground is an actual connection to soil for the primary purpose of lightning protection. Building safety grounds provide a return path specifically for fault current. The safety ground for audio, video, and other electronic systems must be designed to work in conjunction with the building (facility) safety ground.

**For optimal performance of AV equipment, all safety grounds for the electronic system should terminate at only one point.**

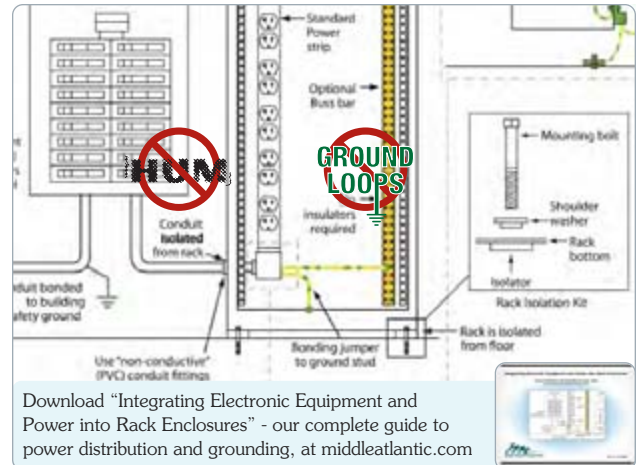

## Electrical Grounding

Electrical grounding is necessary to limit danger to the user from hazardous voltages due to lightning, some surges, and ground faults caused by equipment failure or conductor insulation failure. Proper electrical grounding assures safety by providing a low impedance path for “tripping” protective devices such as circuit breakers and fuses when a ground fault (short circuit to ground) occurs. This saves lives. **Defeating a safety ground to reduce noise is illegal, dangerous and should never be done!**

### Isolated Ground

An isolated ground is also referred to as a “technical ground” or “isolated single-point ground.” Equipment that is connected to an “isolated ground” system is still grounded, but the bonding point of the ground connection is **ONLY** at the main circuit breaker panel or at the first panel after a transformer. This isolated grounding conductor must be insulated. It may be spliced when passing through sub-panels or junction boxes, but must not be terminated in them.

### Ground Rods

Do not create multiple ground paths by using additional ground rods. Ground only where required by code for safety. Additional grounds may provide or create additional paths for ground loops and will most likely increase system noise. **Using more ground rods will NOT result in quieter systems.**

### Balanced Power

Differences in internal parasitic capacitances within connected equipment makes for a less effective balanced power system. Leakage currents from this capacitance is a significant cause of noise in unbalanced signal interfaces. **Balanced power is not a cost effective way to reduce system noise.** For reducing noise it is more cost effective to ground-isolate unbalanced signal interconnections, or eliminate them and use balanced signal interconnections which are inherently immune to the effects of leakage currents.

### Three Phase Electrical Service

Three Phase Electrical service is most commonly found in larger commercial and industrial buildings where there are motors, air conditioners and lighting controllers. Due to leakage current and grounded filter capacitors found in most equipment, loads on each phase usually couple a small amount of noise onto the ground circuit. Any device that draws a pulse of current for less than the entire voltage wave generates harmonics. Because the phase conductors are separated by 120°, some of the harmonic current in the neutral conductor is triplen. The additive currents are referred to as “triplen” harmonics.

### Split Single Phase Electrical Service

Split single phase electrical service is most commonly found in residences and smaller commercial buildings, and can be used to feed AV equipment. One key advantage that single phase has over three phase is that while harmonic currents are still present, it is not possible for the “triplen” components to add in the neutral. In addition, use of split single phase can result in at least a 6 dB reduction in the noise floor as compared to three phase if the capacitances of the connected equipment are relatively well balanced.

### Cable Management and Grounding Synergies

Proper grounding reduces only **ONE** potential source of noise. Good signal path design also requires adherence to cable management best practices, which includes the maintenance of a 2” separation between signal cables & untwisted AC power cables (when running parallel), and the twisting of signal conductors. If the conductors within the power cables are twisted tightly (see pg. 65) it is permissible to run signal cables within ½” of the power cables; if the respective conductors of both cable types are twisted tightly it is permissible, in specific cases, to strap signal conductors directly to power cables. Both the primary electrical system grounds and the signal interconnection system grounds need to be properly designed and installed to achieve a “noise free” system. Safety ground connections that are loose or corroded may cause hazardous conditions and system noise.

### “Hum & Buzz-Free”

“Hum & Buzz-Free” audio and “clean” video can **ONLY** be obtained by having a “noise-free” signal path. Signal path noise vulnerability depends on whether the signal interface is balanced or unbalanced. Design and installation of the signal path wiring must include noise interference rejection schemes and effective grounding. Useful information about signal path design can be found by doing an internet search of “electromagnetic induced noise,” “AES48,” “pin 1 problem” and “shield SCIN.”



# NEW Signal-Safe™ IEC Power Cords

## Signal-Safe™ IEC Power Cords



Signal-Safe™ IEC Power Cords replace the standard power cords provided with electronic components, and are available in multiple sizes, with standard or low-profile, 90° angled plugs. Here are three great reasons to insist on Signal-Safe™ for every job:

### Worry free installation

AC magnetic fields radiating from power cables are a leading cause of induced system hum. Signal-Safe™ IEC Power Cords are designed with the industry's tightest AC power cord conductor twist rate, resulting in the lowest level of radiated AC magnetic field strength.

The radiated AC magnetic field strength of Signal-Safe™ IEC Power Cords is five times less than that of standard power cords, and significantly less than loose wires in steel EMT Conduit. For the first time signal cables, which are highly sensitive to magnetically induced noise, can be conveniently cable-managed **with only a 1/2" separation from system power** with full confidence that signal integrity will be preserved.

### Minimize resistance, maximize power

Signal-Safe™ IEC Power Cords are manufactured with heavy 14-gauge conductors. This reduces the resistance along the length of the cable and, as compared to other power cords that use smaller gauge wire, provides for additional power at the load and a lower resistance safety ground return path for leakage currents.

### Save space and time

Don't waste valuable time & real estate in the back of the rack with the troublesome management of excessively long power cable loops. Signal-Safe™ IEC Power Cords are available in multiple lengths, providing a shorter path from component to power strip. This also further reduces AC magnetic field strength, and facilitates free circulation of cooling air within the rack.

| 6" Length Part # | 12" Length Part # | 18" Length Part # | 24" Length Part # | 36" Length Part # | 48" Length Part # | Plug Type              | Wire Gauge | Twisted | Qty |
|------------------|-------------------|-------------------|-------------------|-------------------|-------------------|------------------------|------------|---------|-----|
| IEC-6X4          | IEC-12X4          | IEC-18X4          | IEC-24X4          | IEC-36X4          | -                 | Straight               | 14 ga.     | yes     | 4   |
| IEC-6X20         | IEC-12X20         | IEC-18X20         | IEC-24X20         | IEC-36X20         | IEC-48X20         | Straight               | 14 ga.     | yes     | 20  |
| IEC-6X100        | IEC-12X100        | IEC-18X100        | IEC-24X100        | IEC-36X100        | IEC-48X100        | Straight               | 14 ga.     | yes     | 100 |
| IEC-6X20-90L     | IEC-12X20-90L     | IEC-18X20-90L     | IEC-24X20-90L     | IEC-36X20-90L     | IEC-48X20-90L     | Low-Profile Left Hand  | 14 ga.     | yes     | 20  |
| IEC-6X20-90R     | IEC-12X20-90R     | IEC-18X20-90R     | IEC-24X20-90R     | IEC-36X20-90R     | IEC-48X20-90R     | Low-Profile Right Hand | 14 ga.     | yes     | 20  |

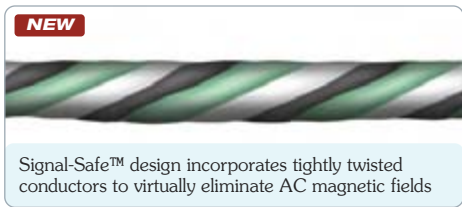

with the proper length power cords, cable management accessories are not needed!

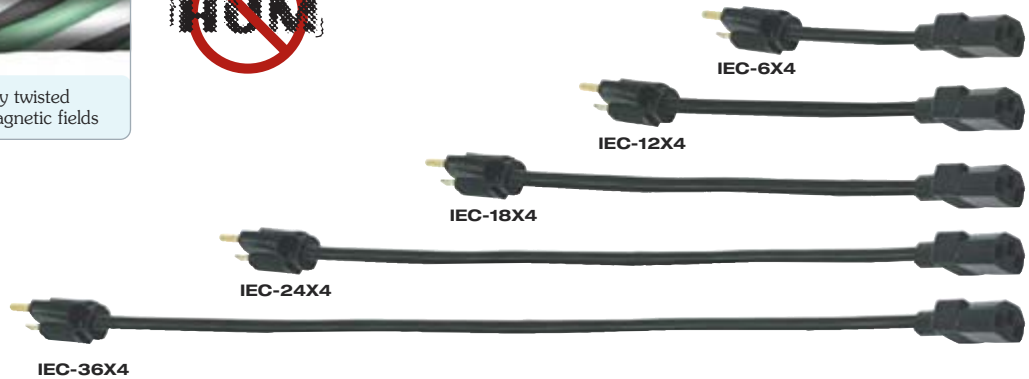

### The Benefit of Using the Correct Length IEC Power Cord

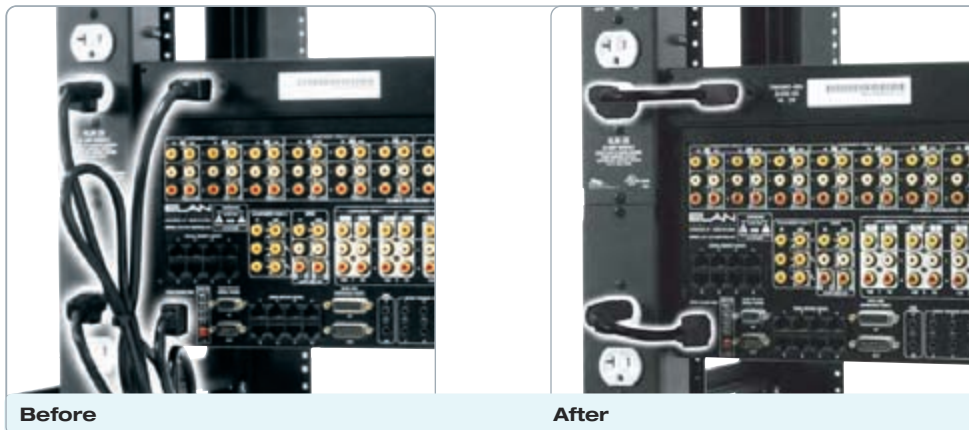

## PDT Series Thin Vertical Power Strips

### Choose The PDT Series For The Thinnest, Lightest, Most Configurable Vertical Power Strips

The complete selection of PDT Series Thin Power Strips consists of a range of pre-configured strips in two different lengths. In stock and ready to ship, the PDT Series strips feature multiple circuit, amperage and termination choices while occupying a minimal amount of space in the rack. These factory-assembled thin power strips with integrated J-Box are field configurable for isolated (technical) or non-isolated ground. All strips feature a lightweight aluminum chassis and a black anodized finish. UL Listed in the US and Canada.

Thin Power Strips Are In Stock With These Features:

- ✓ Small size uses a minimum of space
- ✓ 15 Amp models with J-Box are pre-wired with 12-gauge wiring and can be attached to a 20 Amp branch circuit
- ✓ Factory assembled for simplified ordering and installation
- ✓ Hardwired models can be field configured to operate as a single or dual circuit - **installer's choice!**
- ✓ Unique design on hardwired models allows for isolated (technical) ground configurability in the field - **installer's choice!**
- ✓ Saves time – ships fully assembled with all needed accessories
- ✓ Outlets spaced to provide enough room for plug-in power supplies
- ✓ Top feed models with J-box on the top of the power strips available to meet code requirements in select areas

PDT power strips come complete with **ENHANCED** mounting clips and have been engineered to attach to the rackrail brackets on all Middle Atlantic Products welded racks. Clips may also be attached to all of our wood racks as well as to walls and other surfaces by using appropriate fasteners.

### Installer's Choice - Field Configurable Power Strip

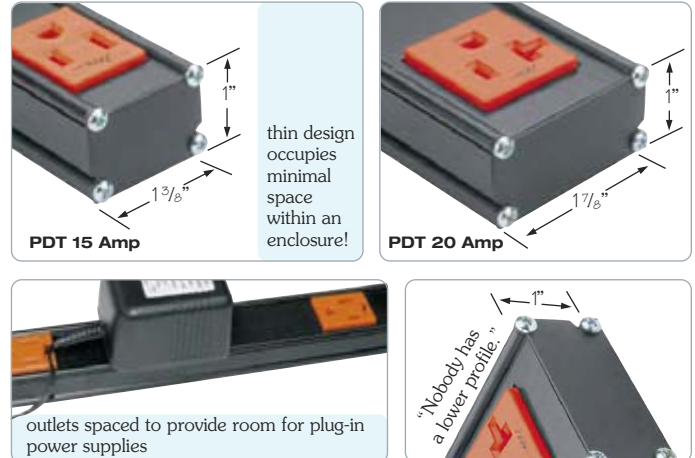
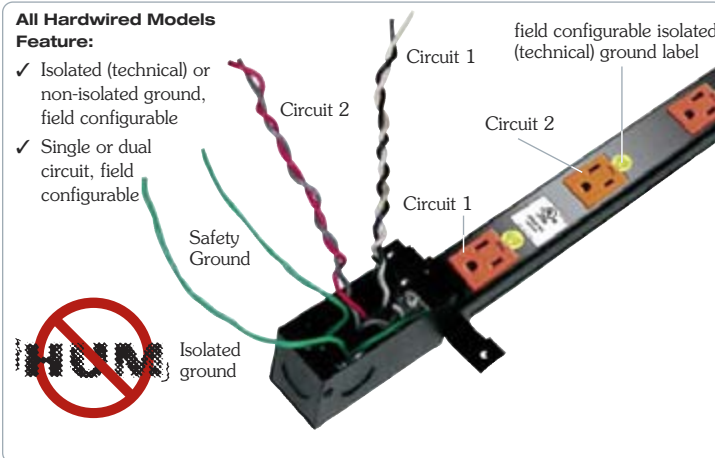

|                   | Fits Racks Coded | Part #         | Circuit                      | Termination                           | Protection      | # Of Outlets | Outlet Type | Overall Length | Isolated (Technical) Ground | UL Listed* |
|-------------------|------------------|----------------|------------------------------|---------------------------------------|-----------------|--------------|-------------|----------------|-----------------------------|------------|
| PDT SERIES 20 AMP | G                | PDT-1020C-NS   | 20 Amp (1)                   | 9' cord w/ NEMA 5-20P plug            | circuit breaker | 10           | 5-20R       | 37¾"           | no                          | 1          |
|                   | T                | PDT-2020C-NS   | 20 Amp (1)                   | 9' cord w/ NEMA 5-20P plug            | circuit breaker | 20           | 5-20R       | 72¾"           | no                          | 1          |
|                   | T                | PDT-2020TL-NS  | 20 Amp (1)                   | 9' cord w/ NEMA L5-20P twistlock plug | circuit breaker | 20           | 5-20R       | 72¾"           | no                          | 1          |
|                   | P                | PDT-2X1020     | 20 Amp (1 or 2 configurable) | J-BOX                                 | none            | 20           | 5-20R       | 72¾"           | field configurable          | 2          |
|                   | P                | PDT-2X1020T**  | 20 Amp (1 or 2 configurable) | J-BOX                                 | none            | 20           | 5-20R       | 72¾"           | field configurable          | 2          |
| PDT SERIES 15 AMP | G                | PDT-1015C-NS   | 15 Amp (1)                   | 9' cord w/ NEMA 5-15P plug            | circuit breaker | 10           | 5-15R       | 37¾"           | no                          | 1          |
|                   | NEW G            | PDT-1015C-NS20 | 15 Amp (1)                   | 20' cord w/ NEMA 5-15P plug           | circuit breaker | 20           | 5-15R       | 72¾"           | no                          | 1          |
|                   | T                | PDT-2015C-NS   | 15 Amp (1)                   | 9' cord w/ NEMA 5-15P plug            | circuit breaker | 20           | 5-15R       | 72¾"           | no                          | 1          |
|                   | P                | PDT-2X1015     | 15 Amp (1 or 2 configurable) | J-BOX                                 | none            | 20           | 5-15R       | 72¾"           | field configurable          | 2          |
|                   | P                | PDT-2X1015T**  | 15 Amp (1 or 2 configurable) | J-BOX                                 | none            | 20           | 5-15R       | 72¾"           | field configurable          | 2          |

\*UL Listings

1. UL Standard #1363, relocatable power taps (file # E194316)

2. UL Standard #5, multi-outlet assemblies (file # E174334)3. UL

\*\*J-Box located on top of strip

UL US LISTED  
A&E SPEC. # 96-01031

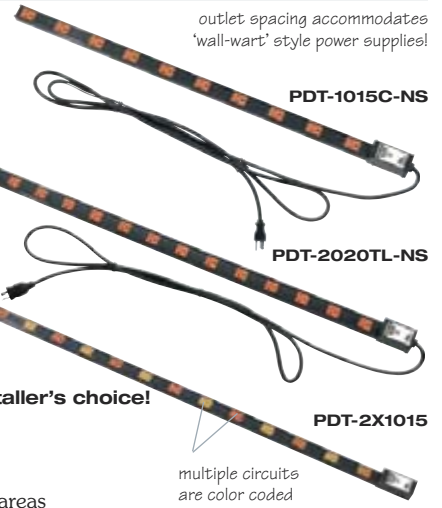

## PD Slim Series High Density Slim Power Strips Choose The PD Slim Series For Thin, High Density, Pre-Configured Power Strips

UL LISTED  
A&E SPEC. # 96-976

High density slim power strips, contain a number of outlets that have been spaced to accommodate plug-in power supplies, resulting in no wasted outlets! Measuring 1¼" deep by 1½" wide, these power strips provide maximum usability while taking up a minimum of space. Ships complete with 10' or **NEW** 20' power cord, terminated with a NEMA 5-15P or NEMA 5-20P plug, 15 Amp or 20 Amp circuit breaker and mounting system. UL and CSA Listed.

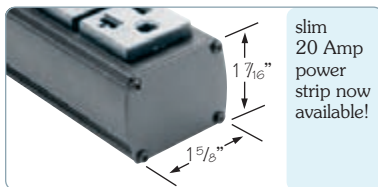

slim 20 Amp power strip now available!

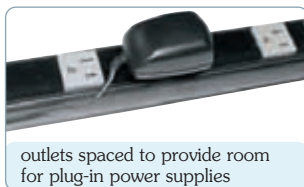

outlets spaced to provide room for plug-in power supplies



**PB-XS**  
rackmount power bracket for PD-815SC and PD-815SC-NS



**NEW**

**PD-815SC-PBSH**  
rear mount power option available for RSH Series custom rackshelves, RC and CAP Series rackshelves

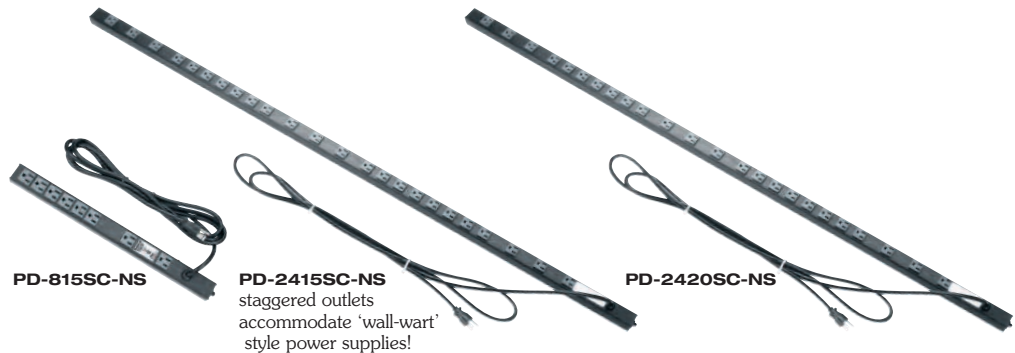

**PD-815SC-NS**

**PD-2415SC-NS**  
staggered outlets accommodate 'wall-wart' style power supplies!

**PD-2420SC-NS**

|                            | Fits Racks Coded                         | Part #                   | Circuit    | Termination                 | Protection                       | # Of Outlets | Outlet Type         | Overall Length |
|----------------------------|--|--------------------------|------------|-----------------------------|----------------------------------|--------------|---------------------|----------------|
| PD SLIM SERIES 15 & 20 AMP | N  | PD-2415SC-NS             | 15 Amp (1) | 10' cord w/ NEMA 5-15P plug | circuit breaker                  | 24           | 5-15R               | 60"            |
|                            | N  | PD-2415SC                | 15 Amp (1) | 10' cord w/ NEMA 5-15P plug | MOV surge + EMI filter + breaker | 24           | 5-15R               | 60"            |
|                            | N  | PD-2420SC-NS             | 20 Amp (1) | 10' cord w/ NEMA 5-20P plug | circuit breaker                  | 24           | 5-15R(22), 5-20R(2) | 60"            |
|                            | C  | PD-815SC-NS              | 15 Amp (1) | 10' cord w/ NEMA 5-15P plug | circuit breaker                  | 8            | 5-15R               | 18"            |
|                            | C  | PD-815SC                 | 15 Amp (1) | 10' cord w/ NEMA 5-15P plug | MOV surge + EMI filter + breaker | 8            | 5-15R               | 18"            |
|                            | C  | PD-815SC-20 <b>NEW</b>   | 15 Amp (1) | 20' cord w/ NEMA 5-15P plug | MOV surge + EMI filter + breaker | 8            | 5-15R               | 18"            |
|                            | rear of RSH, RC and CAP rackshelves only | PD-815SC-PBSH <b>NEW</b> | 15 Amp (1) | 10' cord w/ NEMA 5-15P plug | MOV surge + EMI filter + breaker | 8            | 5-15R               | 18"            |

UL Standard #1363, relocatable power taps (file # E128811)

## PD Series 30 Amp Vertical Power Strip

TIA/EIA COMPLIANT c UL US LISTED  
A&E SPEC. # 96-01067

The PD Series Dual Circuit 30 Amp Power Distribution strip provides two independent 15 Amp circuits. With 12 duplex receptacles (24 outlets) and a 9½' per cord, this power strip is ideal for:

- ✓ High current demand A/V racks
- ✓ High density server cabinets
- ✓ 30 Amp uninterruptible power supplies

This PD Series strip features dual circuit breakers with a lock-out pin to prevent accidental tripping of the breaker. UL Listed in the US & Canada.



two easily identifiable 15 Amp circuits

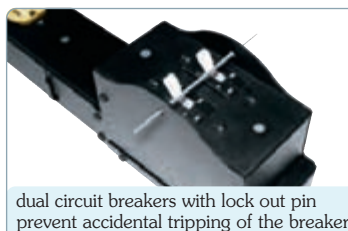

dual circuit breakers with lock out pin prevent accidental tripping of the breaker



**L5-30P**  
30 Amp plug



**PD-2X1215TL-30CB**

|                  | Fits Racks Coded | Part #           | Circuit    | Termination             | Protection      | # Of Outlets | Outlet Type | Overall Length |
|------------------|------------------|------------------|------------|-------------------------|-----------------|--------------|-------------|----------------|
| PD SERIES 30 AMP | N                | PD-2X1215TL-30CB | 15 Amp (2) | cord w/ NEMA L5-30 plug | circuit breaker | 24           | 5-15R       | 60"            |

UL Standard #1640, power distribution (file # E305595)

## PD Series Vertical Power Strips

### Choose The PD Series For The Widest Selection Of Pre-Configured Vertical Power Strips and Custom Configurations

The PD Series is a comprehensive vertical power strip line comprised of 17 pre-configured strips in four different sizes - all available and ready to ship from stock. Featuring multiple circuit, amperage, and termination choices, stock PD Series strips can satisfy many power requirements right off the shelf. All strips are constructed from 16-gauge steel, finished in a durable black powder coat and are UL Listed in the US and Canada.

Power Strips Are In Stock With:

- ✓ Both 15 and 20 Amp circuits
- ✓ Isolated (technical) ground circuits
- ✓ Single and dual circuits (with color-coded outlets for each circuit)
- ✓ Multiple MOV surge and spike protection (non-MOV strips available)
- ✓ Circuit breaker protection (non-protected strips are also available)
- ✓ Multiple termination choices: cord with plug, metal flex with tails, or J-box

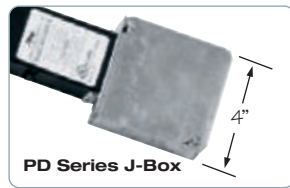
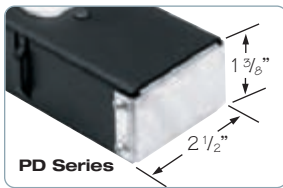

**MULTIPLE CIRCUITS OR DIFFERENT TERMINATIONS?**  
Please Call 800-266-7225

TIA/EIA COMPLIANT cUL US LISTED

A&E SPEC. # 96-938

|                  | Fits Racks Coded     | Part #               | Circuit                   | Termination                | Protection                       | # Of Outlets | Outlet Type | Overall Length | Isolated (Technical) Ground | UL Listed* |
|------------------|----------------------|----------------------|---------------------------|----------------------------|----------------------------------|--------------|-------------|----------------|-----------------------------|------------|
| PD SERIES 20 AMP | E                    | PD-620C-NS           | 20 Amp (1)                | 9' cord w/ NEMA 5-20P plug | circuit breaker                  | 6            | 5-20R       | 26½"           | no                          | 1          |
|                  | E                    | PD-620J-IG           | 20 Amp (1) ISO ground (1) | J-BOX                      | none                             | 6            | 5-20R       | 30½"           | yes                         | 3          |
|                  | J                    | PD-1020C-NS          | 20 Amp (1)                | 9' cord w/ NEMA 5-20P plug | circuit breaker                  | 10           | 5-20R       | 40"            | no                          | 1          |
|                  | J                    | PD-1020J-IG          | 20 Amp (1) ISO ground (1) | J-BOX                      | none                             | 10           | 5-20R       | 44"            | yes                         | 3          |
|                  | N                    | PD-1220C-NS          | 20 Amp (1)                | 9' cord w/ NEMA 5-20P plug | circuit breaker                  | 12           | 5-20R       | 57"            | no                          | 1          |
|                  | N                    | PD-1220J             | 20 Amp (1)                | J-BOX                      | none                             | 12           | 5-20R       | 61"            | no                          | 3          |
|                  | N                    | PD-1220J-IG          | 20 Amp (1) ISO ground (1) | J-BOX                      | none                             | 12           | 5-20R       | 61"            | yes                         | 3          |
|                  | N                    | PD-2X620J            | 20 Amp (2)                | J-BOX                      | none                             | 12           | 5-20R       | 61"            | no                          | 3          |
| N                | Call for information | 20 Amp (up to 6)     | flex or J-BOX             | none                       | up to 24                         | 5-20R        | up to 61"   | available      | 3                           |            |
| PD SERIES 15 AMP | E                    | PD-615C-NS           | 15 Amp (1)                | 9' cord w/ NEMA 5-15P plug | circuit breaker                  | 6            | 5-15R       | 26½"           | no                          | 1          |
|                  | E                    | PD-615C              | 15 Amp (1)                | 9' cord w/ NEMA 5-15P plug | MOV surge + EMI filter + breaker | 6            | 5-15R       | 26½"           | no                          | 1 & 2      |
|                  | E                    | PD-1215J-S           | 15 Amp (1)                | J-BOX                      | none                             | 12           | 5-15R       | 30½"           | no                          | 3          |
|                  | J                    | PD-1015C-NS          | 15 Amp (1)                | 9' cord w/ NEMA 5-15P plug | circuit breaker                  | 10           | 5-15R       | 40"            | no                          | 1          |
|                  | J                    | PD-1015C             | 15 Amp (1)                | 9' cord w/ NEMA 5-15P plug | MOV surge + EMI filter + breaker | 10           | 5-15R       | 40"            | no                          | 1 & 2      |
|                  | N                    | PD-1215              | 15 Amp (1)                | 3' flex w/ 8" tails        | none                             | 12           | 5-15R       | 57"            | no                          | 3          |
|                  | N                    | PD-2X615             | 15 Amp (2)                | 3' flex w/ 8" tails        | none                             | 12           | 5-15R       | 57"            | no                          | 3          |
|                  | N                    | PD-1415C-NS          | 15 Amp (1)                | 9' cord w/ NEMA 5-15P plug | circuit breaker                  | 14           | 5-15R       | 57"            | no                          | 1          |
|                  | N                    | PD-1415C             | 15 Amp (1)                | 9' cord w/ NEMA 5-15P plug | MOV surge + EMI filter + breaker | 14           | 5-15R       | 57"            | no                          | 1 & 2      |
|                  | N                    | Call for information | 15 Amp (up to 6)          | flex or J-BOX              | available                        | up to 24     | 5-15R       | up to 61"      | available                   | 3          |

\*UL Listings

1. UL Standard #1363, relocatable power taps (file #E194316) 2. UL Standard #1449, surge suppressors (file #E194316) 3. UL Standard #5, multi-outlet assemblies (file #E174334)

# Vertical Power Products

## Power Mounting Methods

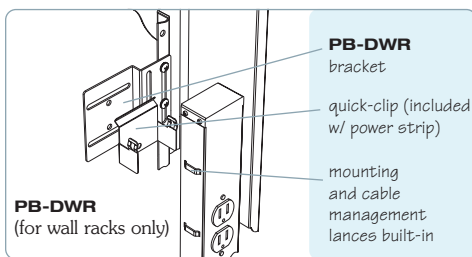
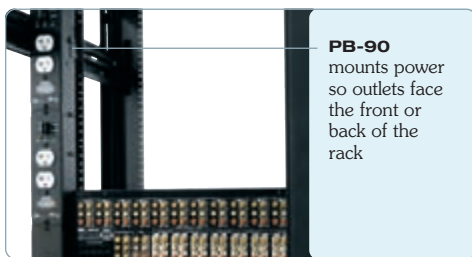
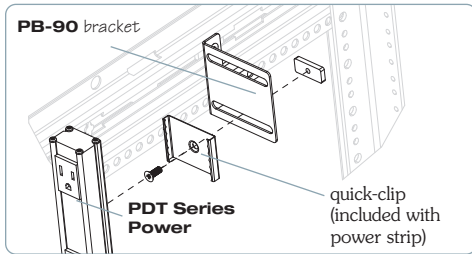
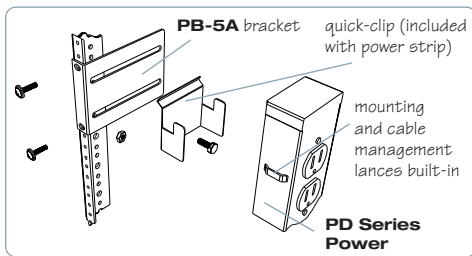

## PD Slim Series

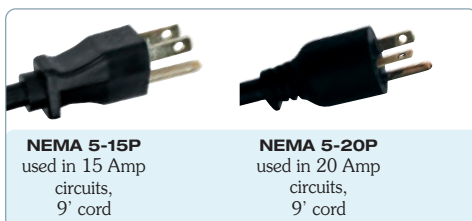

## Included Mounting System

All vertical power strips include a mounting system that provides fast and secure mounting. PD Slim Series strips include a quick-clip that when mounted into the rack, the power strip is hung in place via a series of mounting lances found along its sides. These lances also double as cable tie points, allowing AC cables to be neatly managed. PDT and PD Slim Series strips include a mounting clip that when installed in the rack, allows the strip to snap into place.

## Additional Mounting Brackets

PB-90 bracket orients power outlets on any vertical power strip to the front or back of the enclosure\*. Allows mounting of power strips alongside mounted equipment in wider WRK Series racks. Use PB-5A brackets to mount Middle Atlantic Products power strips in AXS, Slim 5, RL, RLA and MK Series racks, or to the rackrail of any rack. To mount power strips in the SR and DWR Series wall racks, use PB-DWR brackets. PB-XS rackmounting power bracket mounts any **C** power strip between rackrail of any rack, includes cable management tie points. Cable management clips available for PDT Series power strips, sold in packs of 6.

| Part # | Description  |
|--------|--|
| PB-90  | brackets mount vertical power to face front or back of any rack* (pair)      |
| PB-5A  | brackets to mount vertical power strips on rear rackrail (pair)              |
| PB-DWR | brackets to mount vertical power strips in DWR & SR Series wall racks (pair) |
| PB-XS  | bracket to horizontally rackmount <b>C</b> power strips                      |

\*requires LBFR-5A-xx to mount inside Slim 5 or AXS Series Racks

## Outlets

### PD Series

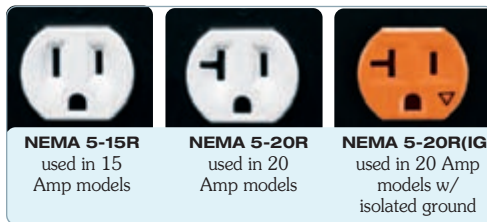

### PDT Series

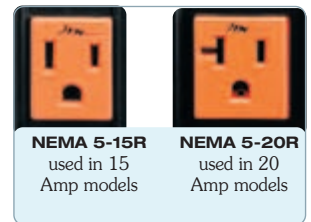

## Termination

### PD Series

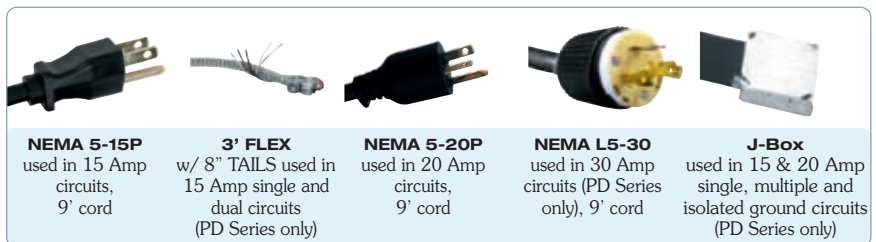

### PDT Series

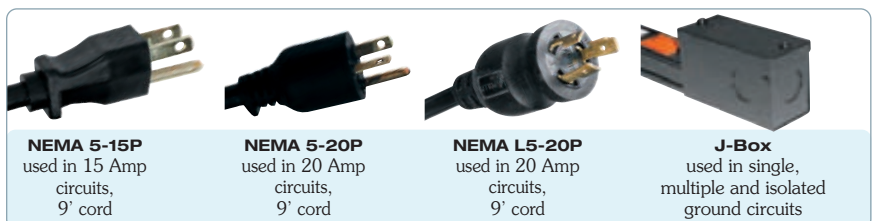

## Need A Custom Power Strip Fast? A Guide To The “Plug and Play” MPR System



Two problems can occur when a sound system requires power switching on and off on a regular basis: loud “pops” result from source or processing equipment that is turned on after power amplifiers, putting speakers at risk, or the circuit overloads from the in-rush current to power amplifiers. Solve these problems before they occur with the MPR Modular Power Raceway System.

Turning components on sequentially and using multiple circuits prevents these problematic situations. With an almost infinite number of configurations, the MPR System can incorporate multiple circuits and uses a controller with built-in sequencing logic to turn modules on one-by-one.

Works with most control systems!

### Application 1

**Multiple components require only one circuit, sequencing is required to ensure power amplifiers are always last on, first off**

- ✓ 6 MPR Power Modules
- ✓ 6 Sequenced Channels of Control
- ✓ 1 Circuit

#### Solution

A configured MPR System with a single circuit and 6 sequenced steps.

Due to the mix of source/processing equipment and power amplifiers, each module is powered on sequentially.

The USC-6R or MPR-SEQ Sequencing Controller or other control device enables this, avoiding the loud pops that occur when turning components on all at once.

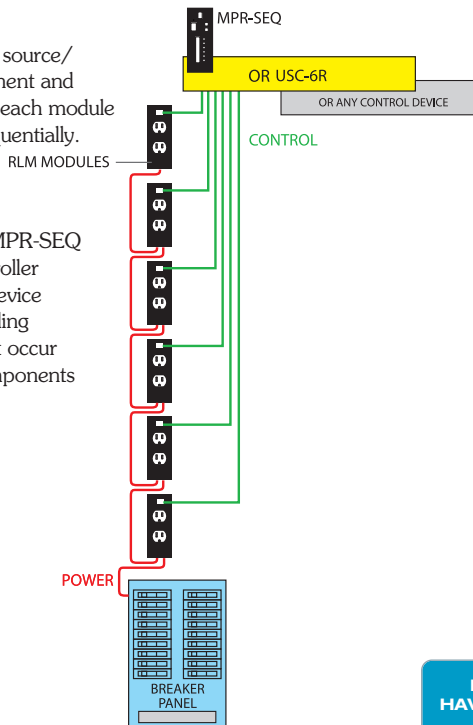

NEED HELP? HAVE QUESTIONS? Please Call!

### Application 2

**A rack houses larger power amplifiers plus source and processing equipment, requiring a single circuit with remote AC power control**

- ✓ 5 MPR Power Modules
- ✓ 1 MPR Sequencing Module
- ✓ 2 Sequenced Channels of Control
- ✓ 1 Circuit

#### Solution

One of the most common applications for the MPR System, this example provides two sequenced channels of control from the MPR-SEQ.

Additional M Series basic modules are connected and switched via a JMS Master/Slave Jumper that will slave them to the last module switched in the sequence.

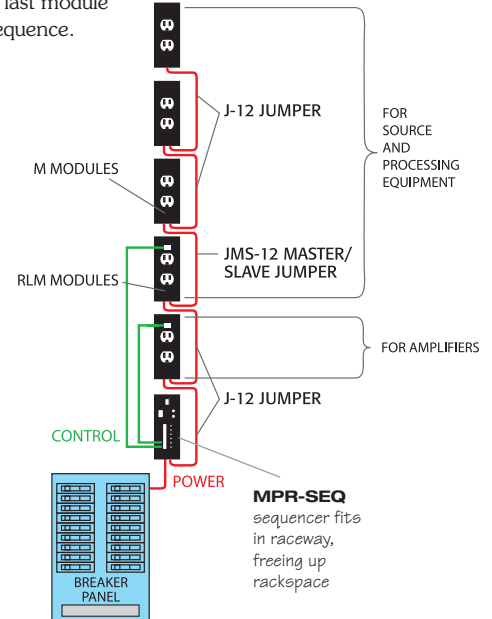

MPR-SEQ sequencer fits in raceway, freeing up rackspace

## Hot Tip! Economical Alternative To Application 1, Using PDS Series Sequencing Power Distribution

**Multiple components on a single circuit require sequencing due to the power amplifier’s in-rush current**

A PDS Series sequenced power distribution unit that provides six points of sequencing on one or two circuits, depending on model, with a standard 15 Amp power strip plugged into the first outlet is an economical alternative to the MPR system and will provide the same functionality. Connect the vertical power strip to first switched outlet for all source and processing equipment.

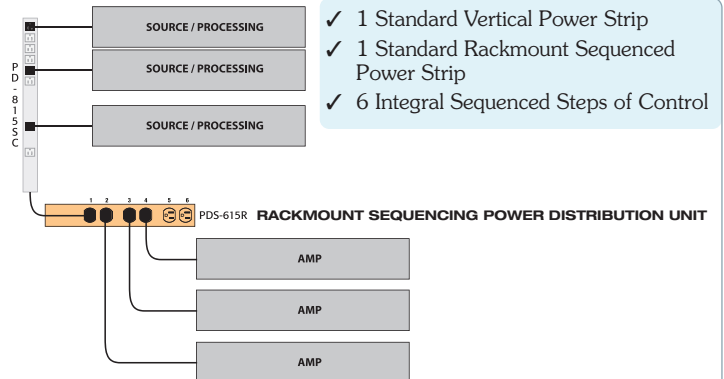

- ✓ 1 Standard Vertical Power Strip
- ✓ 1 Standard Rackmount Sequenced Power Strip
- ✓ 6 Integral Sequenced Steps of Control



# Modular Power Raceway Application Guide

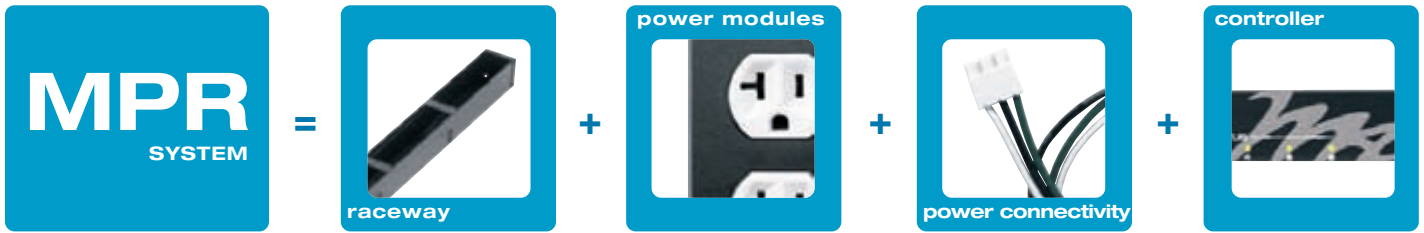

## Application 3 (Alternative To Application 2)

A rack houses larger power amplifiers plus source and processing equipment, requiring multiple circuits with remote AC power control

- ✓ 2 MPR Power Modules
- ✓ 1 MPR Sequencing Module
- ✓ 2 Sequenced Channels of Control
- ✓ 2 Circuits
- ✓ 1 Standard Vertical Power Strip

### Solution

While similar to Application 2, this solution uses a cost effective standard vertical power strip connected to the first switched outlet for all source and processing equipment.

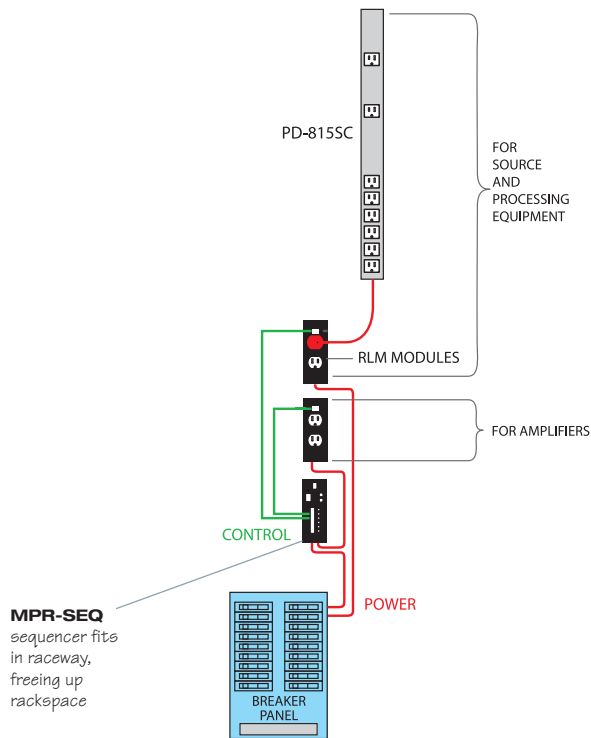

## Application 4

High current draw components require individual dedicated circuits and remote AC power control

- ✓ 13 MPR Power Modules
- ✓ 3 Channel of Control
- ✓ 13 Circuits

### Solution

An MPR system configured with 13 circuits and 3 channels of control. Generally this will be found in large applications where a bank of power amplifiers need to be powered on and off.

Because these are dedicated circuits, individual sequencing of amplifiers is not required.

With the MPR System, this solution can be created within 2 raceway chassis. 13 separate AC power tails connect to individual circuit breakers and a single connection to a customer supplied controller that facilitates power on and off.

This solution uses space in the rack efficiently and is UL Listed.

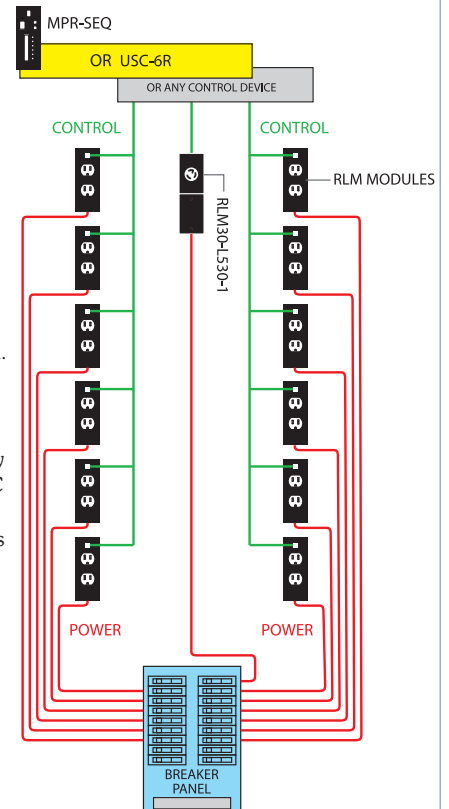

## Application 5

Equipment is in a remote location and requires local access for power control, i.e. self powered speakers

### Solution

When using a self powered speaker or other remotely located equipment, a stand-alone RLM Series MPR power module connected to any low voltage switch will allow switching of equipment from a different location.



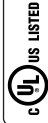

The MPR Series is comprised of power modules, raceways, interconnect cables and a sequencing controller if needed. Conveniently mix and match the power modules that are appropriate for each application. Specify and install with confidence – all components are UL Listed separately and as a system.

- Design It** - simply select the number of circuits and amperage/outlets required and choose the appropriate modules for the job. Decide whether to use our flexible rackmount sequencing controller, the USC-6R, or the space saving MPR-SEQ modular controller, or use any control system that provides contact closure outputs.
- Build It** - use pre-terminated interconnect system to connect modules in a fraction of the time (no hardwiring required!) and install the modules in the appropriate raceway.
- Easy Installation** - raceways install quickly into racks utilizing the unique “quick-clip” mounting method.

## How To Order

A configured MPR system consists of:

- ✓ **Raceway:** one MPR raceway chassis – accepts, 3, 6, 8 or 9 MPR modules
- ✓ **Power Modules:** MPR modules available in 15 Amp, 20 Amp, 20 Amp isolated ground and 30 Amp
- ✓ **Module Power Connectivity** – Jumpers: J Series AC jumpers interconnect same circuit modules
- ✓ **System Power Connectivity** – Tails: at least one T Series tail connects raceway circuit to main power
- ✓ **Sequencing Controller:** MPR-SEQ or USC-6R Universal Sequencing Controller, or other controller



Stand-Alone modules are also available

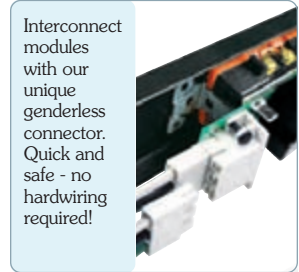

Interconnect modules with our unique genderless connector. Quick and safe - no hardwiring required!

## Raceway

The MPR raceway is the first component needed and is available in different sizes that accept 3, 6, 8 or 9 power modules.

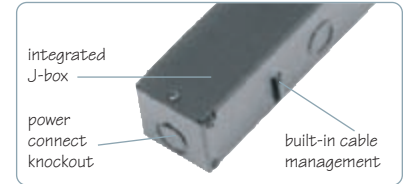
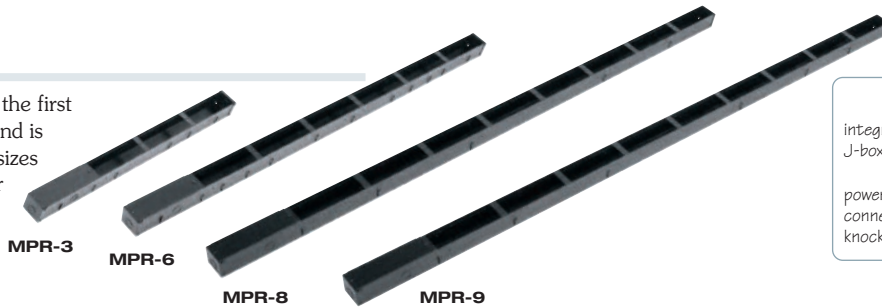

## Power Modules

Modules are available in 15 Amp, 20 Amp, 20 Amp isolated ground and 30 Amp modules. Stand-alone modules are also available. Determine which module is needed based on the amperage draw of the components being mounted and the level of control needed.

### RLM Series Advanced Modules

The RLM Series power module can be controlled remotely by contact closure and uses an oversized 240V 20 Amp relay for reliability. Units can also be powered on and off using the switch provided on the module. These modules additionally provide contact closure output for remote status as well as a local LED status display.

### M Series Basic Modules

The M Series power module is always on when connected to constant power and does not provide status indication. Dual duplex modules are available with installers' choice of 1 or 2 circuits (field configurable).

**HOT TIP!** The M module can be switched inexpensively via the RLM modules when connected with a JMS Series master/slave jumper.



RLM-20 advanced module



M-15 basic module



M-30TL-HW basic hardwired module



M-2X20IG dual duplex basic module

### M Series 30 Amp Hardwired Module

The M-30TL-HW 30 Amp, hardwired always on module mounts in any MPR raceway. This basic, hardwired module will allow addition of a single unswitched outlet, 30 Amp circuit to any MPR system (NEMA L5-30R outlet). Must be field wired.

### 30 Amp Hardwired Stand-Alone Modules

30 Amp stand alone power modules provide switchable power distribution for components requiring 30 Amp power. These modules can be controlled locally or remotely by using Middle Atlantic Products' Universal Sequencing Controller, model # USC-6R or by any controller that sends 12 volt DC or contact closure outputs.



RLM30-L530-1

Compatible with most control systems!



RLM30-L530-1





# Modular Power Raceway System Ordering Guide

## Power Connectivity



**J-12X6**  
jumper

**T-80X6**  
tails

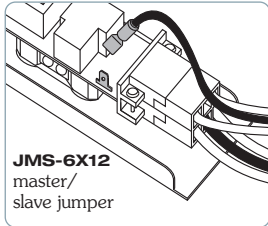

**JMS-6X12**  
master/  
slave jumper

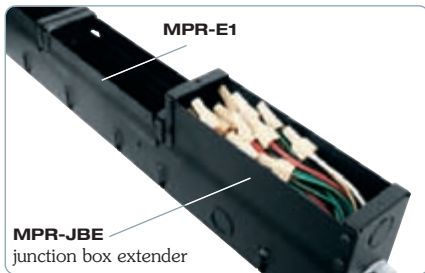

**MPR-E1**

**MPR-JBE**  
junction box extender

### J Series Jumpers

J Series jumpers interconnect power modules, providing AC power to all modules on the same circuit. Pre-terminated jumpers feature convenient genderless connectors at both ends. Sold in packs of 6.

### T Series Tails

T Series tails connect incoming power to a single circuit within a raceway. One tail required per circuit. Each tail features a pre-terminated connector that plugs into a module at one end, and wire tails for J-Box connection on the other. Sold in packs of 6.

### JMS Master/Slave Jumper

Economical M Series basic modules can be controlled by advanced RLM Series modules on the same circuit, utilizing the JMS master/slave jumper. Sold in packs of 6.

### Raceway Extensions

The raceway extensions increase the cubic volume of the raceway for field connection terminations to accommodate large amounts of circuits. The MPR-E1 is ideal for use anywhere on the raceway, and the MPR-JBE J-Box extender is optimized for use on the J-Box.



**MPR-E1**



**MPR-JBE**

## Control



### Sequencing Module

The MPR-SEQ sequencing module provides economical 6-step sequencing control to RLM Series advanced modules. Its unique design allows for mounting within an MPR raceway, freeing up rackspace in high-density installations. The sequencer uses a relay contact closure to switch RLM modules and allows for control of up to 30 modules evenly distributed among the contacts. Sequencing can be initiated locally via the convenient front panel switch, as well as remotely using the Middle Atlantic Products wall plate or Decora® mount switch (see below), or via any momentary contact closure switch (single pole, double throw, center off). Also available as a stand-alone module.

### Rackmount Sequencing Controller

The USC-6R Universal Sequencing Controller provides 6-step sequencing control to any system that can be controlled by 12 VDC or dry contact closure. Sequencing can be initiated locally via the convenient front panel switch, as well as remotely via wall plate switch (see below) or any momentary contact closure switch (single pole, double throw, center off). Featuring an interval delay selector of 1, 3 or 6 seconds between sequence steps, the unit additionally provides four different start delay settings, allowing up to three USC-6R units to be interconnected to operate as a single 18-step unit. Occupying one rackspace, the USC-6R front panel includes individual channel LED status indicators, as well as master power, local sequence initiation and interval delay controls. Each USC-6R can control an unlimited number of RLM Series advanced modules.



**MPR-SEQ**

### USC-6R



front

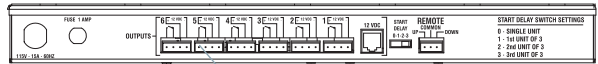

rear

removable terminal blocks allow for prewiring on the jobsite

### Remote Switch

USC-KL or USC-SWL key or switch wall plate provides remote up/down sequence initiation. Provided status LED indicators connect to our USC-6R Universal Sequencing Controller via the convenient RJ-45 jack and terminal block. Use the USC-K, USC-SW, K-DEC or S-DEC with the MPR-SEQ sequencing module.



**USC-SWL**

**USC-KL**

**USC-SW**

**USC-K**



**K-DEC\***

**S-DEC\***

\*mounts ONLY in Middle Atlantic Products Decora® openings (panels and racks), also for use with PDS Series sequencers

also for use with PDS Series sequencers

# Modular Power Raceway System Ordering Guide

## Raceways

Available in four sizes to accommodate 3, 6, 8 or 9 power modules, modular raceways provide a rugged housing that allows the user to configure the right power distribution system for the application. Constructed of 18-gauge steel, each raceway features electrical knockouts for cable entry, an integral J-Box with removable cover and abundant cable lacing points along both sides.

| Part # | # of Power Modules Accommodated | Overall Length | Fits Racks Coded |
|--------|---------------------------------|----------------|------------------|
| MPR-3  | 3                               | 32"            | <b>E</b>         |
| MPR-6  | 6                               | 56"            | <b>N</b>         |
| MPR-8  | 8                               | 72"            | <b>R</b>         |
| MPR-9  | 9                               | 80"            | <b>V</b>         |

UL Standard #5 multi-outlet assemblies  
UL File # E174334

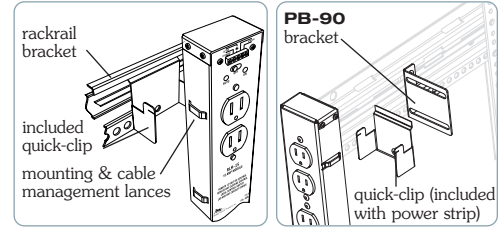

mounts power so outlets face the front or back of the rack, see pg. 69 for the PB-90

## Blank Covers

| Part # | Description   |
|--------|---|
| MPR-BL | blank cover for MPR raceways to close any unused module opening, sold in packs of 6 |

Raceways accommodate FC-4 Proportional Speed Thermostatic Fan Control, see below.

## Raceway Extensions

The raceway extensions increase the cubic volume of the raceway for field connection terminations to accommodate large amounts of circuits. The MPR-E1 is ideal for use anywhere on the raceway, and the MPR-JBE J-Box extender is optimized for use on the J-Box.

| Part #  | Description      |
|---------|------------------|
| MPR-E1  | module extension |
| MPR-JBE | J-Box extension  |

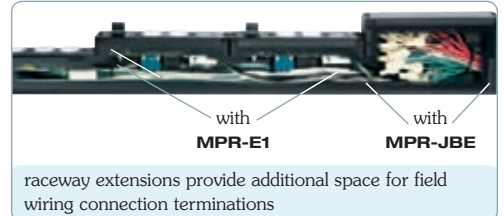
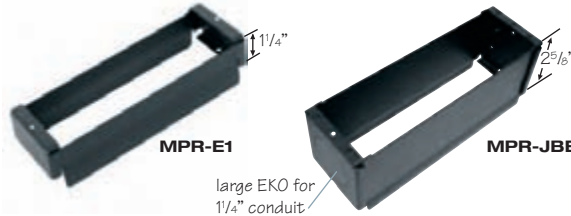

## Power Modules

All modules utilize a unique genderless connector to daisy-chain AC power to other modules on the same circuit. Modules fit any MPR Series raceway, are manufactured from 18-gauge steel and feature a durable black powder coat finish. Stand-alone modules, feature built-in cable management, mount in rack or on any surface and come complete with 9' power cord.

| Module Type                | Module Part # | Stand-Alone Part # | Amperage                                  | Control                              | Status                |
|----------------------------|---------------|--------------------|---|--------------------------------------|-----------------------|
| RLM Series Advanced Module | RLM-15        | RLM-15-1C          | 15  | contact closure, local switch        | LED & contact closure |
|                            | RLM-20        | RLM-20-1C          | 20  | contact closure, local switch        | LED & contact closure |
|                            | RLM-20IG      |                    | 20/isolated ground                        | contact closure, local switch        | LED & contact closure |
|                            |               | RLM30-L530-1       | 30  | contact closure, local switch        | LED & contact closure |
|                            |               | RLM30-L520-1       | 30  | contact closure, local switch, 12VDC | LED & contact closure |
| M Series Basic Module      | M-15          |                    | 15  | none                                 | none                  |
|                            | M-2X15        |                    | 15 dual or single circuit                 | none                                 | none                  |
|                            | M-20          |                    | 20  | none                                 | none                  |
|                            | M-2X20        |                    | 20 dual or single circuit                 | none                                 | none                  |
|                            | M-20IG        |                    | 20/isolated ground                        | none                                 | none                  |
|                            | M-2X20IG      |                    | 20/isolated ground dual or single circuit | none                                 | none                  |
|                            | M-30TL-HW     |                    | 30  | none                                 | none                  |



## Fan Control Modules

Fan Control modules feature proportional speed thermostatic control, user definable temperature range and control for up to four fans. See pg. 84 for more information. The FC-2-215-1C stand-alone module controls up to two fans and includes two always on 15 Amp outlets.

| Module Part # | Stand-Alone Part # | Description   | Amperage  | Control                    | Status |
|---------------|--------------------|---|---|----------------------------|--------|
| FC-4          | FC-4-1C            | Fan control (controls 4 fans)                       | 1.5 Amp   | local switch/temp. control | LED    |
| -             | FC-2-215-1C        | Fan control (controls 2 fans) w/ two 15 Amp outlets | 15 Amp (power and fan combined, fans 1.5 Amp max) | local switch/temp. control | LED    |

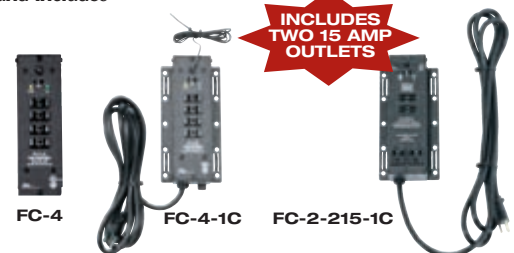

A&E SPEC. # 96-959



A&E SPEC. # 96-959

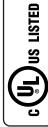

A&E SPEC. # 96-959



A&E SPEC. # 96-980

# MPR Raceway System



J-12X6

T-80X6

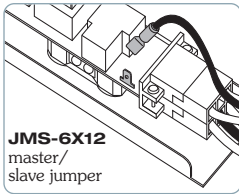

JMS-6X12  
master/  
slave jumper



## Module Connection Jumpers and Tails

JMS Series master/slave jumpers allow economical M Series modules to be switched remotely by an RLM Series module. Jumpers & tails are available in multiple lengths to accommodate any application, and use robust 30 Amp 'appliance grade' connectors.

| Part #   | Jumper Length | Termination  | Quantity           |
|----------|---------------|--|--------------------|
| J-12X6   | 12"           | connector on each end  | sold in packs of 6 |
| J-24X6   | 24"           | connector on each end  | sold in packs of 6 |
| J-72X6   | 72"           | connector on each end  | sold in packs of 6 |
| T-24X6   | 24"           | connector on one end, tails on the other                           | sold in packs of 6 |
| T-80X6   | 80"           | connector on one end, tails on the other                           | sold in packs of 6 |
| JMS-12X6 | 12"           | connector on one end, connector plus push-on terminal on the other | sold in packs of 6 |

## Sequencing Controller

Six-step sequencing provided by rackmount USC-6R sequencer, raceway mount MPR-SEQ or stand-alone MPR-SEQ-1C. Provides sequencing to any AC power distribution system that can be controlled by low voltage switch closure. Sequencing may be initiated locally via convenient front panel switch or by any momentary contact closure switch (single pole, double throw, center off). Remote switches are also available. The single rackspace USC-6R rackmount sequencer additionally features an interval delay selector of 1, 3 or 6 seconds between steps and four different start delay settings to allow up to three USC-6R units to be interconnected to operate as a single, 18-step unit.

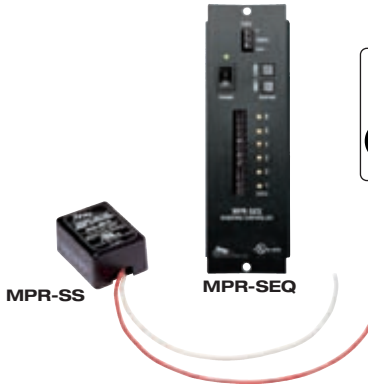

MPR-SS

MPR-SEQ



| Part #     | Description                     | Steps                    | Remote Control Options |
|------------|---------------------------------|--------------------------|------------------------|
| MPR-SEQ    | raceway mount controller        | 6 individually sequenced | contact closure        |
| MPR-SEQ-1C | stand-alone controller          | 6 individually sequenced | contact closure        |
| USC-6R     | rackmount sequencing controller | 6 individually sequenced | contact closure        |

UL Standard #: 1419 UL File #: E204950

## Surge Suppression

MPR-SS transient voltage surge suppressor provides protection for MPR Series modules when mounted in raceways. Mount up to two in integral J-Box with supplied double-stick tape, use one per circuit.

| Part # | Description                          |
|--------|--------------------------------------|
| MPR-SS | MPR surge suppressor, single circuit |



G-8X10



USC-SWL

USC-KL



USC-SW

USC-K

## G-8X10 Ground Wires

Set of ten 8" ground wires with termination rings simplifies attachment of multiple ground wires to a supplemental grounding stud.

| Part # | Description         |
|--------|---------------------|
| G-8X10 | ten 8" ground wires |

## Remote Switch

A remote switch or key that provides remote up/down sequence initiation. Status LED indicators are also provided on some switches; and connect to our USC-6R Universal Sequencing Controller via a convenient RJ-45 jack and terminal block. Decora® mount switches mount only to Middle Atlantic Products Decora® openings (panels and racks).

| Part #  | Description  | Controls                        |
|---------|--|---------------------------------|
| USC-SWL | remote wall plate switch with LED status indicators    | USC-6R                          |
| USC-KL  | remote wall plate keyswitch with LED status indicators | USC-6R                          |
| USC-SW  | remote wall plate keyswitch (no LEDs)                  | MPR-SEQ, MPR-SEQ-1C, PDS Series |
| USC-K   | remote wall plate switch (no LEDs)                     | MPR-SEQ, MPR-SEQ-1C, PDS Series |
| K-DEC*  | remote Decora® mount keyswitch (no LEDs)               | MPR-SEQ, MPR-SEQ-1C, PDS Series |
| S-DEC*  | remote Decora® mount switch (no LEDs)                  | MPR-SEQ, MPR-SEQ-1C, PDS Series |
| USC-KEY | additional set of keys for USC-KL or K-DEC             | -                               |

\*mounts ONLY in Middle Atlantic Products Decora® openings (panels and racks)



K-DEC

S-DEC

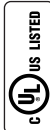

## Pre-Configured MPR Series Power Distribution

Designed to save installation time, the PCR Series factory-assembled raceways utilize six power modules. These twelve outlet vertical strips connect to one or two 20 Amp circuits\* and feed six 20 Amp duplexes (12 outlets). Each duplex can be independently controlled with the USC-6R Universal Sequencing Controller, or with any other sequencing controller that provides switch enclosure output. The PCR Series pre-configured raceways are 56" long, terminate in an integral junction box, are manufactured using 18-gauge steel and feature a durable black powder coat finish.

| Part #    | Circuit*   | Termination | Overall Length | Fits Racks Coded |
|-----------|------------|-------------|----------------|------------------|
| PCR6      | 20 Amp (1) | J-Box       | 56"            | N                |
| PCR-2X320 | 20 Amp (2) | J-Box       | 56"            | N                |

\*capable of up to 6 circuits when used with additional T Series tails

PCR-2X320

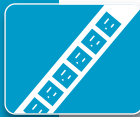

# Rackmount Power and Lighting

## Choosing The Correct Rackmount Power Distribution

Different systems have different requirements when it comes to power distribution. Middle Atlantic Products' suite of robust and flexible power products allow you to choose the power distribution product that is the perfect fit for each application.

### Surge Suppression

All power distribution products with surge suppression utilize a clean line-to-neutral design that **does not pass noise contaminaton to ground.**

### 2 Stage Surge Suppression

Available on select rackmount power distribution units, provides multiple levels of suppression and local notification of the protection level, as well as remote notification when protection has been compromised.



| Stage 1 Indicator | Stage 2 Indicator | Status                             |
|-------------------|-------------------|------------------------------------|
| On                | On                | Full Protection                    |
| Off               | On                | Stage 1 Compromised Stage 2 Active |
| Off               | Off               | Load Unprotected                   |

### Monitoring **NEW**

The new PD-915R-M power distribution unit monitors 8 important parameters: voltage, current, watts, VA, frequency, power factor, KWh and run time.



### Outlet Orientation

The orientation of the outlets is critical depending on the type of power supplies being plugged into the power distribution unit. There are two different orientations available: Vertical and Horizontal. A vertical orientation features outlets that are optimized for use with plug in power supplies.

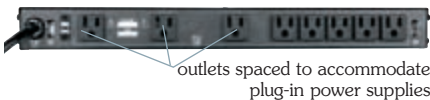

outlets in a vertical orientation

outlets spaced to accommodate plug-in power supplies



outlets in a horizontal orientation

### Front Power Switch

A power switch on the front of the power distribution unit allows the power to be turned on and off easily. Units without a front power switch provide more security.



with a front mounted power switch



without a front mounted power switch

### Retractable Light; USB Light

Select power distribution units feature a retractable LED light that provides evenly distributed illumination for component viewing. Some units additionally accept the optional USB LED worklight for lighting the rack interior to facilitate wiring.



### Cord Length

Most power distribution units are supplied with a 9' power cord. Select models are offered with a new 20' power cord, which eliminates the need for an extension cord.

### Sequencing

Power units that feature sequencing allow you to control the order the equipment is powered on. This reduces the possibility of circuit overload due to excessive in-rush current. Additionally, powering on amplifiers after source or processing equipment protects speakers from damage.



### Finish

Powdercoat finishes are ideal for most installations; when aesthetics are important select a black or silver anodized finish.



powdercoat finish



anodized finishes



# Rackmount Power and Lighting Selection Guide



|                      | Part #        | Circuit(s) | Front Outlet(s) | Rear Outlets | Finish                    | Surge & Spike | Monitoring/ Sequencing | Front Power Switch | Retractable Light | LED Light Option | Outlet Orientation | Cord Length | Chassis Depth |
|----------------------|---------------|------------|-----------------|--------------|---------------------------|---------------|------------------------|--------------------|-------------------|------------------|--------------------|-------------|---------------|
| A&E SPEC. # 96-01044 | PD-915RV-RN   | one 15 Amp | 1               | 8            | black powder coat         | yes - 2 stage | —                      | yes                | —                 | front & rear     | vertical           | 9'          | 9"            |
| A&E SPEC. # 96-01044 | PDLT-815RV-RN | one 15 Amp | —               | 8            | black powder coat         | yes - 2 stage | —                      | yes                | yes               | rear             | vertical           | 9'          | 13½"          |
| A&E SPEC. # 96-939   | PD-915R       | one 15 Amp | 1               | 8            | black powder coat         | yes           | —                      | yes                | —                 | —                | horizontal         | 9'          | 9"            |
| A&E SPEC. # 96-939   | PD-915RC-20   | one 15 Amp | 1               | 8            | black powder coat         | yes           | —                      | yes                | —                 | —                | horizontal         | 20'         | 9"            |
| A&E SPEC. # 96-01092 | PD-915R-M     | one 15 Amp | 1               | 8            | black powder coat         | yes           | monitoring             | yes                | —                 | —                | horizontal         | 9'          | 9"            |
| A&E SPEC. # 96-939   | PD-920R       | one 20 Amp | 1               | 8            | black powder coat         | yes           | —                      | yes                | —                 | —                | horizontal         | 9'          | 9"            |
| A&E SPEC. # 96-939   | PD-920RC-20   | one 20 Amp | 1               | 8            | black powder coat         | yes           | —                      | yes                | —                 | —                | horizontal         | 20'         | 9"            |
| A&E SPEC. # 96-939   | PD-920R-NS    | one 20 Amp | 1               | 8            | black powder coat         | —             | —                      | yes                | —                 | —                | horizontal         | 9'          | 9"            |
| A&E SPEC. # 96-01044 | PDLT-815RVA   | one 15 Amp | —               | 8            | black brushed & anodized  | yes           | —                      | —                  | yes               | rear             | vertical           | 9'          | 13½"          |
| A&E SPEC. # 96-01044 | PDLT-815RVC   | one 15 Amp | —               | 8            | silver brushed & anodized | yes           | —                      | —                  | yes               | rear             | vertical           | 9'          | 13½"          |
| A&E SPEC. # 96-939   | PD-815RA-PL   | one 15 Amp | —               | 8            | black brushed & anodized  | yes           | —                      | —                  | —                 | —                | horizontal         | 9'          | 13½"          |
| A&E SPEC. # 96-939   | PD-815RC-PL   | one 15 Amp | —               | 8            | silver brushed & anodized | yes           | —                      | —                  | —                 | —                | horizontal         | 9'          | 13½"          |
| A&E SPEC. # 96-939   | PD-815R-PL    | one 15 Amp | —               | 8            | flat black powder coat    | yes           | —                      | —                  | —                 | —                | horizontal         | 9'          | 13½"          |
| A&E SPEC. # 96-939   | PD-915R-PL    | one 15 Amp | 1               | 8            | black brushed & anodized  | yes           | —                      | —                  | —                 | —                | horizontal         | 9'          | 9"            |
| A&E SPEC. # 96-940   | PDS-615R      | one 15 Amp | —               | 6            | black powder coat         | —             | 6 step sequencing      | yes                | —                 | —                | horizontal         | 9"          | 9"            |
| A&E SPEC. # 96-940   | PDS-620R      | one 20 Amp | —               | 6            | black powder coat         | —             | 6 step sequencing      | yes                | —                 | —                | horizontal         | 9"          | 9"            |
| A&E SPEC. # 96-940   | PDS-2X315R    | two 15 Amp | —               | 6            | black powder coat         | —             | 6 step sequencing      | yes                | —                 | —                | horizontal         | 9'          | 9"            |

All of the above power distribution units are covered in UL File # 204950 and UL Standard 1419.

## LT-GN Series Interior Rack Lights

The LT-GN gooseneck work light features ultra bright LEDs for high visibility and plugs into USB ports on the front and rear of select power and lighting products or computers with standard USB ports. A flexible, silver gooseneck retains memory for easy positioning and a power switch is located on the top for convenience. LT-GN-PL also features a power supply with a standard 120V plug.

| Part #   | Description                             | Use With                         |
|----------|---|----------------------------------|
| LT-GN    | gooseneck work light with USB connector | PDLT-815RVx, PD-915RV-RN, LT-1Rx |
| LT-GN-PL | gooseneck work light with 120V plug     | any 120V receptacle              |



LT-GN operates via USB

## LT-1R Series Rackmount Light

View components easily with the LT-1R series rackmount lights. The retractable, dimmable LED bar illuminates automatically when opened. Two rear USB ports accept the LT-GN gooseneck light for viewing connectors, cables and rear of components. Designed with aesthetics in mind, the Designer Inspired LT-1RA and LT-1RC feature a dimmable logo with dimmer switches hidden underneath the retractable light. Constructed of 18-gauge steel, the one rackspace rackmount light is available with a flat black powder coat, silver brushed and anodized or black brushed and anodized finish. Includes power supply.



LT-GN-PL plugs into any 120V outlet

TIN/ELV COMPLIANT

A&E SPEC. # 96-01050

| Part # | Description                 |
|--------|-----------------------------|
| LT-1R  | flat black powder coat      |
| LT-1RA | black brushed and anodized  |
| LT-1RC | silver brushed and anodized |

LT-1R shown with dimmable light extended and lit



dimmable logo

front LT-1RA



front LT-1RC



dimmer knob

front LT-1R



two rear USB ports accept optional LT-GN gooseneck light

rear

## Magnetic Work Light

Designed for use when installing and servicing equipment, the WL-60 provides convenient illumination in rack enclosure interiors. The unit features a strong, scratch resistant magnetic base that attaches to any steel surface and a quadruple-jointed support arm makes it easy to aim the light, which stays where you put it. The WL-60 includes a 60 watt "rough-service" bulb, aluminum shade with on/off switch and an ultra-long 18' line cord that eliminates the need for an extension cord.

| Part # |
|--------|
| WL-60  |



WL-60



cUL US LISTED

# Decora® Mount Lighting and RPS Series Remote Power Switch



**LT-DEC**  
shown with light out and lit



**LT2P**



**LT2-T1P**

## LT-DEC Decora® Mount LED Light

A&E SPEC.  
# 96-01046

Designed to fit any standard Decora® opening, the LT-DEC opens and illuminates when pressed. Running on a standard included 12 VDC power source, multiple units can be daisy-chained together to use only one outlet with the JDC-12X18 jumper. The jumper reduces the number of power supplies required for an installation and can be used to power the LT-DEC Decora® light and TEMP-DEC Decora® temperature display, see pg. 85. Pre-configured panels are available with select pre-installed Decora® products.

| Part #  | Description  |
|---------|--|
| LT-DEC  | Decora® mount retractable LED light  |
| LT2P    | one space panel, pre-configured with 2 LT-DEC lights                                 |
| LT2-T1P | one space panel, pre-configured with 2 LT-DEC lights, 1 TEMP-DEC temperature display |

| Part #    | Description                           |
|-----------|---------------------------------------|
| JDC-12X18 | 18", 12 volt DC jumper wire, 2 pieces |

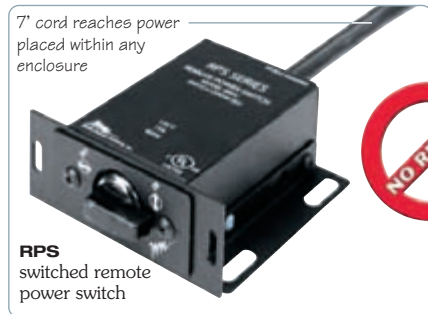

7' cord reaches power placed within any enclosure

**RPS**  
switched remote power switch

UL LISTED

## RPS Series Remote Power Switch

The RPS Series remote power switch provides the ability to power complete 15 Amp systems on and off without the need to access equipment. Perfect for installations where it is desirable to keep users from having the ability to make any adjustments, the RPS Series power switch mounts in the face of select racks, and is also available to mount in a single space panel or UCP Series Universal Connector Panel.

Available with a switch or with a keylock when security is a concern, the RPS has been tested in the most demanding situations and is UL Listed in the US and Canada for safety. The RPS fits in any Decora® opening, features removable ears and can also be mounted to any flat surface. The RPS has an internal 21 Amp switch (no relay!) for enhanced reliability and longevity.

DWR, SR, TOR and ISRK Series enclosures feature Decora® knockouts for mounting of the RPS Series remote power switch without the need for any additional accessories.

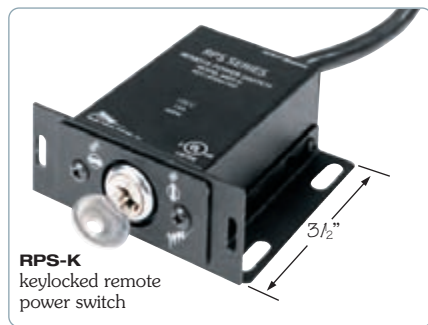

**RPS-K**  
keylocked remote power switch

A&E SPEC.  
# 96-01028

| Part # | Description                           |
|--------|---------------------------------------|
| RPS    | 15 Amp remote power switch            |
| RPS-K  | 15 Amp remote power switch, keylocked |

UL File #: E232496  
UL Standard #: 244A: Appliance Controls  
120 VAC, 15 Amps, 60 Hz

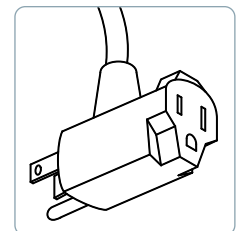

features easy to use "Piggy-back" 15 Amp plug

## Remote Power Switch



RPS Series remote power switch provides remote power control of system within enclosure, face, top and bottom of SR, DWR, PTRK and TOR enclosures

Need additional keys? Replacement sets are available, sold in sets of two.

| Part #  | Description              |
|---------|--------------------------|
| RPS-KEY | additional set of 2 keys |



# Thermal Management Best Practices

Maintaining the temperature inside racks and enclosures is critical to the proper functioning and survival of the circuits operating within. **Most studies have shown that for every 10°F rise over 85°F, digital equipment life is reduced by approximately 40%.** It is essential to ensure the heated air within the enclosure remains at a temperature of no more than 85°F to help protect sensitive equipment.

There are two approaches to securing an adequate internal enclosure temperature for the successful operation of the components enclosed: passive and active thermal management. Passive makes use of the ability of a properly configured system to ventilate through natural convection. In certain cases, however, the use of fans to force air through an enclosure (active) is necessary to maintain the desired internal temperature. Please refer to the nomograph located on the facing page to determine whether your system will require passive or active thermal management.

## Thermal Technique: Passive Thermal Management

The passive approach to thermal management involves capitalizing on natural airflow. Adequate vent openings in the top and bottom portions of an enclosure, as well as an unimpeded airflow, and placing hotter equipment lower in the rack will enhance the natural flow of air, as heat naturally rises. There is a **WRONG** and **PROPER** way to approach passive thermal management:

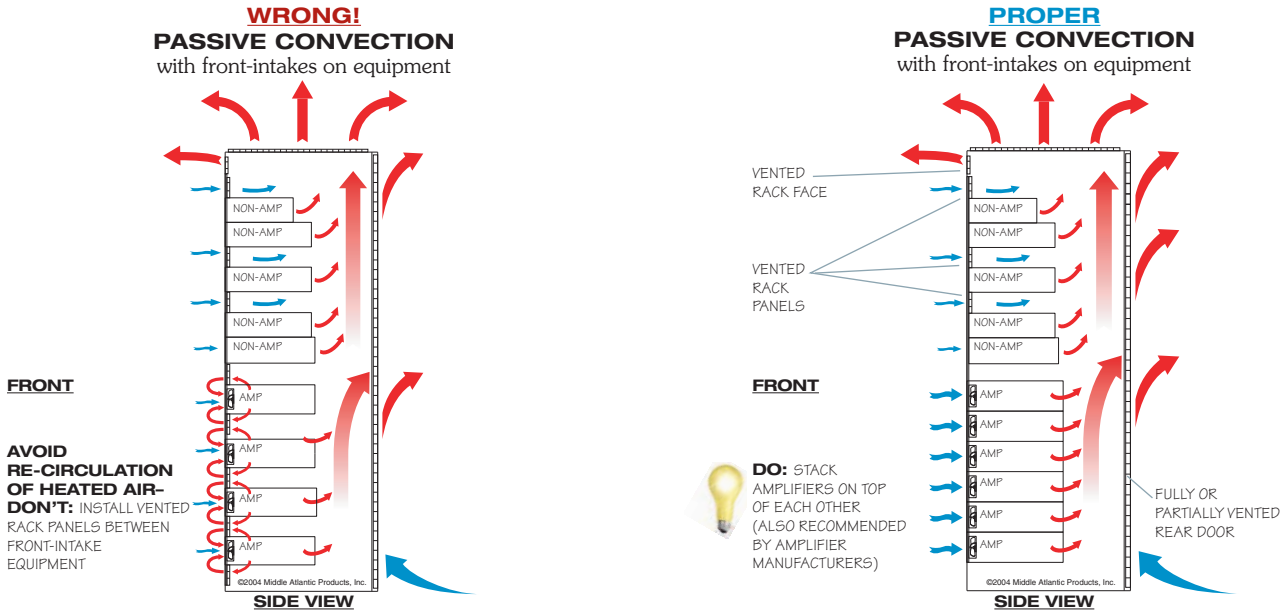

## Thermal Technique: Active Thermal Management

In many instances, equipment located within an enclosure will produce too much heat for passive thermal management (convection) to properly ventilate the enclosure. In this event, the use of forced air (fans) is instrumental to maintaining the optimal 85°F temperature recommended. Keys to the successful implementation of active thermal design include the use of top-mount fan(s) and no venting in the upper 6 rackspaces, upper sides, upper front or upper rear door to prevent short-circuiting of air at the top of the rack. There is a **WRONG** and **PROPER** way to approach active thermal management:

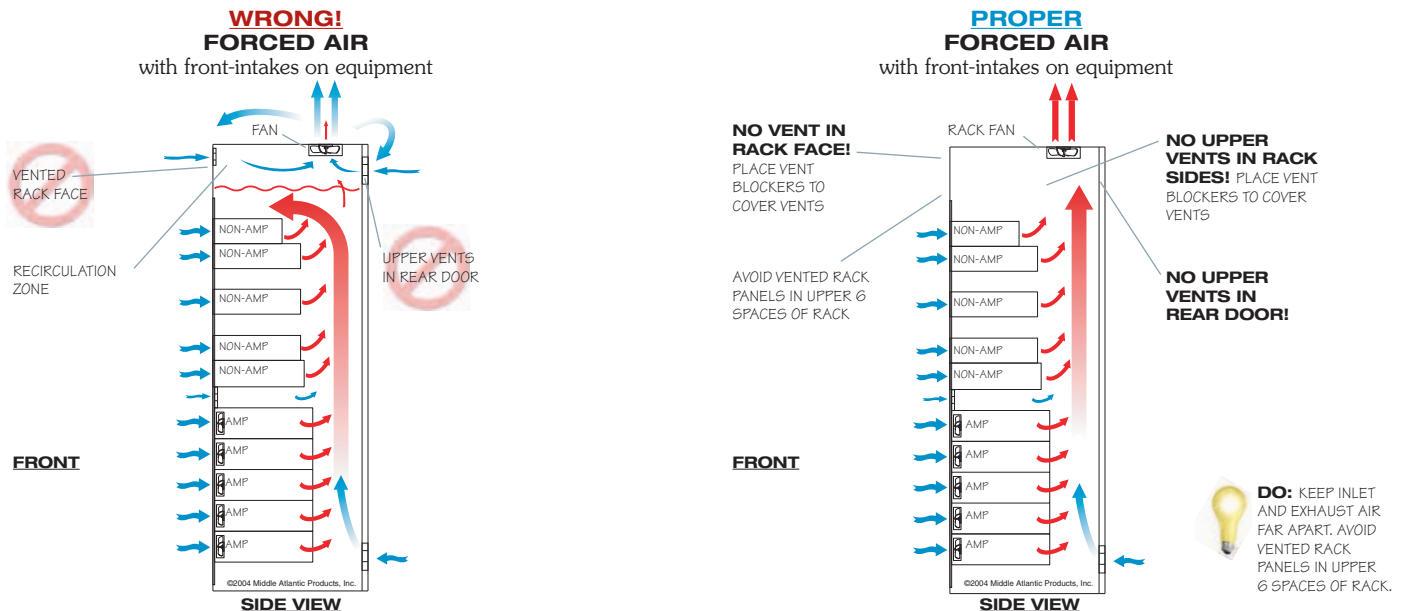

The key to successful active thermal management is ensuring there are no open vents at the top of the rack. The laws of static pressure dictate that fans will pull air from the easiest path (closest opening). This will create an undesirable recirculation of air, reducing heat removal if upper vents are not blocked.



# Thermal Management Best Practices

## How to Calculate Ventilation Required to Provide an Interior Rack Temperature of 85°F

This nomograph will show the minimum ventilation (active or passive) required, to provide an interior rack temperature of 85°F.

To calculate total waste heat (column B):

1. Obtain total waste heat output by combining the published waste heat BTU/Hr. of all amplifiers in the rack.
2. Add up total measured amperage draw from all other equipment and multiply by 400 (total amperage x 400 = total BTU/Hr. @117v.)
3. Combine BTU/Hr. totals from steps 1 and 2 to obtain total for all equipment. Mark total in column B.

To obtain minimum ventilation requirements:

1. Mark ambient room temperature in column C and connect points in B and C with a straight edge.
2. The minimum cooling required providing an interior rack temperature of 85°F will be shown on column A, where the straight edge intersects the minimum ventilation required column.

### Nomograph

Calculate ventilation required to provide an interior rack temperature of 85°F.

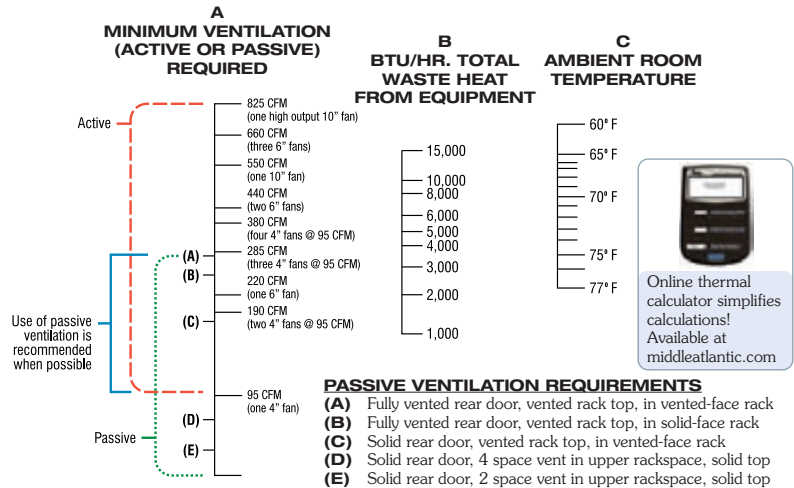

In addition to the proper configuration of the rack system, room design is critically important to the success of rack and enclosure thermal management. It is essential that not only does the equipment room have the ability to remove the heat generated by the racks, but also that racks are placed strategically within the room to ensure no-recirculation of air occurs.



The best start for thermal management is during the planning stages of new construction, by coordinating with architectural plans, building contractors HVAC plans and millwork specialists. However, regardless of whether planning is for a new or retrofit installation, there are several effective methods for thermal management that depend greatly on where the residential electronics system is being installed.

**A common residential installation features a visible rack face when it is mounted in millwork or a cabinet** - see pg. 86 for thermal management tips and tricks for residential installations.

For a complete guide to thermal management and controlling the temperature inside equipment racks, visit [middleatlantic.com](http://middleatlantic.com) to download the Thermal Management White Paper.

Consideration to a rack's internal airflow is equally important to ensure effective thermal management. Simulations and real-world testing show that moving air through a cabinet from bottom to top results in the lowest internal cabinet temperatures for equipment with front intakes.

### Best Enclosure Airflow Methods

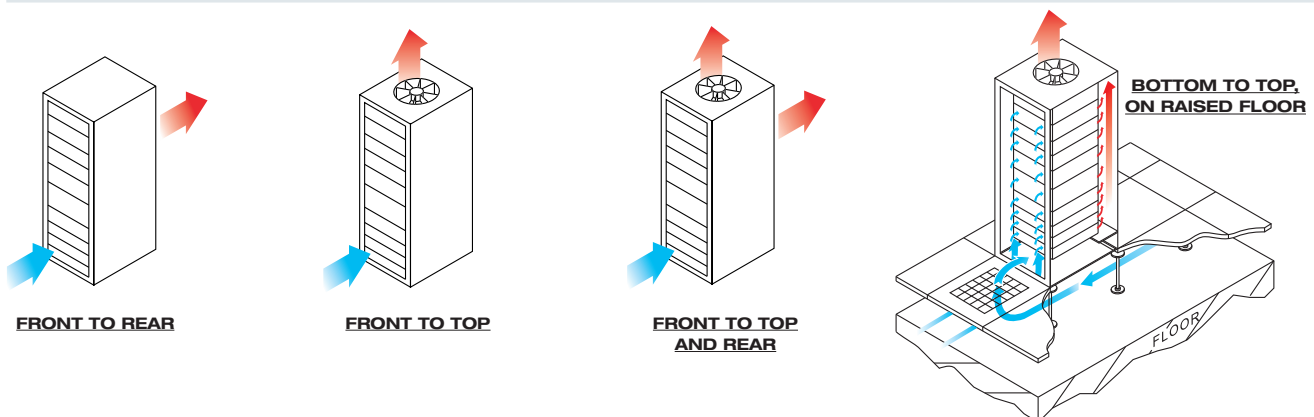



# Fans and Fan Panels

## Options For Optimal Thermal Management

| ACTIVE      |               |             |                 |               | PASSIVE       |                  |
|-------------|---------------|-------------|-----------------|---------------|---------------|------------------|
| Rack Series | Enclosure Top | Side Panels | Solid Rear Door | Vent Blockers | Enclosure Top | Vented Rear Door |
| DRK         | see pg. 84    | *required   | *required       | see pg. 85    | MW-VT, MW-LVT | standard         |
| WRK-SA      | see pg. 84    | standard    | standard        | see pg. 85    | MW-VT, MW-LVT | KO-VT3, pg. 85   |
| WRK         | see pg. 84    | *required   | standard        | see pg. 85    | MW-VT, MW-LVT | KO-VT3, pg. 85   |
| MRK         | see pg. 84    | *required   | standard        | see pg. 85    | MW-VT, MW-LVT | KO-VT3, pg. 85   |
| VRK         | see pg. 84    | *required   | standard        | see pg. 85    | MW-VT, MW-LVT | standard         |
| VMRK        | see pg. 84    | *required   | standard        | not required  | MW-VT, MW-LVT | n/a              |
| ERK         | see pg. 84    | standard    | standard        | see pg. 85    | ERK-VT        | KO-VT3, pg. 85   |
| DWR         | see pg. 84    | standard    | n/a             | see pg. 85    | not required  | n/a              |
| SR          | see pg. 84    | standard    | n/a             | see pg. 85    | standard      | n/a              |

\*Required - options required to properly configure system for designated thermal management technique.

## Quiet Fan Panel

Occupying three rackspaces, these quiet fan panel assemblies provide quiet cooling for demanding environments. Each assembly comes complete with fan(s) and grille(s) installed. Available in a black brushed and anodized, or black textured powder coat finish; cord and plug included.

| 120V Anodized Part # | 120V Textured Part # | 220V Anodized Part #** | 220V Textured Part #** | Racking Height   | Free Air dB Rating | # of Fans Installed | Free Air CFM |
|----------------------|----------------------|------------------------|------------------------|------------------|--------------------|---------------------|--------------|
| QFP-1                | QTFP-1               | QFP-1-119              | QTFP-1-119             | 5 1/4" (3 space) | <30 dBA            | one                 | 50           |
| QFP-2                | QTFP-2               | QFP-2-119              | QTFP-2-119             | 5 1/4" (3 space) | <33 dBA            | two                 | 100          |

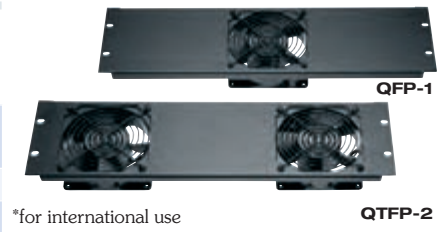

## Fan Panels

Fan panels accommodate all standard 4 1/2" fans. 3 rackspaces (5 1/4") high, they are made from 16-gauge flanged aluminum. Offered in a black textured powder coat or black brushed and anodized finish.

| Anodized Part # | Textured Part # | Racking Height   | Accommodates      |
|-----------------|-----------------|------------------|-------------------|
| FP1             | TFP1            | 5 1/4" (3 space) | one 4 1/2" fan    |
| FP2             | TFP2            | 5 1/4" (3 space) | two 4 1/2" fans   |
| FP3             | TFP3            | 5 1/4" (3 space) | three 4 1/2" fans |

**HOT TIP!** Save outlets using the multiple fan cord!



## Filter Kit

Made from 18-gauge perforated steel, the three space washable filter is 1" thick and mounts in enclosures for use as a filtered vent panel.

| Part # | Racking Height   |
|--------|------------------|
| FILTER | 5 1/4" (3 space) |



## Fans

Featuring smooth, ball-bearing design, the 120V and 220V fans mount flush and come in 4 1/2", 6" and 10" models. QFAN quiet fan includes guard with a black powder coat finish and is great for minimizing noise. AXS-FAN and AXS-FAN-K feature a slim design for mounting in AXS Series racks. 5-FAN-K includes all hardware **NEW** needed to mount in a Slim 5 rack. BMF-FAN10 provides 825 CFM of cooling for enclosures with high heat density. Hardware and cord included w/ each unit.

| 120V Part # | 220V Part #** | Size   | Depth  | Free Air dB Rating | Free Air CFM |
|-------------|---------------|--------|--------|--------------------|--------------|
| FAN         | FAN-119       | 4 1/2" | 1 1/2" | 39 dBA             | 95           |
| QFAN        | QFAN-119      | 4 1/2" | 1 1/2" | <30 dBA            | 50           |
| AXS-FAN     | AXS-FAN-119   | 4 1/2" | 1"     | 30 dBA             | 57           |
| AXS-FAN-K*  | -             | 4 1/2" | 1"     | 33 dBA             | 114          |
| 5-FAN-K*    | -             | 4 1/2" | 1"     | 33 dBA             | 114          |
| FAN-6       | -             | 6"     | 1 1/2" | 49 dBA             | 220          |
| FAN-10      | -             | 10"    | 3 1/2" | 49 dBA             | 550          |
| BMF-FAN10   | -             | 10"    | 4 1/4" | 60 dBA             | 825          |

\*includes 2 fans \*\*for international use



## Fan Guards

Fitting 4 1/2", 6" and 10" fans, fan guards are "Hamburger grille" style & have a flat black powder coat finish.

| Part #   | Fits       |
|----------|------------|
| GUARD    | 4 1/2" fan |
| GUARD-6  | 6" fan     |
| GUARD-10 | 10" fan    |

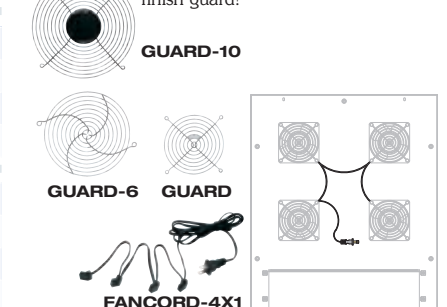

## Multiple Fan Cord

Save outlets by operating two, three or four fans from a single power outlet with the multiple fan cord. Not required for integrated fan tops.

| Part #      | Description                       |
|-------------|-----------------------------------|
| FANCORD-4X1 | fan cord, accommodates four fans  |
| FANCORD-3X1 | fan cord, accommodates three fans |
| FANCORD-2X1 | fan cord, accommodates two fans   |

A&E SPEC. # 96-01063



# Ultra Quiet Proportional Speed Thermostatic Fan Panels

## UQFP Series Ultra Quiet Fan Panels

A&E SPEC.  
# 96-01037

The two rackspace Ultra Quiet Fan Panel System provides smart cooling and monitoring to ensure a reliable installation in areas where fan noise is not an option, including boardrooms, classrooms, offices, houses of worship, etc. Thermostatic, proportional speed fan control ensures ultra quiet operation by varying fan speed based on enclosure temperature. Overtemp notification, local and remote, offers additional operation monitoring. A feature unique to this system provides notification in the event of fan failure via a local display or remote signal to an external alarm device.

- ✓ 100 CFM cooling capacity (4 Fan models), 50 CFM cooling capacity (2 Fan models)
- ✓ Digital processor varies fan speed based on enclosure temperature for ultra quiet operation
- ✓ Front panel rack temperature and alert display provides instant system status ('D' models only)
- ✓ On-board digital processor monitors rack temperature via external sensor
- ✓ Local and remote notification of over temperature and fan fault to control system

Compatible with most control systems!



| 120V Part # | NEW 220V Part #* | # of Fans | Overtemp Notification |               |        | User Definable Overtemp Setting | Fan Failure Notification Local & Remote Display | Free Air Rating | Max Sound Level | Racking Height |
|-------------|------------------|-----------|-----------------------|---------------|--------|---------------------------------|---|-----------------|-----------------|----------------|
|             |                  |           | Local LED             | Local Display | Remote |                                 |   |                 |                 |                |
| UQFP-2D     | IUQFP-2D         | 2         | ✓                     | ✓             | ✓      | ✓                               | ✓   | 50 CFM          | 24 dB           | 3½" (2 space)  |
| UQFP-4D     | IUQFP-4D         | 4         | ✓                     | ✓             | ✓      | ✓                               | ✓   | 100 CFM         | 27 dB           | 3½" (2 space)  |
| UQFP-2      | IUQFP-2          | 2         | ✓                     | -             | ✓      | -                               | -   | 50 CFM          | 24 dB           | 3½" (2 space)  |
| UQFP-4      | IUQFP-4          | 4         | ✓                     | -             | ✓      | -                               | -   | 100 CFM         | 27 dB           | 3½" (2 space)  |

\*for international use only



UQFP-4D



UQFP-4

## Designer Inspired Ultra Quiet Fan Panels

US PATENT # D537,935

The smart, quiet, elegant way to keep custom residential electronics systems cool and satisfy the most discriminating clientele. The two rackspace Designer Inspired Ultra Quiet Fan Panel features a unique on-board processor that controls fan speed in direct proportion to equipment temperature resulting in quiet, reliable installations. The perfect thermal management solution for media rooms, screening rooms, and other areas where people and electronics coexist, the Designer Inspired Ultra Quiet Fan Panel boasts the following features:

- ✓ 100 CFM cooling capacity
- ✓ Dimmable temperature and alert display provides instant system status - also available without front display
- ✓ On-board digital processor varies fan speed based on equipment temperature, which is monitored via external sensor
- ✓ Local and remote notification in the event of external sensor failure
- ✓ Local and remote notification of over temperature and fan fault to control system
- ✓ Available with a black brushed and anodized or silver brushed and anodized finish

Compatible with most control systems!



A&E SPEC.  
# 96-01037

| 120V Part #  | NEW 220V Part #* | # of Fans | Overtemp Notification |        | User Definable Overtemp Setting | Fan Failure Notification Local & Remote Display | Sensor Failure Notification | Free Air Rating | Max Sound Level | Finish | Racking Height |
|--------------|------------------|-----------|-----------------------|--------|---------------------------------|---|-----------------------------|-----------------|-----------------|--------|----------------|
|              |                  |           | Local Display         | Remote |                                 |   |                             |                 |                 |        |                |
| NEW UQFP-4RA | -                | 4         | -                     | -      | -                               | -   | -                           | 100 CFM         | 27 dB           | black  | 3½" (2 space)  |
| UQFP-4DRA    | IUQFP-4DRA       | 4         | ✓                     | ✓      | ✓                               | ✓   | ✓                           | 100 CFM         | 27 dB           | black  | 3½" (2 space)  |
| UQFP-4DRC    | -                | 4         | ✓                     | ✓      | ✓                               | ✓   | ✓                           | 100 CFM         | 27 dB           | silver | 3½" (2 space)  |

\*for international use only



NEW UQFP-4RA

UQFP-4DRA

UQFP-4DRC



# Thermostatic Fan Controls and Rack Top Options

## Proportional Speed Thermostatic AC Fan Control

Proportional speed thermostatic fan control extends both equipment and fan life and reduces service calls by varying the fan speed of up to four fans based on temperature. The fan control has 3 temperature ranges (80°-90°, 85°-95°, 90°-100°F) and can be set to operate the fan speed either proportional to temperature, or to come on full speed when the temperature threshold has been reached. This UL Listed device can also be turned on or off via a local switch, and includes status LEDs. Manufactured from 18-gauge steel with a durable black powder coat finish. A temperature probe is provided with a 5 ft. wire. This control is designed to work specifically with AC fans that are offered by Middle Atlantic Products, or other fans with similar specifications. Max fan load 1 Amp/120 volts. The FC-2-215-1C includes two NEMA 5-15R 15 Amp outlets.



| Part #      | Description   | # of Fan Outlets |
|-------------|---|------------------|
| FC-4        | mounts in MPR Series raceways (see pgs. 70-75)                            | 4                |
| FC-4-1C     | mounts to rackrail brackets or any flat surface                           | 4                |
| FC-2-215-1C | mounts to rackrail brackets or any flat surface, incl. two 15 Amp outlets | 2                |

## Top Options

Top options accept 4½", 6", or 10" fans for active thermal management. Adapter top option allows use with Duct Cool, see pg. 87. Vented pagoda tops maintain enclosure temperatures through natural convection while minimizing the amount of dust and debris that can fall into the rack, and adds 1½" to the top of the rack. Solid, slot pattern vented, large perf vented and cable ladder adapter tops also available.

| Fits WRK, MRK, VRK, VMRK, DRK Part # | Fits ERK, SCRK, WMRK, Part #* | Style   |
|--------------------------------------|-------------------------------|---|
| MW-4FT                               | ERK-4FT*                      | mounts four 4½" fans (MW-4FT) or three 4½" fans (ERK-4FT) |
| MW-6FT                               | ERK-6FT                       | mounts three 6" fans (MW-6FT) or two 6" fans (ERK-6FT)    |
| MW-10FT                              | ERK-10FT*                     | mounts one 10" fan  |
| MW-VT                                | ERK-VT                        | slot pattern vented                                       |
| <b>NEW</b> MW-DT                     | ERK-DT*                       | duct cool adaptor   |
| MW-LVT                               | -                             | vented, 64% open area                                     |
| MW-ST                                | ERK-ST*                       | solid   |
| MW-LA                                | -                             | accepts 6", 9" and 12" cable ladders                      |
| MV-PVTxx                             | -                             | vented pagoda top, MRK, VRK, VMRK only                    |

\*NOTE: black finish is standard, for granite gray finish suffix with 'GY', for light gray suffix with 'LG'. xx = depth of MRK, VRK and VMRK only (26", 31", 36" or 42").

## Integrated Fan Tops

Save time with Integrated Fan Tops! Ships assembled. Integrated fan tops include 10", 6" or 4½" fans, fan guards and optional proportional speed fan controller that increases fan life, reduces noise and maintenance!

| Part #           | # of Fans           | Fan Controller | Fits                    | Free Air CFM |
|------------------|---------------------|----------------|-------------------------|--------------|
| MW-4QFT-FC       | four 4½" quiet fans | included       | MRK,DRK,VRK,VMRK Series | 200          |
| MW-10FT-FC       | one 10" fans        | included       | MRK,DRK,VRK,VMRK Series | 550          |
| MW-4FT-380CFM    | four 4½" fans       | optional       | MRK,DRK,VRK,VMRK Series | 380          |
| MW-6FT-660CFM    | three 6" fans       | optional       | MRK,DRK,VRK,VMRK Series | 660          |
| MW-10FT-550CFM   | one 10" fans        | optional       | MRK,DRK,VRK,VMRK Series | 550          |
| ERK-4QFT-FC*     | three 4½" fans      | included       | ERK,SCRK,WMRK Series    | 150          |
| ERK-10FT-FC*     | one 10" fans        | included       | ERK,SCRK,WMRK Series    | 550          |
| ERK-4FT-285CFM*  | three 4½" fans      | optional       | ERK,SCRK,WMRK Series    | 285          |
| ERK-6FT-440CFM*  | two 6" fans         | optional       | ERK,SCRK,WMRK Series    | 440          |
| ERK-10FT-550CFM* | one 10" fans        | optional       | ERK,SCRK,WMRK Series    | 550          |

\*NOTE: black finish is standard, for granite gray finish suffix with 'GY', for light gray finish suffix with 'LG'.

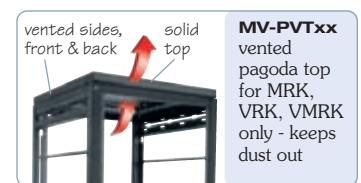
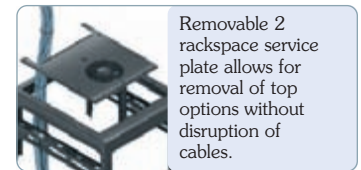

# Temperature Display And Thermal Management Products



A&E SPEC. # 96-01035

## Decora® Mount Temperature Display

How hot is your rack? The Decora® Mount Temperature Display monitors internal enclosure temperature, provides an LED readout and fits into any Decora® style opening. Features adjustable over temperature setting with local and remote notification. 9' cord with temperature probe and plug-in power supply included. Optional jumper supplies power to additional 12 VDC Decora® units using a single power source. DWR, SR and ISRK Series enclosures feature Decora® knockouts for mounting of the TEMP-DEC temperature display without the need for any additional accessories. See pg. 79 for other Decora® accessories.

| Part #    | Description                           |
|-----------|---------------------------------------|
| TEMP-DEC  | Decora® mount temperature display     |
| JDC-12X18 | 18", 12 volt DC jumper wire, 2 pieces |



Directs airflow upwards towards return air ducts



## High CFM Split Rear Doors **NEW**

Protect equipment from the damaging effects of heat from servers, NVRs and DVRs with the adjustable 6 fan High CFM Rear Door. This cupboard style split rear door pulls hot air from the rear of the cabinet and directs it up towards return air ducts. Fan placement is adjustable for optimal airflow and up to 10 additional fans can be added for up to 3520 CFM free air movement. Two adjustable half blank panels included for versatile fan arrangement. Additional half blank panels are available for greater control of fan placement.

| Part #      | Fits                               | Additional 1/2 Blank Panels | Free Air CFM |
|-------------|------------------------------------|-----------------------------|--------------|
| MW-CFRD-45  | 45 rackspace WMRK                  | MW-CFRD-1/2PNL-45           | 1,320        |
| MW-CFRD-44  | 44 rackspace WRK-SA, WRK, MRK, VRK | MW-CFRD-1/2PNL-44           | 1,320        |
| MW-CFRD-42  | 42 rackspace WMRK                  | MW-CFRD-1/2PNL-42           | 1,320        |
| MWCFRD-FKIT | additional 6" fan for MW-CFRD      |                             | 220          |

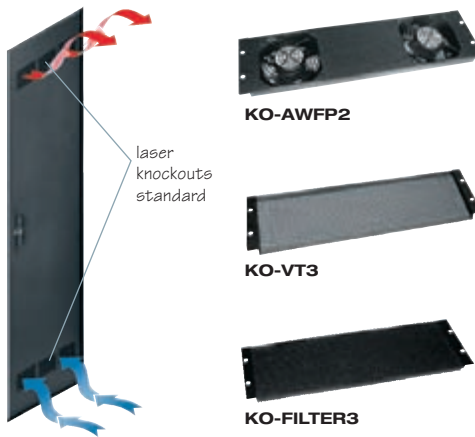

## Thermal Management Kits For Rear Doors

Middle Atlantic Products standard solid rear doors on WRK, MRK and ERK Series enclosures are configurable for achieving optimal active or passive thermal management. Fan, vent and filter kits are available to install after laser knockouts are removed. **NEW** fan and vent kits now available for solid split rear doors.

| WRK, MRK, ERK Standard Solid Rear Doors |                                | <b>NEW</b> Solid Split Rear Doors |   |
|---|--------------------------------|-----------------------------------|---|
| Part #                                  | Description                    | Part #                            | Description                                   |
| KO-AWFP2                                | fan kit with two fans, 190 CFM | KO-CRD-FAN                        | fan kit with two fans, 190 CFM, and two vents |
| KO-VT3                                  | vent panel kit                 | KO-CRD-VT                         | vent kit, four fans                           |
| KO-FILTER3                              | filter kit                     |                                   |   |
| KO-WSB3                                 | blank panel kit                |                                   |   |

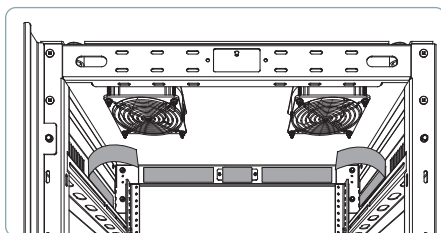

## Vent Blockers

VBK Series Vent Blockers are used to promote active thermal management. Designed to prevent the re-circulation of hot air between top-mount fans and nearby vent openings, Vent Blockers should be placed over the enclosure's vents located on the upper front of the enclosure, upper sides, and upper rear door (depending on enclosure). This will ensure that heated enclosure air will be forced out through the top-mounted exhaust fans instead of re-circulating, keeping equipment cool.

| Part #      | Used On                | Part #             | Used On               |
|-------------|------------------------|--------------------|-----------------------|
| VBK-W27-W32 | WRK-xx-27 & WRK-xx-32  | VBK-SD22           | SR-40-22, DWR-xx-22   |
| VBK-WSA27   | WRK-xxSA-27            | VBK-S28            | SR-xx-28              |
| VBK-WSA32   | WRK-xxSA-32, WR-xx-32* | VBK-S32            | SR-xx-32, DWR-xx-32   |
| VBK-E20     | ERK-xx20, DWR-xx-26    | <b>NEW</b> VBK-S42 | WR-xx-42*             |
| VBK-E25     | ERK-xx25               | VBK-V              | VRK-44-31H/VRK-44-36H |
| VBK-SCRK27  | SCRK Series            | VBK-DRK            | DRK Series            |
| VBK-D17     | DWR-xx-17              |                    |                       |

\*When WR is not flush against a wall, block the rear opening with the optional rear access panel, model # WR-RAP-xx

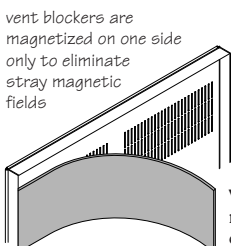



## Why is Thermostatic Control Important?

- ✓ Extends equipment life
- ✓ Minimizes noise
- ✓ Extends fan life
- ✓ Minimizes dust
- ✓ Reduces service calls



Thermal management solutions from Middle Atlantic Products have been designed and engineered to integrate aesthetically into any residential environment with little to no impact on the client. Intelligent technology such as thermostatic fan control ensures that the homeowner's electronics system will run optimally by monitoring system temperature and signaling fans to run automatically when necessary, benefiting the client as well as the installer.

## Open Shelves

Don't be misled by the open nature of a typical glass and metal television stand. It is still essential to ensure that electronics generating significant amounts of heat are able to breathe. Smaller intelligent fan systems like the Component Cooler are placed directly on the vents of the equipment's chassis, will sense when that satellite/cable box, A/V receiver or gaming console reaches a risky temperature, and work to circulate that hot air.

## When the Face of the Rack is Visible and the Rack is Mounted in Millwork or a Cabinet

The closed, isolated nature of cabinets and millwork often requires Active thermal management: the use of fans to properly ventilate heat produced by equipment. Intelligent fan panels installed at the top of the rack will help pull heated air out of the cabinet through the front of the rack, & into the room.

## In Cabinets or Entertainment Centers When the Rack is Covered by a Door

It is common for the homeowner to prefer his or her electronics system to be installed behind the scenes. Solid cabinet doors eliminate the opportunity to direct excess heat from the front of the rack. In these instances, an alternate exhaust system like the Cabinet Cooler or Duct Cool™ can be installed in the upper rear of the cabinet or entertainment center in which the rack will be located.



Designer Inspired  
Ultra Quiet Fan Panel see pg. 83

## In Closets

The installation of a large vertical rack in its own closet can also be preferable to the client, but carries the same challenges as smaller systems installed behind cabinet doors. The question again arises of where heated cabinet air can be exhausted, giving way to technologies like the Closet Cooler that can be installed in the top and bottom of a closet door to pull cool air in from the bottom of the system and exhaust heated air out of the top and into the hallway or room, or Duct Cool™ which can exhaust the heat into a crawlspace or conditioned area.

## Basement

When multiple systems are being distributed throughout the house, one recommendation is to locate home theater and media equipment in a vertical rack system in a basement or separate equipment room. Open areas such as these create more opportunities for passive thermal management, where the room is temperate enough and the rack is open enough for natural airflow to keep equipment adequately cooled. When equipment generates too much heat for natural convection to manage, the use of fans then becomes necessary and integrated fan tops can be utilized in a basement or a dedicated equipment room where ultra quiet fan operation is no longer a necessity.

## Component Cooler

Component cooler removes heat right at the source. Optimized for components on open shelving or in racks, this cooler features an integrated thermostatic control and turns on automatically when satellite/cable boxes, receivers, and other heat generating components get too hot. Place the component cooler directly on top of vents of equipment. The COMP-COOL-3 is available for systems that require multiple components to be cooled. Up to ten component coolers can be piggy backed to a single power supply. Includes compact power supply.

includes built-in  
thermostatic controller



COMP-COOL



| 120V Part #  | NEW 220V Part #** | Quantity                                      | Free Air Rating | Max Sound Level |
|--------------|-------------------|---|-----------------|-----------------|
| COMP-COOL    | ICOMP-COOL        | 1 fan   | 8 CFM           | 19 dB           |
| COMP-COOL-3* | ICOMP-COOL-3      | 3 fans, piggy backed to single power supply   | 8 CFM/Fan       | 24 dB           |
| COMP-COOL-E* | ICOMP-COOL-E      | 1 fan, piggy backs to COMP-COOL or COMP-COOL3 | 8 CFM           | 19 dB           |

\*36" length between connectors \*\*for international use

# Quiet-Cool Series™ Products



**CAB-COOL**

## Cabinet Cooler

Cabinet Cooler removes heat generated by components located in smaller cabinets, credenzas, lecterns and entertainment centers. Includes an in-line thermostatic control to operate only when needed. This quiet-cooling device features an aesthetically designed vent that can be painted to match its environment. Includes compact power supply.

| 120V Part # | <b>NEW</b><br>220V Part #* | Free Air Rating | Max Sound Level |
|-------------|----------------------------|-----------------|-----------------|
| CAB-COOL    | ICAB-COOL                  | 20 CFM          | 24 dB           |



includes in-line thermostatic controller

\*for international use



includes in-line thermostatic controller

**CLS-COOL1**

## Closet Cooler

Closet Cooler removes heat from equipment racks located in closets or large millwork cabinets. Larger installations located in closets have greater cooling requirements. All that will be visible are two solid oak vents, which can be stained or painted to match any room's décor. This cooling solution runs only when needed, mounts to a closet door and is available with an active exhaust and passive intake for closets with gaps, or an active exhaust and active intake for tightly sealed closets. Includes compact power supply.

| 120V Part # | <b>NEW</b><br>220V Part #* | Description                    | Free Air Rating | Max Sound Level |
|-------------|----------------------------|--------------------------------|-----------------|-----------------|
| CLS-COOL1   | ICLS-COOL1                 | active exhaust, passive intake | 50 CFM          | 25 dB           |
| CLS-COOL2   | ICLS-COOL2                 | active exhaust, active intake  | 50 CFM          | 28 dB           |

\*for international use



**DUCT-COOL-1PT**

**ALSO GREAT FOR COOLING ENCLOSED PROJECTORS!**

## Duct Cool™ **NEW**



Duct Cool™ is a complete remote cooling solution that allows you to manage the heat in closets, racks or enclosed projectors quietly and effectively. The Duct Cool™ system has been designed to remove heated air from equipment and vent it to an attic or conditioned space. The Duct Cool™ features a powerful, but quiet, inline mixed flow fan that is capable of removing heated air from up to 25 feet away, so the homeowner does not hear it operate. This unique cooling system turns on and off automatically and runs only when it's needed, making it an energy efficient thermal management solution. An optional thermostat is available for greater control. This product includes all needed mounting accessories, including 25' of insulated duct, and a decorative grill and air intake.

| Part #        | Free Air Rating | Free Air dB Rating* |
|---------------|-----------------|---------------------|
| DUCT-COOL-1PT | 135 CFM         | 35.7                |
| DUCT-COOL-2PT | 293 CFM         | 36.5                |



mixed flow fan produces a higher static pressure than centrifugal fans

| Part #  | Description                              |
|---------|--|
| THERM-A | optional thermostat, 60°F to 100°F range |

\*measured 1 meter from the air intake, centered horizontally and vertically, using 15' of straight insulated duct

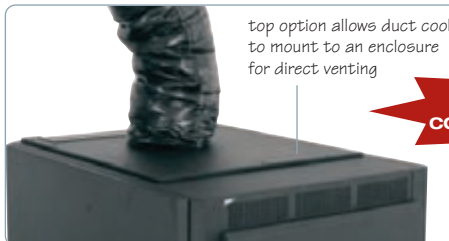

top option allows duct cool to mount to an enclosure for direct venting

**COMPATIBLE WITH MOST CONTROL SYSTEMS**



**THERM-A** optional thermostat for greater control

| Part # | Description                  |
|--------|------------------------------|
| ERK-DT | duct cool top for ERK        |
| MW-DT  | duct cool top for MRK or WRK |



# LCD Monitoring/Command Desk

A&E SPEC.  
# 96-01006

Equally suited for small surveillance applications to large-scale command and control environments, LCD Monitoring Desks are optimized for flat screens and ergonomically designed with the user in mind.

### Structural Features

- ✓ Modular design allows economical additions and limitless configuration choices
- ✓ LCD monitors can be mounted using optional monitor arms or placed on desks using manufacturer's stands
- ✓ Stable design will not tip; no leg extensions required
- ✓ Low profile light bridge (optional) allows better line of sight to video monitor walls
- ✓ Connecting wedges available in 45° and 90° for versatile monitoring setups
- ✓ 48" and 64" widths available
- ✓ Available in an attractive Dark Cherry, Honey Maple, Pepperstone and Slate finish
- ✓ Add-A-Bay™ models allow for economical expansion
- ✓ Half-height and full-height side panels available
- ✓ A full complement of accessories available to finish any installation

### Cable Management

- ✓ Power distribution and cable management cabinet features integral front and rear doors for convenient access

### Time Savings

- ✓ Assembles in minutes



**LD-6430PS**  
shown with optional accessories

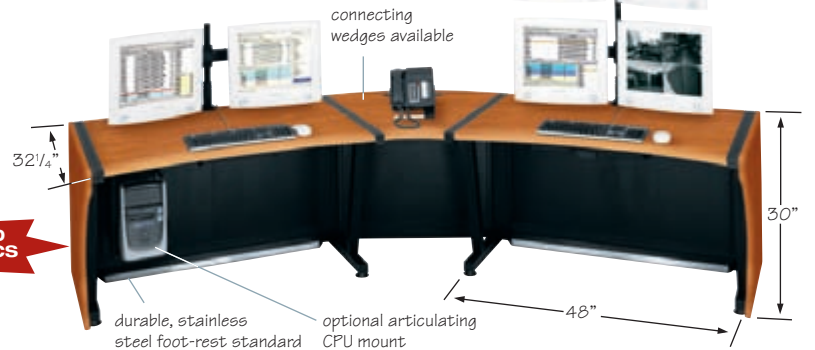

**LD-4830HM**  
shown with optional wedge and accessories



### Cable Management Cabinet Neatly Organizes All Wiring and Provides Space for Power Distribution

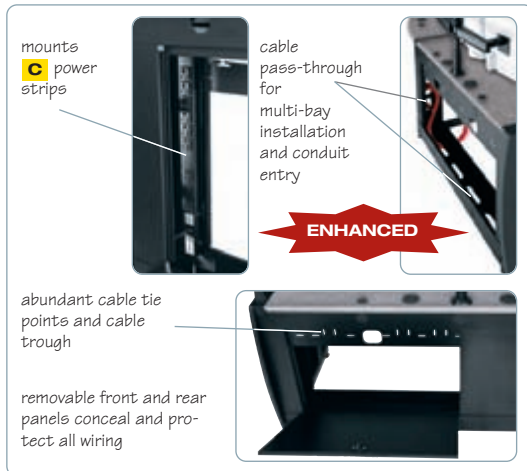

| Model #  | Overall Width | Light Bridge | Add-A-Bay™ Model # | Light Bridge Add-A-Bay™ | Standard Side Panels (Pair) | Full Height Side Panels (Pair) | Power Strip* |
|----------|---------------|--------------|--------------------|-------------------------|-----------------------------|--------------------------------|--------------|
| LD-4830* | 48"           | LD-L48       | LD-4830*-RA        | LD-L48RA                | LD-SP30_*                   | LD-PSP30_*                     | <b>C</b>     |
| LD-6430* | 64"           | LD-L64       | LD-6430*-RA        | LD-L64RA                | LD-SP30_*                   | LD-PSP30_*                     | <b>C</b>     |

\* When ordering, suffix part number with desired color (DC=Dark Cherry, HM=Honey Maple, PS= Pepperstone\*, SL=Slate\*).  
\*Pepperstone available for top, slate for side panels only.

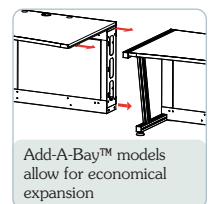



# LCD Monitoring/Command Desk Accessories

## Keyboard Shelf



LD-KB\*

|               |  |
|---------------|--|
| <b>Part #</b> | * When ordering, suffix part # with desired color (DC=Dark Cherry, HM=Honey Maple, PS= Pepperstone). |
| LD-KB*        |  |

Articulating shelf provides full adjustability, includes wrist-rest.

## Adjustable Phone Holder



|               |
|---------------|
| <b>Part #</b> |
| LD-TEL        |

Mounts to side channel & is fully adjustable.

## Pencil Tray



D-PT22

D-PT15

| Part # | Description          |
|--------|----------------------|
| D-PT15 | 15" wide pencil tray |
| D-PT22 | 22" wide pencil tray |

Mounts under desk and provides convenient storage for office supplies.

## Adjustable Light



|               |
|---------------|
| <b>Part #</b> |
| LD-LGM        |

Energy saving, low-voltage, fully adjustable fluorescent light conveniently mounts in grommet of desk or wedge.

## CPU Mounts



LD-CPU  
articulating mount

| Part #    | Description    |
|-----------|----------------|
| LD-CPU    | articulating   |
| LD-QCPUT* | isolation rack |

\* When ordering, suffix part # with desired color (DC=Dark Cherry, HM=Honey Maple, PS= Pepperstone).



LD-QCPUT-DC  
isolation rack

Available as an articulating under-desk mount or as an isolation rack with gasketed doors, sound isolation materials, fan and work surface.

## Monitor Mounts **ENHANCED**



| Part #   | Description           | Part #  | Description        |
|----------|-----------------------|---------|--------------------|
| LD-AM1X1 | 1, articulating       | LD-M3X1 | 3 across           |
| LD-M2X1  | 2 across              | LD-M2X2 | 2 across, 2 levels |
| LD-M3X1L | 3 across, low-profile | LD-M3X2 | 3 across, 2 levels |

Please call if you require a different configuration



Mount any LCD with a VESA 75 or VESA 100 mounting pattern. Mounts monitors with up to a 22" overall width. 25 lb. weight capacity per monitor.

## LCD Monitoring Desk Side Rack

| Part #   | Description                     |
|----------|---------------------------------|
| LD-1230* | single bay (12 space) side rack |

\* When ordering, suffix part # with desired color (DC=Dark Cherry, HM=Honey Maple, PS= Pepperstone).

NOTE: to mount LD-1230\* to a wedge requires an additional hardware kit - please call 800-266-7225 for details.



LD-1230HM  
shown with LD-4830HM

Optimized for use with CPUs, this 12 space side rack is available with a Dark Cherry, Honey Maple or Pepperstone finish and features side extrusions for seamless integration w/ LCD Monitoring Desks. Rear door & smoked plexi front door standard. Features pass-throughs for effective cable management between rack and desk. Includes locking casters.

## Wedges

| With Cable Management Cabinet | Without Cable Management Cabinet | Description |
|-------------------------------|----------------------------------|-------------|
| LD-W4530*                     | LD-WTT45*                        | 45°         |
| LD-W9030*                     | -                                | 90°         |



\* When ordering, suffix part # with desired color (DC=Dark Cherry, HM=Honey Maple, PS= Pepperstone).

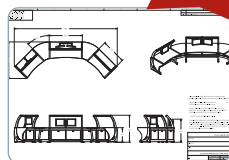

## Standard Colors **NEW**

|                      |                      |                                 |                                   |
|----------------------|----------------------|---------------------------------|-----------------------------------|
|                      |                      |                                 |                                   |
| DC<br>dark<br>cherry | HM<br>honey<br>maple | PS<br>pepperstone<br>(top only) | SL<br>slate<br>(side panels only) |



# Quiet-Cool Series™ Monitoring Consoles

UL US LISTED  
 SEISMIC CERTIFIED  
 TIA/EIA COMPLIANT  
 A&E SPEC. # 96-989

The Quiet-Cool Series™ is ideal for use in isolating noise created by DVRs, hard drive arrays and other equipment, which can have detrimental effects on the operator's attention and critical decision making ability. Engineered active thermal management ensures equipment stays cool, extending equipment life and reducing maintenance requirements.

### Structural Features

- ✓ Heavy-duty 14-gauge fully welded construction provides a 1,500 lb. weight capacity
- ✓ Unique 'zero-space' wedge allows consoles to connect corner-to-corner, requiring no additional space
- ✓ Front and rear rackrail standard
- ✓ Innovative slide out and rotating equipment rack available, provides convenient rear access to equipment connections and lifts off for offsite equipment integration and programming
- ✓ Pre-installed leveling feet allow height adjustment
- ✓ Available in a durable textured black, granite gray and light gray powder coat, additional colors available (please call for details)

### Thermal Management

- ✓ Keylocked lift-off solid side panels help manage airflow, and includes acoustic dampening material for sound isolation
- ✓ Standard gasketed front and rear doors provide sound isolation from noisy equipment, ensure effective thermal management, and feature a 3-point lock for security

### Cable Management

- ✓ 1/2", 3/4", 1" and 1 1/2" electrical knockouts on removable bottom rear plates
- ✓ Integral brush grommet allows front cable entry while maintaining air seal

### Time Savings

- ✓ Ships fully assembled to reduce installation time
- ✓ Adjustable rackrail features numbered rackspace increments to speed equipment mounting

### Code Compliancy

- ✓ Seismic Certified to the 1997 UBC and 2001 CBC Seismic Zone 4 and the 2000 IBC, 2003 IBC, 2002 ASCE Standard 7, and NFPA 5000 Seismic Use Group III lateral force requirements for protecting 375 lbs. of essential equipment in upper floor installations when used with optional SC-Z4 (see pg. 30) seismic floor anchor brackets with an I<sub>p</sub> value of 1.5 (does not include 'S' consoles with the slide out rotating rack bay)
- ✓ Grounding/bonding stud in base of console facilitates the proper grounding and bonding of electronic equipment, as per NEBS and NEC standards
- ✓ Base console UL Listed in the US and Canada

consoles with 60° slope provide enhanced line of sight

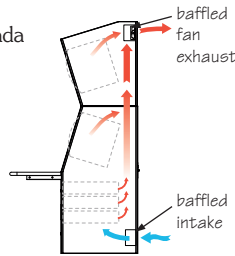

engineered Active thermal management ensures equipment stays cool



fan-assisted exhaust on rear door includes baffle for noise control



integral brush grommet allows front cable entry while maintaining air seal

removable solid top included



standard gasketed front door provides sound isolation from noisy equipment, and features a 3-point latch for security

narrow 22" width saves space

unique 'zero-space' wedge allows consoles to connect corner-to-corner, requiring no additional space

shown with optional foot-rest

ships fully assembled



unique lift off, slide out, and rotating equipment rack provides convenient rear access to equipment connections, includes lacer bars for cable management, and is available factory-installed in any console

**Configures in 1/3 of the time of knock-down consoles**

| Base Console       |                           |                        |               |                |               |               |               |  |                   |
|--------------------|---------------------------|------------------------|---------------|----------------|---------------|---------------|---------------|--|-------------------|
| Part #             | Bottom Bay Racking Height | Top Bay Racking Height | Top Bay Slope | Overall Height | Useable Depth | Overall Depth | Overall Width | Includes Slide Out Rotating Rack Bay** | Recommended Power |
| SCQ-1427-1217*     | 24 1/2" (14 space)        | 21" (12 space)         | 17°           | 51 7/8"        | 24"           | 27"           | 22"           | no                                     | C E G             |
| SCQ-1427-1217*-S** | 19 1/4" (11 space)        | 21" (12 space)         | 17°           | 51 7/8"        | 23"           | 27"           | 22"           | yes                                    | C E G             |
| SCQ-1427-1460*     | 24 1/2" (14 space)        | 24 1/2" (14 space)     | 60°           | 42 3/4"        | 24"           | 27"           | 22"           | no                                     | C                 |
| SCQ-1427-1460*-S** | 19 1/4" (11 space)        | 24 1/2" (14 space)     | 60°           | 42 3/4"        | 23"           | 27"           | 22"           | yes                                    | C                 |

\*When ordering, suffix part number with desired color (BK, GY, LG). \*\*Models with slide out rotating bay include factory installed foot-rest.

# Quiet-Cool Series™ Monitoring Console Options

## Rackmount Any Component



**RSH Series**  
custom rackshelves include a custom-cut aluminum bezel to provide an attractive, secure mount for any component

## Rackmount File Drawer



**TD8FLK**  
8 space locking rack drawer, accepts standard hanging files, black powder coat finish

## Power Distribution



**PD-1215J-S**  
12 outlet 15 Amp vertical power strip with J-Box

**PDLT-815RV-RN**  
rack light with 15 Amp power distribution, 8 outlets total, includes 2 stage surge suppression and remote notification

**PD-920R-NS**  
rackmount 20 Amp power strip 9 outlets total

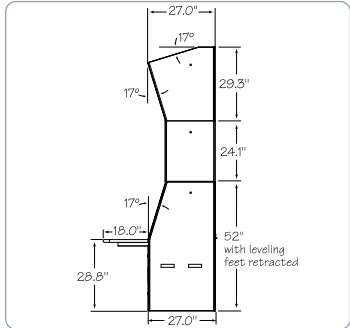

**SC-TK**  
stainless steel foot-rest available



**GR-30**  
flexible grommet for KO's protects cables



video lockboxes available



LCD Monitoring Desks also available

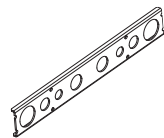

**ISO-KOP**  
bottom mount Electrical Isolation Knockout Panel features non-conductive EKO's to isolate electrical conduit from 60° consoles and connecting wedges

**GANG-10**  
ganging hardware for joining 10 consoles or top monitor racks

touch-up paint available, part # **WRINKLE** for black, **GY** for granite gray, **LG** for light gray



| Base Console        |                             |                      | Top Monitor Racks             |                            |                        |
|---------------------|-----------------------------|----------------------|-------------------------------|----------------------------|------------------------|
| Base Console Part # | Keylocked Side Panels, Pair | 45° Connecting Wedge | Add'l 10-32 Threaded Rackrail | Straight Face 12 Rackspace | 17° Slope 12 Rackspace |
| SCQ-1427-1217*      | SPNQ-1427-1217*             | SCW45-1427-1217*     | SC-RR27                       | SCQ3T-1427-1217-12*        | SCQ3T-1427-1217-1217*  |
| SCQ-1427-1217*-S    | SPNQ-1427-1217*             | SCW45-1427-1217*     | -                             | SCQ3T-1427-1217-12*        | SCQ3T-1427-1217-1217*  |
| SCQ-1427-1460*      | SPNQ-1427-1460*             | SCW45-1427-1460*     | -                             | -                          | -                      |
| SCQ-1427-1460*-S    | SPNQ-1427-1460*             | SCW45-1427-1460*     | -                             | -                          | -                      |



| TOP MONITOR RACK        |                             |                         |                               |                   |
|-------------------------|-----------------------------|-------------------------|-------------------------------|-------------------|
| Top Monitor Rack Part # | Keylocked Side Panels, Pair | 45° Connecting Wedge    | Add'l 10-32 Threaded Rackrail | Recommended Power |
| SCQ3T-1427-1217-12*     | SPNQ3T-1427-1217-12*        | SC3TW45-1427-1217-12*   | SC-RR12                       | <b>C</b>          |
| SCQ3T-1427-1217-1217*   | SPNQ3T-1427-1217-1217*      | SC3TW45-1427-1217-1217* | SC-RR12                       | <b>C</b>          |

\*When ordering, suffix part number with desired color (BK, GY, LG).

**FREE RACKTOOLS® DESIGN SOFTWARE**



**FREE DESIGN SERVICE!**

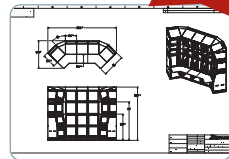

## Standard Colors





# Convective Series™ Monitoring Consoles

UL LISTED  
 SEISMIC CERTIFIED  
 TIA/EIA COMPLIANT  
 A&E SPEC. # 96-988

The Convective Series™ monitoring consoles provide advanced functionality at a competitive price and have been engineered to provide natural, convective cooling to extend equipment life and reduce maintenance.

### Structural Features

- ✓ Heavy-duty 14-gauge fully welded construction provides a 1,500 lb. weight capacity
- ✓ Unique 'zero-space' wedge allows consoles to connect corner-to-corner, requiring no additional space
- ✓ Front and rear rackrail standard
- ✓ Innovative slide out and rotating equipment rack available, provides convenient rear access to equipment connections
- ✓ Pre-installed leveling feet allow height adjustment
- ✓ Available in a durable textured black, granite gray and light gray powder coat, additional colors available (please call for details)

### Thermal Management

- ✓ Keylocked lift-off side panels feature engineered ventilation locations to facilitate convective cooling

### Cable Management

- ✓ 1/2", 3/4", 1" and 1 1/2" electrical knockouts on removable bottom rear plates
- ✓ Integral brush grommet allows convenient front cable entry

### Time Savings

- ✓ Ships fully assembled to reduce installation time
- ✓ Adjustable rackrail features numbered rackspace increments to speed equipment mounting

### Code Compliancy

- ✓ Seismic Certified to the 1997 UBC and 2001 CBC Seismic Zone 4 and the 2000 IBC, 2003 IBC, 2002 ASCE Standard 7, and NFPA 5000 Seismic Use Group III lateral force requirements for protecting 375 lbs. of essential equipment in upper floor installations when used with optional SC-Z4 (see pg. 30) seismic floor anchor brackets with an Ip value of 1.5 (does not include 'S' consoles with the slide out rotating rack bay)
- ✓ Grounding/bonding stud in base of console facilitates the proper grounding and bonding of electronic equipment, as per NEBS and NEC standards
- ✓ Base console UL Listed in the US and Canada

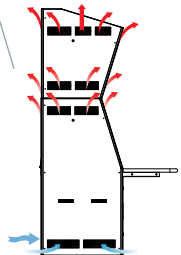
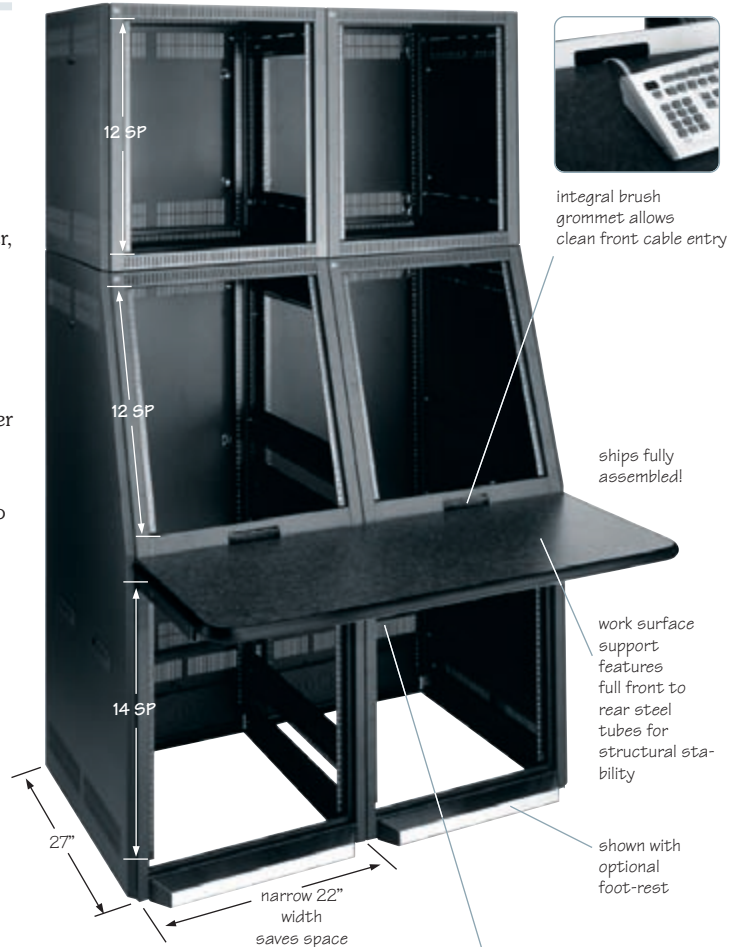

engineered ventilation locations promote proper Passive convective cooling, extending equipment life and reducing maintenance

**Configures in 1/3 of the time of knock-down consoles**



consoles with 60° slope provide enhanced line of sight



unique lift off, slide out, and rotating equipment rack provides convenient rear access to equipment connections, includes lacer bars for cable management, and is available factory-installed in any console

| Base Console      |                           |                        |               |                |               |               |               |  |                   |
|-------------------|---------------------------|------------------------|---------------|----------------|---------------|---------------|---------------|--|-------------------|
| Part #            | Bottom Bay Racking Height | Top Bay Racking Height | Top Bay Slope | Overall Height | Useable Depth | Overall Depth | Overall Width | Includes Slide Out Rotating Rack Bay** | Recommended Power |
| SC-1427-1217_     | 24 1/2" (14 space)        | 21" (12 space)         | 17°           | 51 7/8"        | 24"           | 27"           | 22"           | no                                     | C E G             |
| SC-1427-1217*_S** | 19 1/4" (11 space)        | 21" (12 space)         | 17°           | 51 7/8"        | 23"           | 27"           | 22"           | yes                                    | C E G             |
| SC-1427-1460_     | 24 1/2" (14 space)        | 24 1/2" (14 space)     | 60°           | 42 3/4"        | 24"           | 27"           | 22"           | no                                     | C                 |
| SC-1427-1460*_S** | 19 1/4" (11 space)        | 24 1/2" (14 space)     | 60°           | 42 3/4"        | 23"           | 27"           | 22"           | yes                                    | C                 |

\*When ordering, suffix part number with desired color (BK, GY, LG). \*\*Models with slide out rotating bay include factory installed foot-rest.

# Convective Series™ Monitoring Console Options

## Rackmount Any Component



**RSH Series**  
custom rackshelves include a custom-cut aluminum bezel to provide an attractive, secure mount for any component

## Rackmount File Drawer



**TD8FLK**  
8 space locking rack drawer, accepts standard hanging files, black powder coat finish

## Power Distribution



**PD-1215J-S**  
12 outlet 15 Amp vertical power strip with J-Box

**PDLT-815RV-RN**  
rack light with 15 Amp power distribution, 8 outlets total, includes 2 stage surge suppression and remote notification

**PD-920R-NS**  
rackmount 20 Amp power strip 9 outlets total

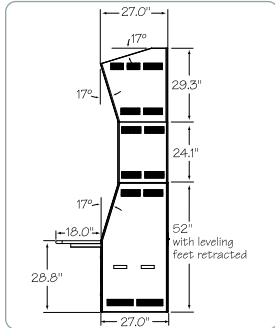

**SC-TK**  
stainless steel foot-rest available



**GR-30**  
flexible grommet for KOs protects cables



video lockboxes available



locking solid front door (**SCFD-14\***) w/ 3-point latch, 14 sp.



LCD Monitoring Desks also available

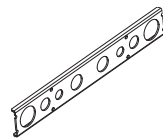

**ISO-KOP**  
bottom mount Electrical Isolation Knockout Panel features non-conductive EKO's to isolate electrical conduit from 60° consoles and connecting wedges



**GANG-10**  
ganging hardware for joining 10 consoles or top monitor racks



locking plexi front door (**SCPF-14\***) w/ 3-point latch, 14 sp.

touch-up paint available, part # **WRINKLE** for black, **GY** for granite gray, **LG** for light gray



| Base Console        |                             |                      |                               | Top Monitor Racks |                            |                        |
|---------------------|-----------------------------|----------------------|-------------------------------|-------------------|----------------------------|------------------------|
| Base Console Part # | Keylocked Side Panels, Pair | 45° Connecting Wedge | Add'l 10-32 Threaded Rackrail | Caster Base       | Straight Face 12 Rackspace | 17° Slope 12 Rackspace |
| SC-1427-1217*       | SPN-1427-1217*              | SCW45-1427-1217*     | SC-RR27                       | SC-CBS-27         | SC3T-1427-1217-12*         | SC3T-1427-1217-1217*   |
| SC-1427-1217*-S     | SPN-1427-1217*              | SCW45-1427-1217*     | -                             | -                 | SC3T-1427-1217-12*         | SC3T-1427-1217-1217*   |
| SC-1427-1460*       | SPN-1427-1460*              | SCW45-1427-1460*     | -                             | SC-CBS-27         | -                          | -                      |
| SC-1427-1460*-S     | SPN-1427-1460*              | SCW45-1427-1460*     | -                             | -                 | -                          | -                      |



| Top Monitor Rack Part # | Keylocked Side Panels, Pair | 45° Connecting Wedge    | Add'l 10-32 Threaded Rackrail | Recommended Power |
|-------------------------|-----------------------------|-------------------------|-------------------------------|-------------------|
| SC3T-1427-1217-12*      | SPN3T-1427-1217-12*         | SC3TW45-1427-1217-12*   | SC-RR12                       | <b>C</b>          |
| SC3T-1427-1217-1217*    | SPN3T-1427-1217-1217*       | SC3TW45-1427-1217-1217* | SC-RR12                       | <b>C</b>          |

\*When ordering, suffix part number with desired color (BK, GY, LG).

**FREE RACKTOOLS® DESIGN SOFTWARE**



**FREE DESIGN SERVICE!**

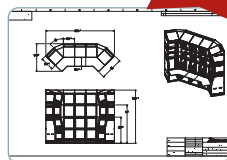

## Standard Colors





# SCRK/SCQRK Series Enclosures

UL LISTED  
 SEISMIC CERTIFIED  
 TIA/EIA COMPLIANT

A&E SPEC.  
 # 96-993 (SCRK)

A&E SPEC.  
 # 96-995 (SCQRK)

The SCRK/SCQRK Series 19" enclosures complement Quiet-Cool Series™ and Convective Series™ Monitoring Consoles. Available in full height and short versions, these enclosures can be used stand-alone or ganged to a console bay. (Quiet-Cool Series™ only available in short version)

### Structural Features

- ✓ Fully welded construction, combined with 16-gauge steel tops, bottoms, and sides, provides a 2,500 lb. weight capacity
- ✓ Locking rear door standard for additional security. SCQRK Series also includes locking gasketed solid front door
- ✓ Available with innovative slide out and rotating rack bay which provides convenient rear access to equipment connections
- ✓ Standard front and rear adjustable 11-gauge, 10-32 threaded rackrail with numbered rackspace increments to speed equipment mounting
- ✓ Pre-installed leveling feet allow height adjustment
- ✓ Available in a durable textured black, granite gray, and light gray powder coat, additional colors available (please call for details)

### Thermal Management

- ✓ SCQRK features gasketed front and rear doors, acoustic dampening material and fans for active thermal management
- ✓ Front and side ventilation locations on SCRK optimize passive convection
- ✓ Configurable open top on 44 space SCRK comes with standard vented top for passive thermal management, additional top options available

### Cable Management

- ✓ Laser knockouts for cable pass-through and ganging, aligns with all Middle Atlantic Products consoles
- ✓ 1/2", 3/4", 1" and 1 1/2" electrical knockouts found on removable rear plates, top knockout plate additionally includes UHF/VHF antenna knockouts
- ✓ Multiple lacing points and slotted rail brackets add cable management convenience to SCRK/SCQRKs
- ✓ Removable rear plates allow cable bundles to be easily passed over or under the standard key-locking rear door

### Code Compliancy

- ✓ Grounding/bonding stud in the base of enclosure facilitates proper grounding and bonding of electronic equipment, as per NEBS and NEC standards
- ✓ Seismic Certified to the 1997 UBC and 2001 CBC Seismic Zone 4 and the 2000 IBC, 2003 IBC, 2002 ASCE Standard 7, and NFPA 5000 Seismic Use Group III lateral force requirements for protecting 750 lbs. of essential equipment in upper floor installations when used with optional SC-Z4 (see pg. 30) seismic floor anchor brackets with an Ip value of 1.5 (does not include 'S' racks with the slide out rotating rack bay)
- ✓ UL Listed in the US and Canada

44 space model comes with removable vented top, additional top options available



fully adjustable front and rear rackrail

laser knockouts provide convenient cable pass-through when ganged to consoles, use GR-30 grommet to protect cables



numbered rackspace increments speed equipment mounting

27"

22"

**SCRK-4427GY**



**SCRK-1327GY** shown ganged to console bays with custom top option



**SCRK-4427GY** shown ganged to console bays

### SCQRK Quiet-Cool Series™ Enclosures

#### 27" Outside Depth

| Part #        | Racking Height     | Overall Height | Recommended Power | Includes Slide Out Rotating Rack Bay | Weight Capacity | Useable Depth |
|---------------|--------------------|----------------|-------------------|--------------------------------------|-----------------|---------------|
| SCQRK-1327*   | 22 3/4" (13 space) | 27 3/4"        | C                 | no                                   | 2,500 lbs.      | 24"           |
| SCQRK-1327*-S | 19 1/4" (11 space) | 27 3/4"        | C                 | yes**                                | 200 lbs.        | 23"           |

### SCRK Convective Series™ Enclosures

#### 27" Outside Depth

| Part #       | Racking Height     | Overall Height | Recommended Power | Incl. Slide Out Rotating Rack Bay | Weight Capacity | Useable Depth |
|--------------|--------------------|----------------|-------------------|-----------------------------------|-----------------|---------------|
| SCRK-4427*   | 77" (44 space)     | 81 7/8"        | N P R T           | no                                | 2,500 lbs.      | 24"           |
| SCRK-1327*   | 22 3/4" (13 space) | 27 3/4"        | C                 | no                                | 2,500 lbs.      | 24"           |
| SCRK-1327*-S | 19 1/4" (11 space) | 27 3/4"        | C                 | yes**                             | 200 lbs.        | 23"           |

\* Suffix part # with desired color (BK, GY, LG)

\*\* Models with slide out rotating rack bay include factory-installed foot-rests.



# SCRK/SCQRK Series™ Monitoring Console Options

## Top Options (44, 40, 35 space models)

|                         |  |  |   |
|-------------------------|--|--|---|
|                         |  |  |   |
| <b>ERK-ST*</b><br>solid | <b>ERK-10FT*</b> mounts (1) 10" fan<br><b>ERK-10FT-FC*</b> with fan + control<br><b>ERK-10FT-550CFM*</b> with fans | <b>ERK-6FT</b> mounts (2) 6" fans<br><b>ERK-6FT-440CFM</b> with fans | <b>ERK-4FT*</b> mounts (3) 4½" fans<br><b>ERK-4FT-FC*</b> with fans + control<br><b>ERK-4FT-285CFM*</b> with fans |

\* black is standard color, suffix with GY for granite gray, LG for light gray

## Power Distribution

|   |   |  |
|---|---|--|
|   |   |  |
| <b>PD-1215J-S</b><br>12 outlet 15 Amp vertical power strip with J-Box | <b>PD-2415SC-NS</b><br>15 Amp high density slim power strip fits 44 space SCRKS | <b>PDLT-815RV-RN</b><br>rack light w/ 15 Amp power distribution, 8 outlets total, includes 2 stage surge suppression and remote notification |

## Vertical Lacer Bars

|   |   |  |  |
|---|---|--|--|
|   |   |  |  |
| <b>LACE-44LP</b><br>44 space 3½" width lacer strip sold in packs of 6 | <b>LACE-P</b><br>45 space 2" wide lacer strip, sold in packs of 6 | <b>LACE-40-OP</b><br>40 space 3¼" wide lacer strip, sold in packs of 6 | <b>LACE-44-1SP</b><br>44 space 1" wide lacer strip with tapped holes, sold in packs of 6 |

## Copper Buss Bars

|  |  |  |
|--|--|--|
|  |  |  |
| <b>BB-40</b><br>40 space 2" wide copper buss bar | <b>BB-12</b><br>12 space 2" wide copper buss bar | <b>BB-44-1</b><br>44 space 1" wide copper buss bar |

**SC-TK**  
stainless steel foot-rest available

**GR-30**  
flexible grommet for KOs protects cables

video lockboxes available

**BR2**  
2 rackspace brush grommet panel for cable pass-through

Micro Fiber Cleaning Cloths keep anodized finishes & plexi doors clean

**ISO-KOP**  
bottom mount Electrical Isolation Knockout Panel features non-conductive EKO's to isolate electrical conduit from 60° consoles and connecting wedges

**GANG-10**  
ganging hardware for joining 10 consoles or top monitor racks

**VBK-SCRK27**  
vent blockers available for active thermal management

rackscrews available

touch-up paint available, part # **WRINKLE** for black, **GY** for granite gray, **LG** for light gray

| Rack Part #   | Solid Front Door | Plexi Front Door | Vented Front Door | Add'l 10-32 Threaded Rackrail | Caster Base | 45° Corner Wedge |
|---------------|------------------|------------------|-------------------|-------------------------------|-------------|------------------|
| SCQRK-1327*   | included         | -                | -                 | ERK-RR13                      | -           | SCRKW45-1327*    |
| SCQRK-1327*-S | included         | -                | -                 | -                             | -           | SCRKW45-1327*    |
| SCRK-4427*    | FD-44*           | PFD-44*          | VFD-44*           | ERK-RR44                      | SC-CBS-27   | -                |
| SCRK-1327*    | SCFD-13*         | -                | -                 | ERK-RR13                      | SC-CBS-27   | SCRKW45-1327*    |
| SCRK-1327*-S  | SCFD-13*         | -                | -                 | -                             | -           | SCRKW45-1327*    |

\*When ordering, suffix part number with desired color (BK, GY, LG)

**FREE RACKTOOLS® DESIGN SOFTWARE**

**FREE DESIGN SERVICE!**

## Standard Colors

|                    |                           |                         |
|--------------------|---------------------------|-------------------------|
|                    |                           |                         |
| <b>BK</b><br>black | <b>GY</b><br>granite gray | <b>LG</b><br>light gray |



# Console Configurations Simplify System Selection

The modular design of Quiet-Cool Series™ and Convective Series™ consoles allows for limitless configurations. The combination of base modules, top tiers, corner wedges and writing surface options allows designs that can match virtually any requirement, and assembles in 1/3 of the time of knock-down consoles. Whether the system requires active cooling, or natural passive convective cooling, it is easy to select the configuration that will meet the needs of each project.

Console configurations can be ordered quickly and easily with a single part number. Each configuration includes the same features and benefits that are an integral part of our consoles, including:

- ✓ Effective thermal management
- ✓ Welded construction – assembles in 1/3 of the time
- ✓ Standard locking rear doors
- ✓ Wedges feature locking rear doors for access to cable management

Each configuration comes complete with:

- ✓ Locking solid front door on each bay
- ✓ 25 rack screws per bay
- ✓ Ganging hardware
- ✓ 15 Amp power

When Passive cooling is needed, select Convective Series™ configurations, or choose Quiet-Cool Series™ for systems requiring Active cooling.

## Two Bay Console

| Convective Series™<br>Model # SC-2*         | Quiet-Cool Series™<br>Model # SCQ-2*        |
|---|---|
| 2 qty SC-1427-1217* base console            | 2 qty SCQ-1427-1217* base console           |
| 1 qty SPN-1427-1217* side panels            | 1 qty SPNQ-1427-1217* side panels           |
| 2 qty SCFD-14* locking front door           | 1 qty WS2-S18-GOF work surface              |
| 1 qty WS2-S18-GBF work surface              | 2 qty SC-TK toe-kick                        |
| 2 qty SC-TK toe-kick                        | 2 qty HPS, 50 rack screws total             |
| 2 qty HPS, 50 rack screws total             | 2 qty PD-815SC 8 outlet, 15 Amp power strip |
| 1 qty PD-815SC 8 outlet, 15 Amp power strip | 1 qty GANG-10 ganging kit                   |
| 1 qty GANG-10 ganging kit                   |   |

\*When ordering, suffix part number with desired color (BK, GY, LG)

## Three Bay Console

| Convective Series™<br>Model # SC-3*         | Quiet-Cool Series™<br>Model # SCQ-3*        |
|---|---|
| 3 qty SC-1427-1217* base console            | 3 qty SCQ-1427-1217* base console           |
| 1 qty SPN-1427-1217* side panels            | 1 qty SPNQ-1427-1217* side panels           |
| 3 qty SCFD-14* locking front door           | 1 qty WS3-S18-GOF work surface              |
| 1 qty WS3-S18-GBF work surface              | 3 qty SC-TK toe-kick                        |
| 3 qty SC-TK toe-kick                        | 3 qty HPS, 75 rack screws total             |
| 3 qty HPS, 75 rack screws total             | 3 qty PD-815SC 8 outlet, 15 Amp power strip |
| 2 qty PD-815SC 8 outlet, 15 Amp power strip | 1 qty GANG-10 ganging kit                   |
| 1 qty GANG-10 ganging kit                   |   |

\*When ordering, suffix part number with desired color (BK, GY, LG)

## Four Bay Console

| Convective Series™<br>Model # SC-4*         | Quiet-Cool Series™<br>Model # SCQ-4*        |
|---|---|
| 4 qty SC-1427-1217* base console            | 4 qty SCQ-1427-1217* base console           |
| 1 qty SPN-1427-1217* side panels            | 1 qty SPNQ-1427-1217* side panels           |
| 4 qty SCFD-14* locking front door           | 1 qty WS4-S18-GOF work surface              |
| 1 qty WS4-S18-GBF work surface              | 4 qty SC-TK toe-kick                        |
| 4 qty SC-TK toe-kick                        | 1 qty HP, 100 rack screws total             |
| 1 qty HP, 100 rack screws total             | 4 qty PD-815SC 8 outlet, 15 Amp power strip |
| 2 qty PD-815SC 8 outlet, 15 Amp power strip | 1 qty GANG-10 ganging kit                   |
| 1 qty GANG-10 ganging kit                   |   |

\*When ordering, suffix part number with desired color (BK, GY, LG)



### Standard Colors

**NEED SOMETHING YOU DON'T SEE? Please Call!**





# Console Configurations



SCQ-3W2BK

## Three Bay, 2 Wedge Console

| Convective Series™                          | Quiet-Cool Series™                          |
|---|---|
| Model # SC-3W2*                             | Model # SCQ-3W2*                            |
| 3 qty SC-1427-1217* base console            | 3 qty SCQ-1427-1217* base console           |
| 2 qty SCW45-1427-1217* base wedge           | 2 qty SCW45-1427-1217* base wedge           |
| 1 qty SPN-1427-1217* side panels            | 1 qty SPNQ-1427-1217* side panels           |
| 3 qty SCFD-14* locking front door           | 1 qty WS390-S18-GOF work surface            |
| 1 qty WS390-S18-GBF work surface            | 3 qty SC-TK toe-kick                        |
| 3 qty SC-TK toe-kick                        | 3 qty HPS, 75 rack screws total             |
| 3 qty HPS, 75 rack screws total             | 3 qty PD-815SC 8 outlet, 15 Amp power strip |
| 2 qty PD-815SC 8 outlet, 15 Amp power strip | 1 qty GANG-10 ganging kit                   |
| 1 qty GANG-10 ganging kit                   |   |

\*When ordering, suffix part number with desired color (BK, GY, LG)



SCQ-4W2BK

## Four Bay, 2 Wedge Console

| Convective Series™  | Quiet-Cool Series™  |
|---|---|
| Model # SC-4W2*   | Model # SCQ-4W2*  |
| 4 qty SC-1427-1217* base console                          | 4 qty SCQ-1427-1217* base console                         |
| 2 qty SCW45-1427-1217* base wedge                         | 2 qty SCW45-1427-1217* base wedge                         |
| 1 qty SPN-1427-1217* side panels                          | 1 qty SPNQ-1427-1217* side panels                         |
| 4 qty SCFD-14* locking front door                         | 1 qty WS245-S18-GOR +<br>1 qty WS245-S18-GOL work surface |
| 1 qty WS245-S18-GBR + 1 qty<br>WS245-S18-GBL work surface | 4 qty SC-TK toe-kick                                      |
| 4 qty SC-TK toe-kick                                      | 1 qty HP, 100 rack screws                                 |
| 1 qty HP, 100 rack screws                                 | 4 qty PD-815SC 8 outlet, 15 Amp power strip               |
| 2 qty PD-815SC 8 outlet, 15 Amp power strip               | 1 qty GANG-10 ganging kit                                 |
| 1 qty GANG-10 ganging kit                                 |   |

\*When ordering, suffix part number with desired color (BK, GY, LG)



SCQ-5W2-53TBK

## Five Bay, 2 Wedge, 3 Tier Console

| Convective Series™  | Quiet-Cool Series™  |
|---|---|
| Model # SC-5W2-53T*   | Model # SCQ-5W2-53T*  |
| 5 qty SC-1427-1217* base console  | 5 qty SCQ-1427-1217* base console   |
| 5 qty SC3T-1427-1217-12* top module   | 5 qty SCQ3T-1427-1217-12* top module  |
| 1 qty SPN3T-1427-1217-12* top module side panels                              | 1 qty SPNQ3T-1427-1217-12* top module side panels                             |
| 2 qty SC3TW45-1427-1217-12* top module wedges                                 | 2 qty SC3TW45-1427-1217-12* top module wedges                                 |
| 2 qty SCW45-1427-1217* base wedge   | 2 qty SCW45-1427-1217* base wedge   |
| 1 qty SPN-1427-1217* side panels  | 1 qty SPNQ-1427-1217* side panels   |
| 5 qty SCFD-14* locking front door   | 1 qty WS245-S18-GOL + 1 qty WS245-S18-GOR +<br>1 qty WS1-S18-GOC work surface |
| 1 qty WS245-S18-GBL + 1 qty WS245-S18-GBR +<br>1 qty WS1-S18-GBC work surface | 5 qty SC-TK toe-kick  |
| 5 qty SC-TK toe-kick  | 1 qty HP, 1 qty HPS, 125 rack screws total                                    |
| 1 qty HP, 1 qty HPS, 125 rack screws total                                    | 1 qty GANG-10 ganging kit   |
| 3 qty PD-815SC 8 outlet, 15 Amp power strip                                   | 5 qty PD-815SC 8 outlet 15 Amp power strip                                    |
| 1 qty GANG-10 ganging kit   |   |

\*When ordering, suffix part number with desired color (BK, GY, LG)



# Monitoring Console Work Surfaces

## Monitoring Console Work Surfaces

Console work surfaces are available with a beveled oak bullnose edge trim or an attractive economical black T-mold edge trim. All work surfaces are 1" thick and 18" deep, feature a durable graphite laminate top and include all necessary mounting hardware to simplify ordering. Included work surface support brackets do not impede any useable rackspace, maximizing the usability of each console bay. Additional laminate colors available, please call for details.



beveled oak trim



black t-mold trim



graphite desktop laminate

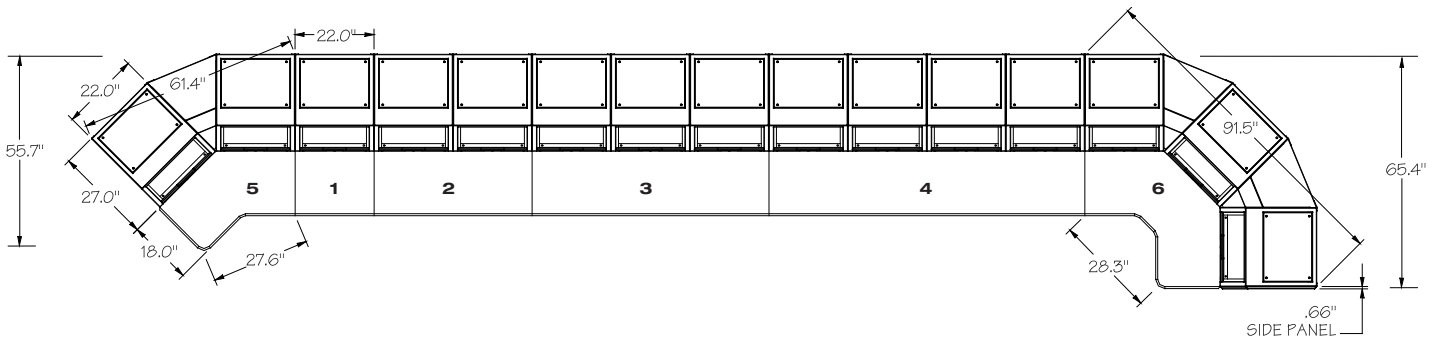

| Position | Description        | Beveled Oak Trim Part # | Black T-Mold Trim Part # |
|----------|--------------------|-------------------------|--------------------------|
| 1        | single bay         | WS1-S18-GO $\neq$       | WS1-S18-GB $\neq$        |
| 2        | two bay straight   | WS2-S18-GO $\neq$       | WS2-S18-GB $\neq$        |
| 3        | three bay straight | WS3-S18-GO $\neq$       | WS3-S18-GB $\neq$        |
| 4        | four bay straight  | WS4-S18-GO $\neq$       | WS4-S18-GB $\neq$        |
| 5        | 2 bay 45° corner   | WS245-S18-GO $\neq$     | WS245-S18-GB $\neq$      |
| 6        | 3 bay 90° corner   | WS390-S18-GO $\neq$     | WS390-S18-GB $\neq$      |

**NEED SOMETHING YOU DON'T SEE?**  
Please Call 800-266-7225

$\neq$  Suffix part # with desired finish/position (F, L, C, R), see below.

### Finish/Position



|          |  |
|----------|--|
| <b>F</b> | finished all sides                         |
| <b>L</b> | finished edge left (right side unfinished) |
| <b>C</b> | center (left and right side unfinished)    |
| <b>R</b> | finished edge right (left side unfinished) |



Please specify the finish and position of work surfaces - or contact our Customer Support Group and let us do it for you!

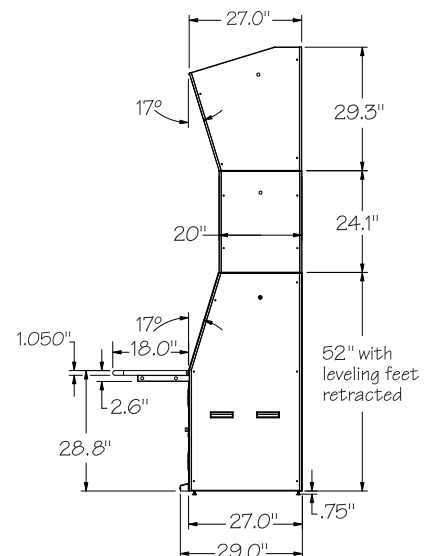



# Convenient Console Ordering Guide

## How To Determine Your Console Configuration

There are a number of factors to consider when deciding how many base console bays to order. Systems with single operators and multiple monitors can utilize base consoles with the addition of top monitor racks to achieve enhanced ergonomics and space efficiency, whereas multiple user systems with minimal monitoring requirements will benefit by utilizing a greater number of base consoles and may not require top monitor racks. When room dimensions are the prime constraint, please refer to the dimensioned drawing on pg. 98, download specifications from our website, or request a drawing from our Console Support Group to determine if the system required will fit in the room.

## Does The System Require Active Or Passive Thermal Management?

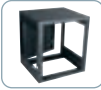
All electronic equipment produces heat. Many systems utilizing analog or fewer digital components will function very well utilizing convective cooling techniques. Choose our Convective Series™ consoles, which are designed to optimize natural convection, to help keep equipment cool in these systems. Systems utilizing mostly digital equipment or with high heat density will benefit from our Quiet-Cool Series™ consoles, which are designed with active thermal management, and include the added benefit of isolating the operator from noise generated by equipment. Please contact our Console Support Group if you have questions regarding thermal management techniques.

|   |   | Quiet-Cool Series™<br>"active"                                  | Convective Series™<br>"passive"                                 |
|---|---|---|---|
| <b>1. Determine # of Bays</b>   |   |   |   |
|   |    | SCQ-1427-1217* (17° slope)<br>SCQ-1427-1460* (60° slope)        | SC-1427-1217* (17° slope)<br>SC-1427-1460* (60° slope)          |
| <b>2. Select Top Monitor Racks if Required (available for 17° slope only)</b> |   |   |   |
| ✓ Sloped  |    | SCQ3T-1427-1217-1217*   | SC3T-1427-1217-1217*  |
| -or-  |   |   |   |
| ✓ Straight  |    | SCQ3T-1427-1217-12*   | SC3T-1427-1217-12*  |
| <b>3. Select Wedges if Required</b>   |   |   |   |
| ✓ Console Bay   |  | SCW45-1427-1217* (17° slope)<br>SCW45-1427-1460* (60° slope)    | SCW45-1427-1217* (17° slope)<br>SCW45-1427-1460* (60° slope)    |
| ✓ Sloped Top Monitor Rack<br>(available for 17° slope only)                   |  | SC3TW45-1427-1217-1217*<br>(for base consoles with a 17° slope) | SC3TW45-1427-1217-1217*<br>(for base consoles with a 17° slope) |
| ✓ Straight Top Monitor Rack<br>(available for 17° slope only)                 |  | SC3TW45-1427-1217-12*<br>(for base consoles with a 17° slope)   | SC3TW45-1427-1217-12*<br>(for base consoles with a 17° slope)   |
| <b>4. Add Side Panels</b>   |   |   |   |
| ✓ Console Bay   |  | SPNQ-1427-1217* (17° slope)                                     | SPN-1427-1217* (17° slope)                                      |
| ✓ Sloped Top Monitor Rack   |  | SPNQ-1427-1460* (60° slope)                                     | SPN-1427-1460* (60° slope)                                      |
| ✓ Straight Top Monitor Rack   |  | SPNQ3T-1427-1217-1217*<br>SPNQ3T-1427-1217-12*                  | SPN3T-1427-1217-1217*<br>SPN3T-1427-1217-12*                    |
| <b>5. Select Work Surface</b>   |   |   |   |
| ✓ With Beveled Oak Trim   |  | see facing page   | see facing page   |
| ✓ With Black T-Mold Trim  |  | see facing page   | see facing page   |

**Standard Colors** \*When ordering, suffix part number with desired color (BK, GY, LG), 3 interchangeable color choices complement all environments

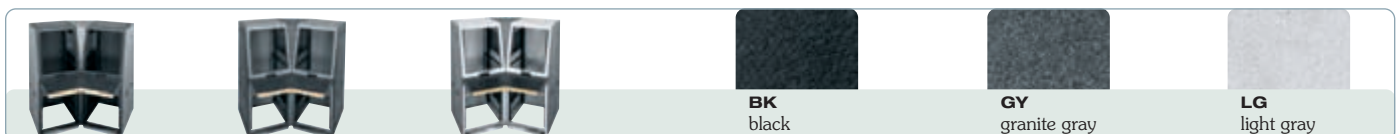



# Edit Center™ Multimedia Studio Furniture

Application designed studio furniture is equally suited for all editing environments including post production editing suites, corporate video production rooms, campus learning labs and broadcast production facilities.



All of the features of custom furniture, shipped from stock!

## Editing Desk Features

- ✓ Available in three **NEW** attractive finishes: Dark Cherry, Honey Maple and Pepperstone
- ✓ Matching contours of desktops and side bay racks allow for optimum positioning of computers and rackmount equipment
- ✓ Substantial 1" thick work surfaces
- ✓ Available in 84" and 60" widths
- ✓ Overbridge features 2 pivoting speaker platforms for optimal audio monitor placement
- ✓ Versatile system is available with choice of two 4 space bays, or an open space underneath the overbridge
- ✓ Producer/Client desks, without overbridge, are also available



Available in dark cherry, honey maple and pepperstone, each desk system has been specifically designed to fit any environment.



Every Edit Center™ side bay rack features a reversible adjustable-height top. This unique feature provides for left or right placement and allows the system to be easily configured with racks that slide under the desktop or join the desktop flush depending on preference.



The rear door features a factory-installed quiet cooling fan, plus a removable filter kit for air intake, while a brush grommet at the door bottom allows cable exit while maintaining a seal for noise and airflow. All Edit Center™ racks are assembled at the factory to save you time.



PD-815SC

Rear cable management/power distribution tray, accommodates **C** and **E** power strips, please see pgs. 64-79. Standard on all EDS, ES, EDL, EL, ESUR and ELUR.



S12-HM

ELUR + D12-HM

## Side Bay Rack Features

- ✓ Rack tops can be reversed for left or right hand placement, or lowered to slide underneath the desk top
- ✓ Available with doors, which feature a cooling system
- ✓ Side bay racks ship fully assembled, saving time



ES + S12-DC

S12-DC

## Standard Colors **NEW**



Two overbridge styles available to optimize your system: one features two 4 space rack bays angled for direct viewing, while the other features an open span underneath.



Two pivoting speaker platforms allow the placement of audio monitors at the optimum listening angle and are standard equipment on all Edit Center™ overbridges.



Matching contours on desktops and side bay racks allow for optimum positioning of computers and rackmount processing equipment.



EDL-PS  
Producer/  
Client desk

# Edit Center™ Multimedia Studio Furniture

## How To Order Edit Center™ Desks and Systems

Edit Center™ desks and side bay racks may be ordered using convenient single system part numbers, or by using individual component part numbers. Most Edit Center™ components are available with a Dark Cherry, Honey Maple or Pepperstone.

## Component Systems

\*When ordering, suffix part number with designation for desired top (DC= dark cherry, HM=honey maple, PS=pepperstone).



ES+S12D-HM

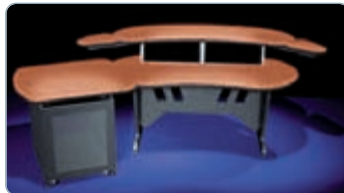

ESUR+S12D-HM



ELUR+S12D-HM



ELUR+D12D-HM

reversible tops allow side bay racks to be used on left or right side of desk, and join desktop flush or slide underneath



lay out your furniture system with our FREE RackTools® software, see pg. 134

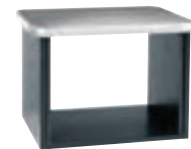

DT8PS

## System Part Numbers

### Desks + Side Bay Racks

| Part #      | Description  |
|-------------|--|
| ES+S12D-*   | 60" desk (incl. overbridge) + single bay outboard rack (w/door + cooling kit)                          |
| ESUR+S12D-* | 60" desk (incl. overbridge) w/(2) 4 space rackbays + 1 single bay outboard rack (w/door + cooling kit) |
| ELUR+S12D-* | 84" desk (incl. overbridge) w/(2) 4 space rackbays + 1 single bay outboard rack (w/door + cooling kit) |
| ELUR+D12D-* | 84" desk (incl. overbridge) w/(2) 4 space rackbays + 1 dual bay outboard rack (w/door + cooling kit)   |

## Component Part Numbers

| Part # | Description  |
|--------|--|
| ES-*   | 60" desk, includes overbridge                        |
| ESUR-* | 60" desk, includes overbridge w/(2) 4 space rackbays |
| EL-*   | 84" desk, includes overbridge                        |
| ELUR-* | 84" desk, includes overbridge w/(2) 4 space rackbays |
| EDS-*  | 60" producer/client desk, no overbridge              |
| EDL-*  | 84" producer/client desk, no overbridge              |



S12SD-HM



D12D-DC



S12D-PS

### Side Bay Racks Including Cooling

| Part #  | Description   | Weight Capacity |
|---------|---|-----------------|
| D12D-*  | 12 space dual bay outboard rack + doors/cooling system              | 500 lbs.        |
| D12SD-* | 12 space dual bay outboard rack w/square top+doors/cooling system   | 500 lbs.        |
| S12D-*  | 12 space single bay outboard rack + doors/cooling system            | 300 lbs.        |
| S12SD-* | 12 space single bay outboard rack w/square top+doors/cooling system | 300 lbs.        |
| S24D-*  | 24 space isolation rack w/square top+doors/cooling system           | 300 lbs.        |

side racks include front and rear rail

### Side Bay Racks, Open Front and Rear

| Part # | Description   | Weight Capacity |
|--------|---|-----------------|
| S12-*  | single bay outboard rack (12 rackspace), less doors | 300 lbs.        |
| D12-*  | dual bay outboard rack (12 rackspace), less doors   | 500 lbs.        |
| DT8*   | table top rack (8 rackspace)                        | 75 lbs.         |

side racks include front and rear rail

| Accessories |  |
|-------------|--|
| LD-AM1X1    | single LCD mount, articulating, black finish, 25 lb. weight capacity |
| E12DK       | front/rear door kit for 12 space racks                               |

\*Edit Center™ components require special shipping considerations. Please request shipping information when ordering



LD-AM1X1 single LCD mount, attaches to any Edit Center™ desk with included mounting clamp



S24D-HM



S12-DC



# Edit Center™ Equipment Racks

## Side Bay Racks

Standard on all systems, Side Bay Racks are available in either a single or dual bay configuration and come complete with casters. The reversible top is contoured to match the desktop, allowing the racks to be positioned at a comfortable angle to the user. Additionally, these racks feature a unique two position top height, allowing the user to determine whether the racks join the desk flush or slide under the desktop. 11-gauge, 10-32 threaded front and rear rackrail are set back 2" for equipment clearance.

### Cooling

Gasketed plexiglass front doors and gasketed laminated rear doors on selected racks control noise and open 95° on concealed hinges. The rear door features a built-in quiet fan for cooling plus removable filter kit, and a brush grommet at the door bottom allows cable exit while maintaining a seal for air flow. Single bay racks come standard with front and rear doors, while dual bay racks include doors on one bay only. Racks may also be ordered less doors. Side bay racks ship fully assembled.

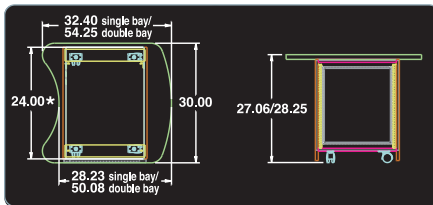

top view front view

12 space side bay rack (dimensions represent single and double bay widths) \*fan reduces useable depth on the top 4 rackspaces by 2"

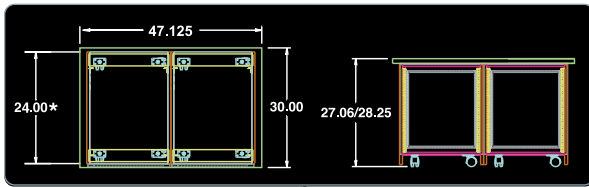

top view front view

12 space dual bay rack with straight top \*fan reduces useable depth on the top 4 rackspaces by 2"

**D12SD** with straight top



**D12D-DC**



**S12-DC**

Racks with factory-installed door kits include acoustical absorptive material to reduce system noise



**S12SD-HM**

all side bay racks feature standard front and rear rackrail

## Stand-Alone Racks

Available in 12 and 24 spaces, these racks include a plexiglass front door, a gasketed solid rear door, as well as internal acoustical absorptive material to reduce noise. Additionally, the rear door features a built-in quiet fan and filter, and a brush grommet at the door bottom allows cable exit while maintaining a seal for noise and airflow.

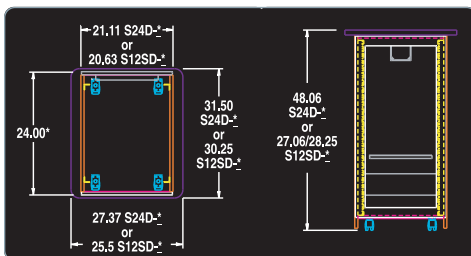

12 and 24 space isolation rack top view front view

\*fan reduces useable depth on the top 4 rackspaces by 2"



**S24D-HM**

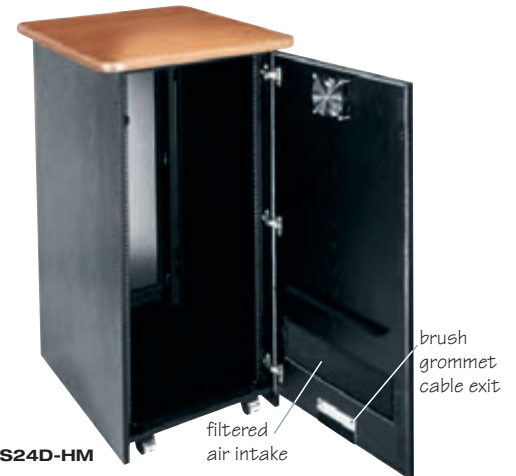

**S24D-HM**

## Desktop Rack

The DT8 provides an extra 8 rackspaces of desktop equipment mounting. Includes factory-installed 11-gauge, 10-32 threaded front rackrail.



**DT8PS**



A&E SPEC. # 96-01071

## Split Screen Pop Filter - For Professional Voice Overs

The revolutionary design of the Split Screen Pop Filter ensures superior performance. The Split Screen Pop Filter:

- ✓ Utilizes A.P.D.T.™ to eliminate pops
- ✓ Outperforms traditional hoop style pop filters
- ✓ 'Non-Parallel' surfaces eliminate resonant frequencies

### What is A.P.D.T.™?

Air Pressure Dispersion Technology (A.P.D.T.™) has been used in the development of the revolutionary Split Screen Pop Filter to remove all unwanted plosive 'P' and 'B' consonants. A.P.D.T.™ works by providing the optimal amount of open space between two engineered screens. The first screen diffuses the air that allows plosive consonants to impact the microphone diaphragm. The open space between the screens disperses air pressure that can build in hoop style pop filters, while the second screen removes any remaining plosive consonants.

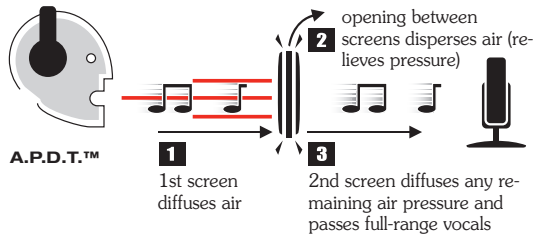

| Part # | Description                    |
|--------|--------------------------------|
| PF-SS  | split screen pop filter, black |

## Speaker Stands

The Edit Center™ Speaker Stands are optimized to accommodate near and mid-field audio monitors in video and audio production and editing facilities. Featuring high-mass all wood construction for resonance damping, these 36" tall speaker stands include both carpet spikes and rubber feet to accommodate all floor surfaces. The unique dual cable channels separate audio and AC cables (when using powered monitors), and include an attractive wide molded cover. Speaker platforms and bases measure 15¾" x 15¾". The elegant curved supports are finished in a durable black texture-lac coating. Sold in pairs.



| Part #    |
|-----------|
| EC-SPK36* |

\*Suffix part number with desired color (DC=Dark Cherry, HM=Honey Maple, PS=Pepperstone)

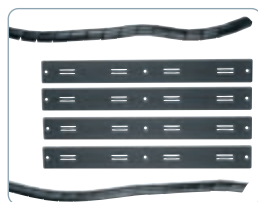

## Cable Management Kits

These convenient cable management kits effectively organize the mass of cable typically found in digital video and audio systems. Kit consists of spiral wrap to contain cables, and flat panels with tie-points to manage cable under desktops.

| Part # | Description   |
|--------|---|
| CM-L   | cable management kit for 84" desk system, incl. 8 cable managers & 20' cable wrap |
| CM-S   | cable management kit for 60" desk system, incl. 4 cable managers & 20' cable wrap |

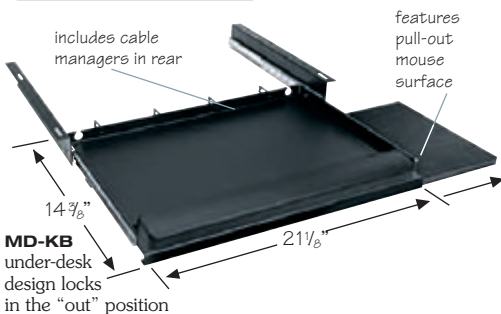

## MD-KB Keyboard tray

Designed for under-desk use, the MD-KB computer keyboard tray is equipped with a padded wrist support. The unit's built-in mouse tray can be pulled out to either the left or right side and retracts out-of-the-way when not in use. All mounting hardware included. (Does not work with MDV-CNR1 or MDV-CNR3.)

| Part # |
|--------|
| MD-KB  |

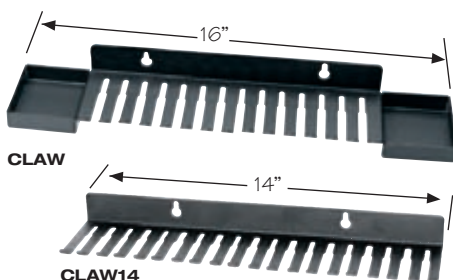

## "The Claw" Cable Hanger

The unique dual-size "claw" configuration of this versatile wall mount cable hanger provides efficient storage for all cables large and small. Available with side trays for holding small items, or without side trays for increased storage density. Black powder coat finish.

| Part # | Dimensions                           |
|--------|--------------------------------------|
| CLAW   | 16" w x 3 1/2" deep, with side trays |
| CLAW14 | 14" w x 3 1/2" deep                  |





Utilizing a modular design, the MultiDesk Video™ System allows the configuration of furniture to accommodate any work environment. Whether you're a corporate video editor, digital audio engineer, or free-lance graphic artist, you can combine the models in the series to create a system that meets your specific requirements. Featuring an attractive 1" thick top with a graphite finish and sturdy steel-tube legs, the MultiDesk Video™ system makes application-designed multimedia furniture available to those who previously had to choose an office desk or other furniture ill-suited for the job.



## 59" Video Desk

**29 1/4" to 30 3/8" Adjustable Desktop Height** - The taller MDV-DL allows MultiDesk Video™ racks to slide underneath, saving space.

- ✓ open overbridge accommodates multiple video monitors
- ✓ larger 59" width provides more workspace



**Part #**  
MDV-DL

## Corner Desk

**26 1/2" to 27 1/2" Desktop Height** - The MDV-CNR1 Corner Desk includes a one piece overbridge that is user-configurable three ways:

- ✓ one 4 space rackbay in center, or
- ✓ two 4 space rackbays on sides, or
- ✓ middle supports justified to outside to provide a 32" wide open center span

Overbridge provides 7" inside height clearance



**Part #**  
MDV-CNR1

## Corner Desk

**26 1/2" to 27 1/2" Desktop Height** - The MDV-CNR3 Corner Desk includes a three piece overbridge specifically designed to accommodate mixers with tall meter bridges. The overbridge center section is user-configurable two ways:

- ✓ 11 1/4" inside height clearance, or
- ✓ 16 1/2" inside height clearance

Center section provides 30" inside width clearance



designed to accommodate digital audio mixers from Panasonic, Yamaha, etc.



**Part #**  
MDV-CNR3

## Corner Desk

**26 1/2" to 27 1/2" Desktop Height** - The MDV-DSK Straight Desk includes an overbridge that is user-configurable two ways:

- ✓ two 4 space rackbays, or
- ✓ remove center section to provide 39" wide open span

Overbridge provides 7" inside height clearance



**Part #**  
MDV-DSK





MDV-R12

S12SDG

## Side Bay Rack

Add an MDV-R12 Side Bay Rack to any MultiDesk Video™ Series desk for additional rackmount capacity and desktop space. Top constructed from high quality 1" thick MDF with black laminate, provides 12 rackspace, includes front rail. Casters are optional.

| Part #  | Useable Depth |
|---------|---------------|
| MDV-R12 | 23½"          |

Add an S12SDG side rack to the MDV-DL 59" video desk if a plexi front door, and rear door with a built-in quiet fan for cooling are desired. Provides 12 rackspace, includes front and rear rackrail, and comes complete with casters. This rack slides under the surface of the MDV-DL only, *not compatible with other MultiDesk Video™ desks.*

| Part # | Useable Depth |
|--------|---------------|
| S12SDG | 24"           |



MDV-CK

## Caster Kit

Caster Kit for MDV-R12 includes four wheels, two metal caster saddles, and mounting hardware. Raises rack by 5/16".

| Part # |
|--------|
| MDV-CK |

MDV-OB4



## Overbridge

The MDV-OB4 Overbridge mounts on top of the MDV-R12 rack and provides an additional 4 rackspace. When placed beside any MultiDesk Video™ Series desk, a contiguous surface is maintained.

| Part #  |
|---------|
| MDV-OB4 |



MDV-W

## Connecting Wedge

Use the MDV-W Connecting Wedge to connect any MultiDesk Video™ Series component at an ergonomic 35° angle. Mounting hardware is provided.

| Part # |
|--------|
| MDV-W  |

# Cable Management Best Practices

Having a system that is easy to service and upgrade will benefit both the installer and the customer. Proper cable management is also essential for reducing signal noise - to effectively help this, 2" separation is recommended between AC power cables and signal wires, when they are run parallel (**when using Signal Safe™ power cables, 1/2" separation is recommended, see pg. 65.**) When care is given to planning the management of cable entering the rack or enclosure system and maintaining it neatly throughout the system, the goal of providing the end-user with a neat, organized, effective and reliable system is easily attained.



## Methods of Bringing Cable Into Your Enclosure or Rack System

### Cable Entry: From Above Through Top of Rack

Welded floor standing enclosures come standard with wide-open tops for large cable bundles to enter the enclosures.

Standard enclosure with wide-open top – cable is brought in from above.



Standard enclosure with MW-10FT top option shown – aluminum panel is removed to bring cable bundle into the enclosure. Top can be replaced after cabinet has been cabled.



The cable ladder top option for DRK, WRK, MRK, VRK and VMRK Series enclosures accepts a 6", 9" or 12" wide cable tray or cable ladder (model # MW-LA). This top allows for a cable tray to attach coming in from front or rear and left or right. The opening in the top also allows for the use of a cable drop (model # CLH-ED11 or CLH-SD8) on the cable ladder to maintain proper bend radius of the cable. See pg. 28 for top options, and pg. 114 for cable ladders.

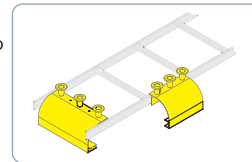

### Cable Entry: From Below Through Bottom of Rack

The bottoms of welded floor standing enclosures are designed with an open base to accept large cable bundles. There is 1½" to 3" of space (depending on the enclosure) in the bottom before reaching the rackspace area to allow for cable entry up into the enclosure. Each enclosure's unique "upformed base" provides maximum interior room for cable management and storing unused wire.



A full line of Riser Bases (RIB Series) and Seismic Riser Bases (SRB Series) are available and provide additional clearance off the floor and can be used for cabling below each enclosure or cabling from one to another when ganged. Laser knockouts on the ends are provided for ganging RIBs to pass cables through. See pgs. 26-27 for riser bases.



When the Riser Bases are used with V-FEET and angles it allows the installer to firmly attach enclosures to the sub floor in Raised Floor/ Access Floor applications.



### Dressing Cables Internally

In racks where a high density of cables are anticipated, it is often helpful to cut cable and bundle for testing the bend radius. Many times integrators find out too late that the cable simply cannot be effectively run. Prior testing allows better planning.



### Vertical Lacer Strips

Vertical lacer strips are designed to mount to the rail brackets in all Middle Atlantic Products enclosures. Add as many lacer strips as necessary to bring the maximum amount of cable into the enclosure, while keeping power and signal separate. The vertical strips allow the installer to lace cable from the top to the bottom of the rack or vice-versa. Use the **NEW** Anti-Slip Cable Pad with LACE-OWP vertical lacer strips to reduce cable strain.



### When to Use Hook and Loop Style Ties

Hook and loop style cable fasteners such as the TW12 should be used when installing cable that is sensitive to strain, when the wrap is so tight that it affects the performance of the cable or when cable will be added to or removed from the bundle on a regular basis. These cable management straps can be opened and reused, unlike wire ties. Cable bundles pre-wrapped with cable management straps slide over the convenient tie posts of LACE-OWP and LACE-OP strips. This feature saves time in the shop and the field, as it eliminates the need to fish in cable ties or straps.

# Cable Management Best Practices

## Horizontal Lacer Bars

Most Middle Atlantic Products enclosures are furnished with a set of rear rackrail that can be used to mount horizontal lacer bars at any height. Horizontal lacer bars address two common problems: cable strain relief and running cables from one side of the rack to the other. They can also be used to provide rear support for rackmount equipment.

Use lacer bars when running cables horizontally



Use lacer bars as strain relief for connectors



Middle Atlantic Products offers different style lacer bars for different applications. Determine which lacer bar is appropriate for the application (see pg. 110 for complete list of model #s).

### Use LBP-LTF or UP1P Horizontal Lacer Panel When

- ✓ Running large cable bundles horizontally
- ✓ Rear support for equipment is required
- ✓ More surface is desired to mount wires
- ✓ Combination cable lacing and device mounting



UP1P



LBP-LTF

### Use Flat LBP-1S Lacer Bar When

- ✓ Running large cable bundles vertically
- ✓ Running cable bundles horizontally that can be dressed then slid into position
- ✓ Rear support for heavy equipment is required
- ✓ Field drilling is desired (3/16" aluminum facilitates field drilling)

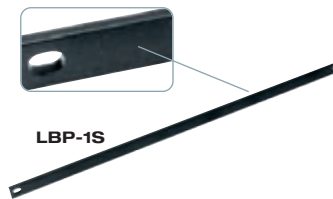

LBP-1S



### Use "L" Shape LBP-1A Lacer Bar When

- ✓ Running fixed cables horizontally
- ✓ Using hook and loop fasteners
- ✓ Rear support for equipment is required

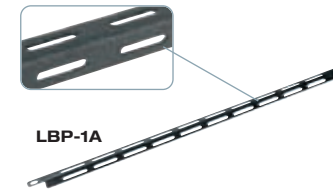

LBP-1A

### Use Round Shape LBP-1R Lacer Bar When

- ✓ When a small profile is required
- ✓ Running cable bundles horizontally that can be dressed then slid into position
- ✓ Using hook and loop fasteners

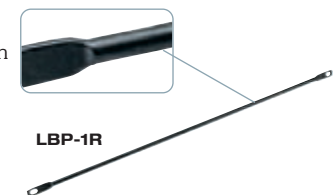

LBP-1R



### Use "L" Shape Offset LBP-2A, LBP-4A, LBP-6A or Round Shape Offset LBP-1.5, LBP-1R4 Lacer Bar When

- ✓ Rear rail is set in one position and there are various equipment depths; Able to get the lacer bar close to the rear of the unit for cable strain relief
- ✓ Managing multiple cable bundles horizontally at different depth positions
- ✓ Bend radius must be taken into consideration
- ✓ "L" shape offset lacer bars ideal for rotating racks, preventing cable bundles from sliding when rotating the rack

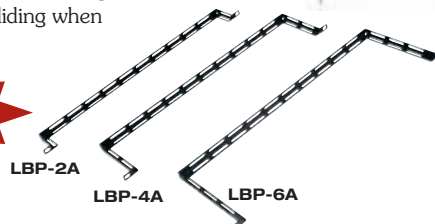

LBP-2A

LBP-4A

LBP-6A

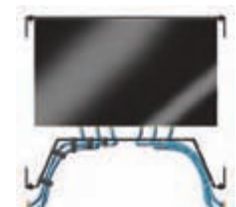

# Telescoping Lacer Bar System

## Advanced, Configurable Cable Management System Effectively Manages all Cables Within an Enclosure

LBH horizontal and LBFR front to rear lacer bars provide a configurable system for enhanced cable management with most installations. Telescoping lacer bars are adjustable to meet the specific mounting requirements of various enclosures. Unique design accepts mounting of Middle Atlantic Products vertical power strips and vertical lacer strips. LBH and LBFR lacer bars sold in packs of 2.

PATENT PENDING  
A&E SPEC. # 96-01058

| Part #      | Description  | Telescoping Range (from mounting hole to mounting hole) | Useable Depth of Rack (requires rear rackrail)                       | Pre-Pack Qty |
|-------------|--|---|--|--------------|
| LBH-1930-T  | horizontal telescoping lacer bar                                   | 19" to 30"  | -  | 2            |
| LBFR-1626-T | front to rear telescoping lacer bar                                | 16" to 26"  | 17 <sup>3</sup> / <sub>8</sub> " to 27 <sup>3</sup> / <sub>8</sub> " | 2            |
| LBFR-2036-T | front to rear telescoping lacer bar                                | 20" to 36"  | 21 <sup>1</sup> / <sub>8</sub> " to 37 <sup>3</sup> / <sub>8</sub> " | 2            |
| LBFR-3650-T | front to rear telescoping lacer bar                                | 36" to 50"  | 37 <sup>3</sup> / <sub>8</sub> " to 51 <sup>3</sup> / <sub>8</sub> " | 2            |
| LBFR-5A-16  | front to rear lacer bar (fits SAX and SSAX racks)                  | 14 <sup>1</sup> / <sub>2</sub> " only                   | 16"  | 2            |
| LBFR-5A-20  | front to rear lacer bar (fits AXS, AX-SX, AX-SXR and SLIM 5 racks) | 18 <sup>1</sup> / <sub>8</sub> " only                   | 20"  | 2            |
| LBFR-5A-26  | front to rear lacer bar (fits AXS-26 and 26" deep SLIM 5 racks)    | 24 <sup>1</sup> / <sub>8</sub> " only                   | 26"  | 2            |

## Advanced, Configurable Cable Management System Effectively Manages all Cables Within an Enclosure

LBH horizontal and LBFR front to rear lacer bars provide a configurable system for enhanced cable management with most installations. Telescoping lacer bars are adjustable to meet the specific mounting requirements of various enclosures. Unique design accepts mounting of Middle Atlantic Products vertical power strips and vertical lacer strips. LBH and LBFR lacer bars sold in packs of 2.

### Telescoping lacer bars employ unique hole patterns for cables bundled with hook and loop fasteners or wire ties

#### Manages cables from side to side

Horizontal lacer bars adjust to fit the width of a rack and can be mounted sideways for cable management, or flat to provide cable strain relief. Use in combination with front to rear lacer bars (below) to create a configurable advanced cable management system that can meet virtually any cable management need in any enclosure.

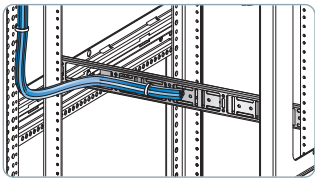

mounts vertically for cable

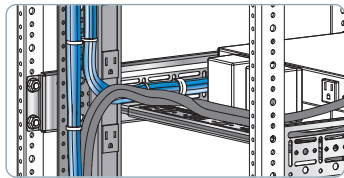

mounts flat to provide cable strain relief

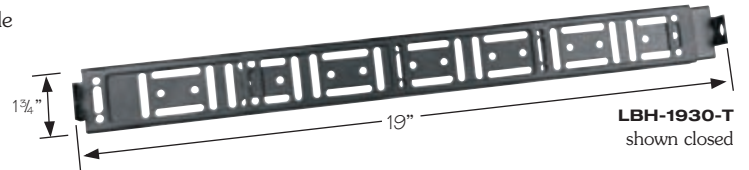

LBH-1930-T shown closed

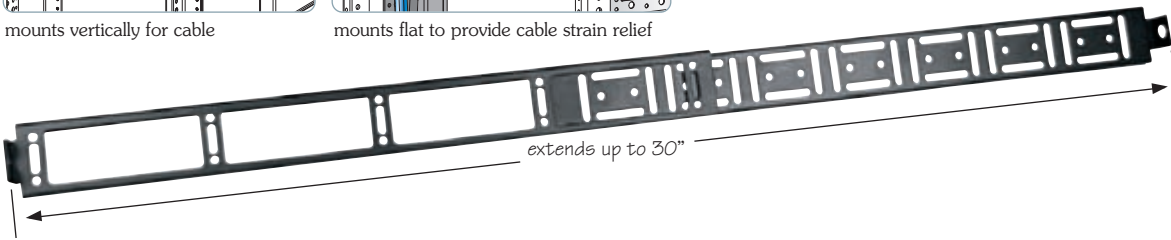

LBH-1930-T shown extended

#### Manages cables from front to rear

Front to rear fixed and telescoping lacer bars provide extensive cable management options within an enclosure. These lacer bars can also be used to mount horizontal telescoping lacer bars, vertical power strips, and LACE vertical lacer strips (can also mount to LACE).

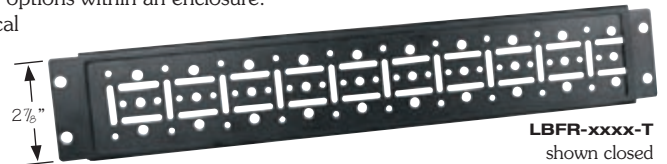
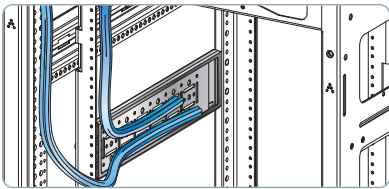

LBFR-xxxx-T shown closed



LBFR-xxxx-T shown extended

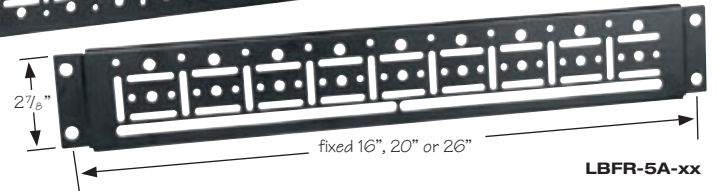

LBFR-5A-xx

# Telescoping Lacer Bar System

## LBH and LBFR Series

Front to rear lacer bars accept a variety of Middle Atlantic Products power strips, see pgs. 64-79.

**LBH-1930-T** shown mounted between two LBFR Series telescoping lacer bars

**LACE**

**PDT Series Configurable Thin Power Strip**

Versatile Mounting Configurations:

- ✓ Inside flange of rackrail
- ✓ Rackrail brackets
- ✓ LACE vertical lacer bars
- ✓ Also mounts front to rear on LACE vertical lacer strips

**LBFR-xxxx-T**

Front to rear lacer bars are engineered to accept mounting of LACE vertical lacer strips (see pg. 111) and can help manage cables horizontally and vertically throughout a rack.

LBH-1930-T can be used for cable strain relief behind units when mounted flat.

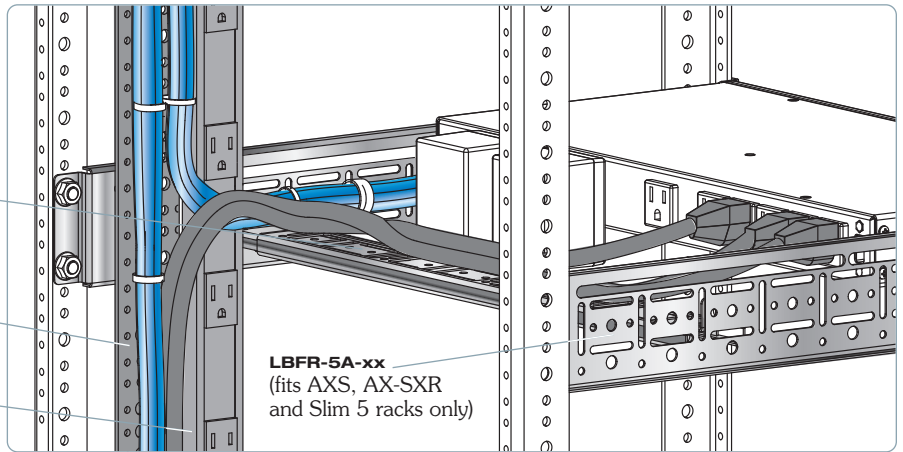

## LBFR Series

LBFR-xxxx-T telescoping front to rear lacer bars adjust to fit enclosure depth and attach to rackrail.

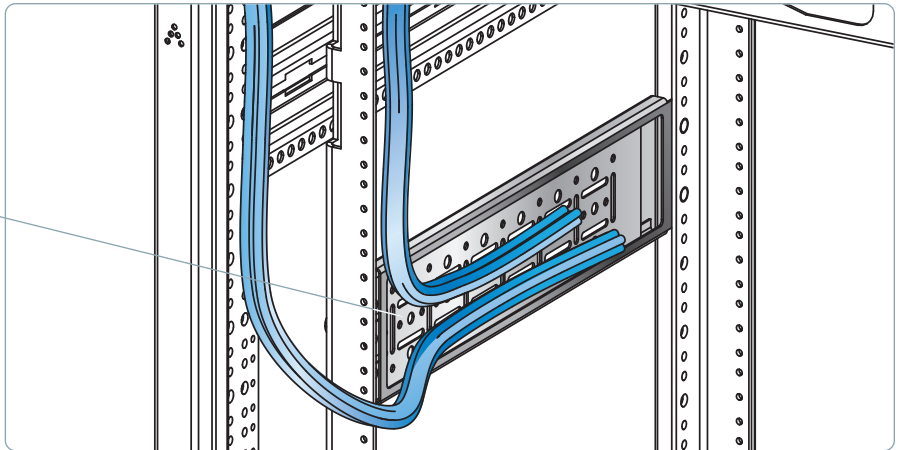

## LBH Series

LBH-1930-T telescoping lacer bar adjusts to fit enclosure widths from 19" to 30" and allows for horizontal cable management. It can also be mounted flat to provide cable strain relief.

**LBH-1930-T**

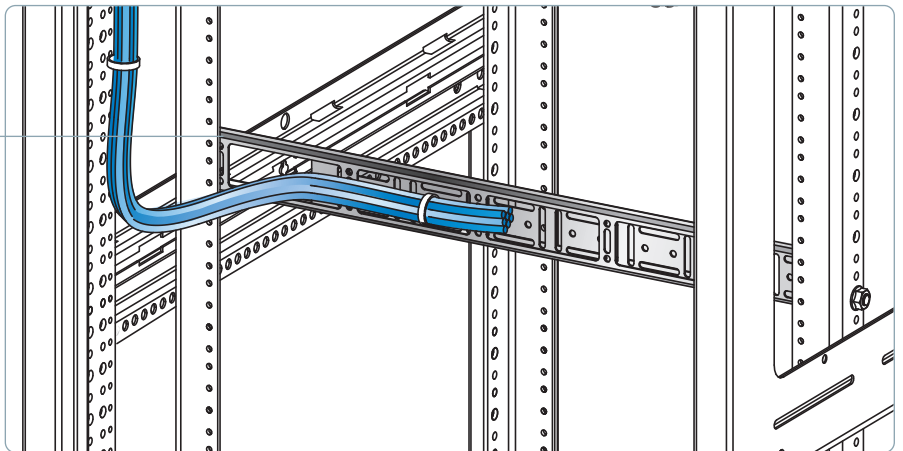

# Horizontal Lacer Bars

TIA/EIA COMPLIANT

## Horizontal Lacer Bars

The economical and effective way to manage cable horizontally. Made from 1/4" diameter rod with flattened ends (model LBP-1R, LBP-1.5 and LBP-1R4) or 3/16" thick aluminum (model LBP-1S), and finished in a black powder coat. Model LBP-1R4 features a 4" offset and model LBP-1.5 features a 1 1/2" offset for easy viewing of cable identification. Model LBP-1A, LBP-2A, LBP-4A and LBP-6A feature a formed "L" shape, generous cable tie slots, a special coating to protect cable, and are offered in straight and 2", 4" and 6" offset models, respectively. All lacer bars sold in packs of 10.

| Part #    | Style                            | Pre-Pack Qty | Panel Width |
|-----------|----------------------------------|--------------|-------------|
| LBP-1R    | 10 pack, round rod               | 10           | 19"         |
| LBP-1.5   | 10 pack, 1 1/2" offset round rod | 10           | 19"         |
| LBP-1R4   | 10 pack, 4" offset round rod     | 10           | 19"         |
| LBP-1S    | 10 pack, rectangular bar         | 10           | 19"         |
| LBP-1A    | 10 pack, "L" bar                 | 10           | 19"         |
| LBP-1A-23 | 10 pack, "L" bar                 | 10           | 23"         |
| LBP-2A    | 10 pack, "L" bar 2" offset       | 10           | 19"         |
| LBP-4A    | 10 pack, "L" bar 4" offset       | 10           | 19"         |
| LBP-6A    | 10 pack, "L" bar 6" offset       | 10           | 19"         |



an example of proper cable management using the LBP-1A lacer bar, provided by Dave Zastrow - Multimedia Solutions

### LBP-1R

Use the LBP-1R round lacer bar when a small profile is required and for lacing small horizontal cable runs.



### LBP-1R4 and LBP-1.5

Use the LBP-1.5 and LBP-1R4 when lacing cables off the rear of equipment, patch panels and other components to relieve cable stress from the connections. The LBP-1.5 features a 1 1/2" offset and the LBP-1R4 has a 4" offset. Choose the appropriate lacer bar based on the distance from the rear of equipment to the rackrail.



### LBP-1S

Use the LBP-1S 3/16" thick aluminum lacer bar when lacing cables vertically or horizontally. Aluminum construction provides the ability to drill holes to attach tie saddles, mount electrical boxes, etc. This lacer bar can also be used to support the rear of equipment.



### LBP-1A, LBP-2A, LBP-4A and LBP-6A

Use "L" shaped lacer bars when lacing cables vertically or horizontally; recommended for larger runs of cable. The LBP-2A, LBP-4A and LBP-6A have a 2", 4" and 6" offset, respectively. Choose the appropriate lacer bar based on the distance from the rear of equipment to the rackrail.

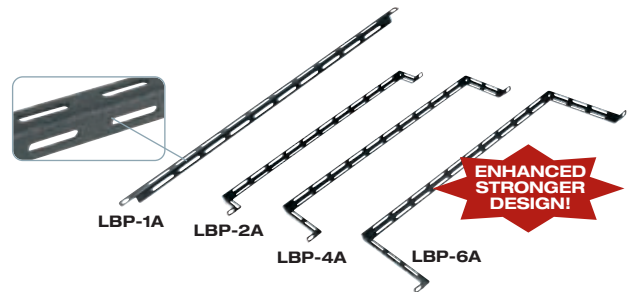

### LBP-LTF and UP1P Horizontal Lacer Panel

Use the LBP-LTF and UP1P when lacing large amounts of cable or mounting devices. Two rackspace high, the LBP-LTF features a large flange, numerous cable tie points and more surface for mounting.

| Part #  | Style               | Pre-Pack Qty | Panel Width |
|---------|---------------------|--------------|-------------|
| UP1P    | 1 space lacer panel | 10           | 19"         |
| LBP-LTF | 2 space lacer panel | 10           | 19"         |



# Vertical Lacer Strips And Cable Managers

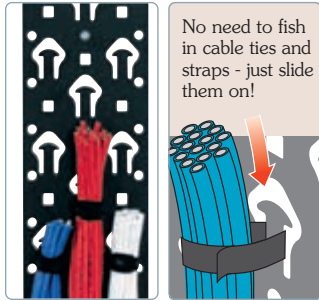

LACE-44-OWP

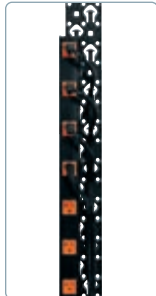

LACE-44-OP shown w/power



LACE-44-OP shown w/cable



LACE-44-1P



LACE-44-1SP

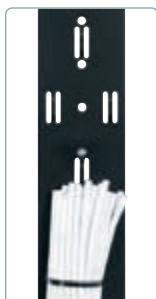

LACE-44-LP



LACE-P

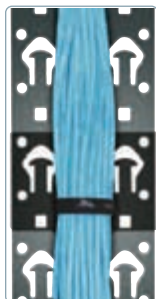

ASP-OWP

## Vertical Lacer Strips

Perforated steel lacer strips mount vertically to rackrail brackets and provide many locations for securing cable bundles. Lacer strips can be cut down easily to smaller sizes. LACE-OWP and LACE-OP strips with tie posts for sliding on pre-wrapped cable bundles using 3/4" hook-and-loop straps or cable ties.

Some lacer strips also accept cage nuts or mounting of select power strips for increased versatility. All strips sold in packs of 6.



**NEW**

**NEW**

**NEW**

**NEW**

**NEW**

| Part #                  | Description                                       | Qty | Compatible Cable Mgmt Options <b>NEW</b> |          |      |           |                     |
|-------------------------|---|-----|--|----------|------|-----------|---------------------|
|                         |   |     | Cable Ties                               | TSW-15   | TW12 | Cage Nuts | Anti-Slip Cable Pad |
| LACE-44-OWP*            | 4 3/4" width, 44 space w/ tie posts               | 6   | ✓  | ✓        | ✓    | ✓         | ✓                   |
| LACE-40-OWP*            | 4 3/4" width, 40 space w/ tie posts               | 6   | ✓  | ✓        | ✓    | ✓         | ✓                   |
| LACE-37-OWP*            | 4 3/4" width, 37 space w/ tie posts               | 6   | ✓  | ✓        | ✓    | ✓         | ✓                   |
| <b>NEW</b> LACE-23-OWP* | 4 3/4" width, 23 space w/ tie posts               | 6   | ✓  | ✓        | ✓    | ✓         | ✓                   |
| <b>NEW</b> LACE-13-OWP* | 4 3/4" width, 13 space w/ tie posts               | 6   | ✓  | ✓        | ✓    | ✓         | ✓                   |
| LACE-44-OP*             | 3 3/4" width, 44 space w/ tie posts               | 6   | ✓  | ✓        | ✓    | ✓         | -                   |
| LACE-40-OP*             | 3 3/4" width, 40 space w/ tie posts               | 6   | ✓  | ✓        | ✓    | ✓         | -                   |
| LACE-37-OP*             | 3 3/4" width, 37 space w/ tie posts               | 6   | ✓  | ✓        | ✓    | ✓         | -                   |
| <b>NEW</b> LACE-23-OP*  | 3 3/4" width, 23 space w/ tie posts               | 6   | ✓  | ✓        | ✓    | ✓         | -                   |
| <b>NEW</b> LACE-13-OP*  | 3 3/4" width, 13 space w/ tie posts               | 6   | ✓  | ✓        | ✓    | ✓         | -                   |
| LACE-44LP               | 3 1/2" width, 44 space w/ raised lances           | 6   | ✓  | -        | ✓    | -         | -                   |
| LACE-37LP               | 3 1/2" width, 37 space w/ raised lances           | 6   | ✓  | -        | ✓    | -         | -                   |
| LACE-P*                 | 2" width, 45 space, 1/8" thick w/ round holes     | 6   | ✓  | ✓        | -    | -         | -                   |
| LACE-37P*               | 2" width, 37 space, 1/8" thick w/ round holes     | 6   | ✓  | ✓        | -    | -         | -                   |
| <b>NEW</b> LACE-13P*    | 2" width, 13 space, 1/8" thick w/ round holes     | 6   | ✓  | ✓        | -    | -         | -                   |
| LACE-44-1SP             | 1" width, 44 space w/10 pre-installed tie saddles | 6   | ✓  | included | ✓    | -         | -                   |
| LACE-37-1SP             | 1" width, 37 space w/10 pre-installed tie saddles | 6   | ✓  | included | ✓    | -         | -                   |
| LACE-44-1P*             | 1" width, 44 space tapped for tie saddles         | 6   | ✓  | ✓        | -    | -         | -                   |
| LACE-37-1P*             | 1" width, 37 space tapped for tie saddles         | 6   | ✓  | ✓        | -    | -         | -                   |



Velcro® cable management straps available, see pg. 112

## Anti-Slip Cable Pad **NEW**

- Innovative material mounts to OWP Series Lace and reduces weight of cables and stops the need to over tighten cable fasteners to the point of deformation
- Heavy cable bundles are kept in place, reducing strain on connections and tie points with the anti-slip cable pad's patented permanent high friction surface
- Supports up to 40% of the weight of the cable bundles
- Reduces the occurrence of Return Loss by avoiding over-tightening hook and loop straps – the anti-slip cable pad keeps cable bundles secure

| Part #    | Qty |
|-----------|-----|
| ASP-OWP   | 4   |
| ASP-OWP-6 | 24  |



ASP-OWP

## Rackmount Cable Tray

Handy horizontal cable tray mounts on any 19" rack or cabinet and neatly routes cable bundles from side to side. Turn-downs on sides help maintain the required cable bend radius. Finished in a durable black powder coat.

| Part # | Racking Height   |
|--------|------------------|
| HCT-1  | 1 3/4" (1 space) |
| HCT-2  | 3 1/2" (2 space) |



HCT-1

## Utility/Lace Panel

Give the drill a rest - these panels are pre-punched with plenty of slots. This economical panel is capable of lacing cables as well as mounting everything from electrical boxes to power strips. 16-gauge flanged steel construction, black powder coat finish, occupies 1 rackspace (1 3/4").

| Part # | Racking Height   | Qty |
|--------|------------------|-----|
| UP1    | 1 3/4" (1 space) | 1   |
| UP1P   | 1 3/4" (1 space) | 10  |



UP1

## Brush Grommet Panel

The brush grommet panel provides a clean, organized cable entry method when mounted above any work surface. Features a built-in cable management tray. Available in one and two space versions. Two space brush grommet fits in opening on all MW Series top options.

| Part # | Racking Height   |
|--------|------------------|
| BR1    | 1 3/4" (1 space) |
| BR2    | 3 1/2" (2 space) |



BR2 shown in top option



BR1



BR2

## Cable Tie Saddles

Accommodates cable ties and hook & loop straps up to 3/4" wide, including the TW12 cable management strap. Mounts to wall or specified LACE bars. Sold in packs of 15 and includes mounting hardware.

| Part # | Description                  | Qty |
|--------|------------------------------|-----|
| TSW-15 | cable tie saddles & hardware | 15  |



TSW-15

## Cable Management Straps

Fasten cable bundles securely while maintaining the integrity of the cable. TW12 reusable cable management straps are made from Velcro® and are perfect for managing cables that are sensitive to strain. These straps are 8" long and are sold in 12 piece packs.

| Part # | Description                     | Qty |
|--------|---------------------------------|-----|
| TW12   | 8" cable/wire management straps | 12  |

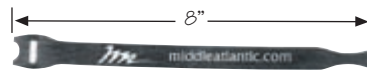

TW12

## Protective Grommet

Place this flexible grommet material around openings and knockouts for additional cable protection. Fits any material up to 1/8" thick. Includes 30 ft. of black grommet.

| Part # | Description      |
|--------|------------------|
| GR-30  | grommet, 30 feet |

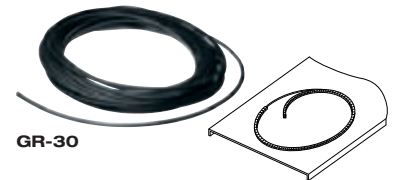

GR-30

## Grommets

Grommets protect cables, fit ERK, SR, WR and MR-1945-24 Series enclosure knockouts and can be used on any 4" trade-size electrical knockout or used on 4 1/2" fan knockouts on Middle Atlantic Products top options. Allows for ganging without using expensive electrical fittings. GK-4G gland grommet blocks dust and helps control airflow.

| Part # | Description      | Qty |
|--------|------------------|-----|
| GK4    | 4" grommet ring  | 4   |
| GK-4G  | 4" gland grommet | 4   |

GK4 mounted in ganged ERKs



GK-4G shown mounted on MW-4FT top option



GK4





# Horizontal Cable Managers



HCM-1

HCM-1V



HCM-1D

HCM-1DV



HCM-2D

HCM-2DV



D-RING

TIA/EIA COMPLIANT  
A&E SPEC. # 96-337

## Horizontal Cable Managers

Organize patch cords and maintain a required bend radius. Available in a wide variety of styles to suit any application. The D-Ring provides a creative solution for adding individual D-Rings to a rack or on a wall using appropriate fasteners. Select styles also available in 23" panel widths. For optimal performance, do not exceed a 50% fill rate when passing cables through cable rings. Constructed from 16-gauge steel, and finished in a durable black powder coat.

| Part #   | Description                                      | Panel Width | Cable Rings Fill Area  | End Rings Fill Area    |
|----------|--|-------------|------------------------|------------------------|
| HCM-1    | 1 3/4" (1 sp.) "micro-clip" style                | 19"         | 7/8 in. <sup>2</sup>   | -                      |
| HCM-1V   | 1 3/4" (1 sp.) "micro-clip" style, w/end D-Rings | 19"         | 7/8 in. <sup>2</sup>   | 7 1/2 in. <sup>2</sup> |
| HCM-1D   | 1 3/4" (1 sp.) "D-Ring" style                    | 19"         | 3 1/8 in. <sup>2</sup> | -                      |
| HCM1D-23 | 1 3/4" (1 sp.) "D-Ring" style                    | 23"         | 6 1/4 in. <sup>2</sup> | -                      |
| HCM-1DV  | 1 3/4" (1 sp.) "D-Ring" style, w/end D-Rings     | 19"         | 3 1/8 in. <sup>2</sup> | 7 1/2 in. <sup>2</sup> |
| HCM-2D   | 3 1/2" (2 sp.) "D-Ring" style                    | 19"         | 7 1/2 in. <sup>2</sup> | -                      |
| HCM2D-23 | 3 1/2" (2 sp.) "D-Ring" style                    | 23"         | 7 1/2 in. <sup>2</sup> | -                      |
| HCM-2DV  | 3 1/2" (2 sp.) "D-Ring" style, w/ end D-Rings    | 19"         | 7 1/2 in. <sup>2</sup> | 7 1/2 in. <sup>2</sup> |
| HCM-1DR  | 1 3/4" (1 sp.) "D-Ring", front and rear          | 19"         | 6 1/4 in. <sup>2</sup> | -                      |
| HCM-2DR  | 3 1/2" (2 sp.) "D-Ring", front and rear          | 19"         | 15 in. <sup>2</sup>    | -                      |
| D-RING   | wall mount/rackmount "D-Ring"                    | -           | 7 1/2 in. <sup>2</sup> | -                      |

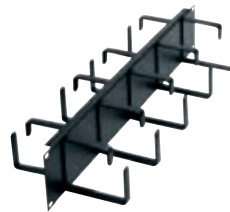

HCM-2DR



HCM-1DR

HHCM-2 cable pass-through and hinged front panel for a clean professional installation



A&E SPEC. # 96-01003

## Hinged Horizontal Cable Manager

Conceal patch cables while providing cable strain relief with the hinged horizontal cable managers. These 19" cable managers provide a strong, attractive method for organizing patch cords and maintaining the required bend radius. The latching hinged front panel conceals cables dressed between components and cable chases. Ample cable pass-throughs provided for dressing cables above, below, to the sides and behind the cable manager. Finished in a durable black powder coat.

| Part # | Racking Height   | Depth  |
|--------|------------------|--------|
| HHCM-1 | 1 3/4" (1 space) | 3 5/8" |
| HHCM-2 | 3 1/2" (2 space) | 3 5/8" |

# Cable Ladders



A&E SPEC.  
# 96-986

A complete line of 12" wide, fully welded cable ladders. Cable ladder sections ship fully boxed, which minimizes product damage and simplifies shipping and storage. Highly durable finish consists of 2 layers of black powder coat and is exceptionally scratch resistant. Compatible with most popular brands and accessories of cable ladders, these will work on both new and retrofit installations.

**MW-LA** cable ladder top option available for DRK, MRK, WRK, VRK and VMRK Series enclosures.



### LADDER SECTIONS

| Part #     | Qty | Weight Capacity | Description                                 |
|------------|-----|-----------------|---|
| CLB-6      | 1   | 187 lbs.        | 6' long x 12" wide straight section, black  |
| CLB-6-12   | 12  | 187 lbs.        | 6' long x 12" wide straight section, black  |
| CLB-10     | 1   | 187 lbs.        | 10' long x 12" wide straight section, black |
| CLB-10-12  | 12  | 187 lbs.        | 10' long x 12" wide straight section, black |
| CLB-90HB   | 1   | 187 lbs.        | 90° horizontal bend, 12" wide, black        |
| CLB-90HB-4 | 4   | 187 lbs.        | 90° horizontal bend, 12" wide, black        |
| CLB-VI90   | 1   | 187 lbs.        | 90° vertical inside bend, 12" wide, black   |
| CLB-VI90-4 | 4   | 187 lbs.        | 90° vertical inside bend, 12" wide, black   |
| CLB-VO90   | 1   | 187 lbs.        | 90° vertical outside bend, 12" wide, black  |
| CLB-VO90-4 | 4   | 187 lbs.        | 90° vertical outside bend, 12" wide, black  |

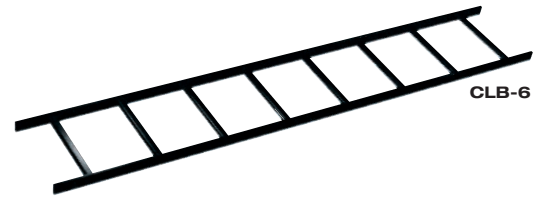

CLB-6



CLB-90HB

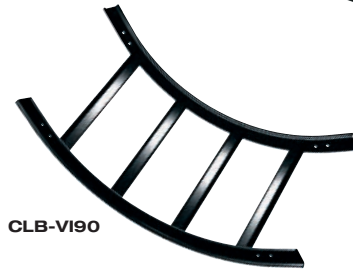

CLB-VI90



CLB-VO90

### JUNCTION AND SPLICE HARDWARE

| Part #     | Qty     | Description                           |
|------------|---------|---------------------------------------|
| CLH-ADJH   | 1 pair  | adjustable horizontal splice hardware |
| CLH-ADJH-6 | 6 pairs | adjustable horizontal splice hardware |
| CLH-RSJ    | 1 pair  | ladder end splice hardware            |
| CLH-RSJ-6  | 6 pairs | ladder end splice hardware            |
| CLH-HTS    | 1 pair  | horizontal 90° tee splice hardware    |
| CLH-HTS-6  | 6 pairs | horizontal 90° tee splice hardware    |
| CLH-ADJT   | 1 pair  | adjustable ladder end splice hardware |
| CLH-ADJT-6 | 6 pairs | adjustable ladder end splice hardware |
| CLH-90T    | 1 pair  | adjustable 90° tee splice hardware    |
| CLH-90T-6  | 6 pairs | adjustable 90° tee splice hardware    |

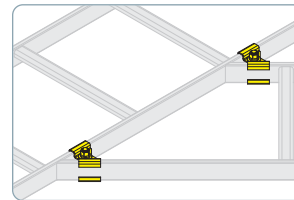

CLH-ADJH

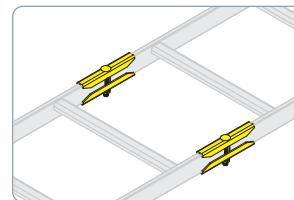

CLH-RSJ

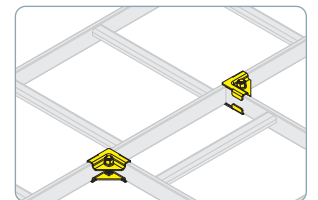

CLH-HTS

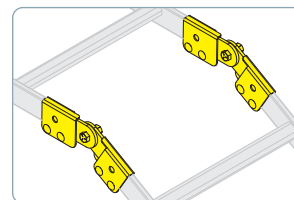

CLH-ADJT

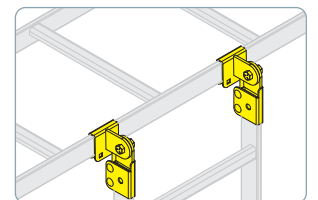

CLH-90T



# Cable Ladders

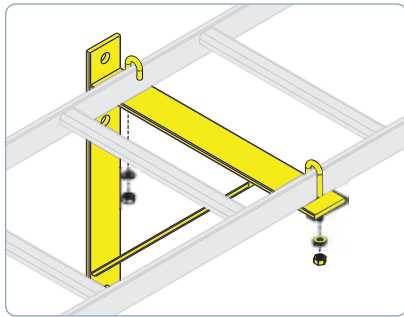

**CLB-TSB**

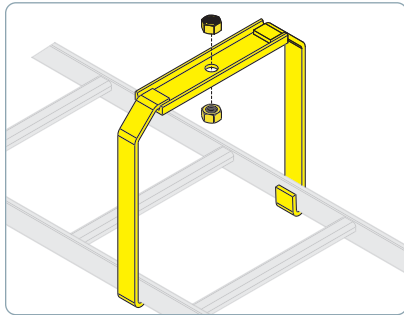

**CLB-CSB**

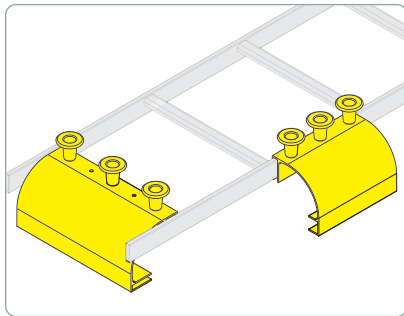

**CLH-ED11 and CLH-SD8**

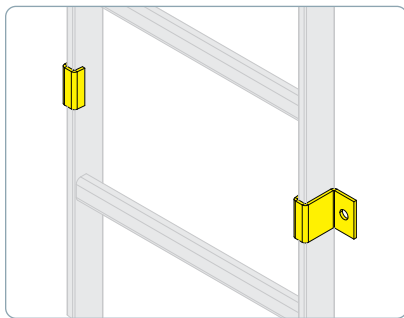

**CLH-RWC**

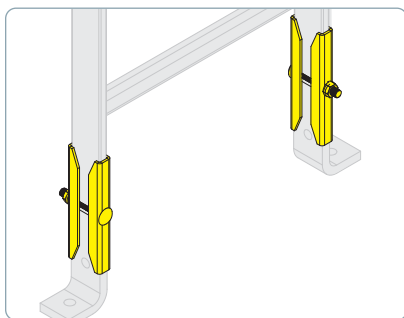

**CLH-RES**

## Wall and Ceiling Mount Kits

| Part #       | Qty       | Description   |
|--------------|-----------|---|
| CLB-TSB      | 1         | triangle wall support bracket                                       |
| CLB-TSB-6    | 6         | triangle wall support bracket                                       |
| CLB-CSB      | 1         | ladder center support bracket                                       |
| CLB-CSB-6    | 6         | ladder center support bracket                                       |
| CLH-ED11     | 1         | cable ladder end drop, 3 spools included                            |
| CLH-ED11-4   | 4         | cable ladder end drop, 3 spools included                            |
| CLH-SD8      | 1         | cable ladder side drop, 3 spools included                           |
| CLH-SD8-4    | 4         | cable ladder side drop, 3 spools included                           |
| CLH-SPOOL-10 | 10        | additional spools for cable ladder drops or wall mounting           |
| CLH-5/8CHK   | 1 pair    | adjustable 90° tee splice hardware                                  |
| CLH-5/8CHK-6 | 6 pairs   | slotted ladder support hardware w/ hang kit (threadedrod not incl.) |
| CLH-RES      | 1 pair    | ladder end support hardware   |
| CLH-RES-6    | 6 pairs   | ladder end support hardware   |
| CLH-RWC      | 1 pair    | ladder wall clamp   |
| CLH-RWC-6    | 6 pairs   | ladder wall clamp   |
| CLH-WRS      | 1         | ladder wall support hardware  |
| CLH-WRS-6    | 6         | ladder wall support hardware  |
| CLH-EC-12    | 12 pieces | ladder end caps   |
| CLH-JBOLT    | 1 pair    | j-bolts only  |
| CL-GK        | 1         | cable ladder bonding kit  |

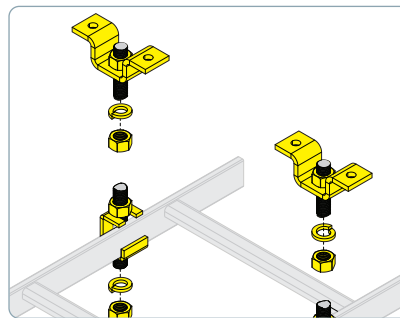

**CLH-5/8CHK**

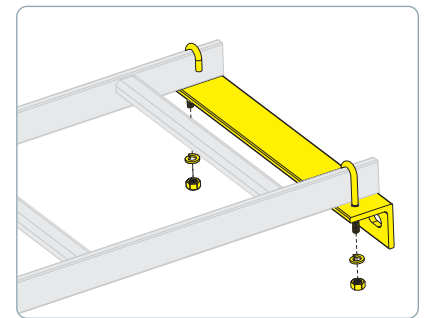

**CLH-WRS**

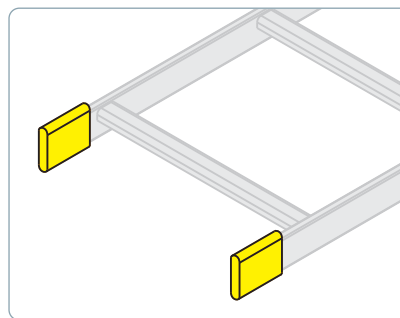

**CLH-EC-12**

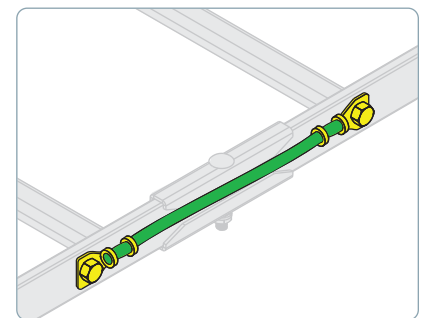

**CL-GK**

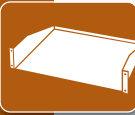

# RSH Series Custom Rackmounts

## The Professional's Choice for Mounting and Trimming Non-Rackmount Components

With the innovative RSH custom rackmounts, virtually any component can be installed in a standard 19" enclosure without modification. Custom cut to provide a perfect opening for the face of the component that is being mounted, each RSH unit provides a neatly-trimmed installation with a perfect fit and no gaps. With accurate details on over 8,500 components in our measured unit database, chances are we have the component needed on file.

Unit assembles easily in minutes and includes rear brackets to prevent the mounted component from sliding back. Fully ventilated ears and bottom promote cooling. Depending on the needs of the installation, the units can be ordered with a black textured finish (model RSH4S), a silver brushed and anodized finish (model RSH4C) or a black brushed and anodized finish (model RSH4A). Bottom depths are automatically provided in 11½", 14", 15½", 17½", or 20½" styles. Custom rackmounts will accept any component up to 17¾" wide. Individual fascias (less rack ears and shelf bottom) are also available in a black textured finish (model SFACE), silver brushed and anodized finish (model CFACE) or a black brushed and anodized finish (model AFACE). LCD rackmounts also available to mount most LCD monitors with up to a 17" screen size or with a maximum width of 17⅜". NOTE: custom rackshelf height is specified at the factory based on physical restrictions. Visit [middleatlantic.com](http://middleatlantic.com) to find heights on all measured components.

TIA/EIA COMPLIANT cUL US LISTED

A&E SPEC. # 96-034 (COMPONENT)

A&E SPEC. # 96-999 (LCD)

| Part # & Finish                      | Matching Finish                                     | Pg. |
|--------------------------------------|---|-----|
| RSH4A<br>black brushed and anodized  | TA Trim Strip                                       | 120 |
|                                      | Media Holders (CD, VHS, VHS-L, CD-1, LP, DVD)       | 120 |
|                                      | D Series Rack Drawers                               | 121 |
|                                      | QFP Quiet Fan Panels                                | 82  |
|                                      | FP Fan Panels                                       | 82  |
|                                      | BL, HBL Blank Panels                                | 130 |
|                                      | VTP, EVTA Ventilation Panels                        | 131 |
| RSH4C<br>silver brushed and anodized | TC Trim Strip                                       | 120 |
|                                      | Media Holders (CCD, CVHS, CVHS-L, CCD-1, CLP, CDVD) | 120 |
|                                      | DC Series Rack Drawers                              | 121 |
|                                      | CHBL Blank Panels                                   | 130 |
|                                      | CVTP, EVTC Ventilation Panels                       | 131 |
| RSH4S<br>black textured powder coat  | TS Trim Strip                                       | 120 |
|                                      | Media Holders (TCD, TVHS)                           | 120 |
|                                      | TD Series Rack Drawers                              | 121 |
|                                      | QTFP Quiet Fan Panels                               | 82  |
|                                      | TFP Fan Panels                                      | 82  |
|                                      | SB Blank Panels                                     | 130 |
|                                      | VT, EVT Ventilation Panels                          | 131 |



Installation by Home Systems



RSH custom rackmount shown with component installed



RSH shown with silver brushed and anodized finish

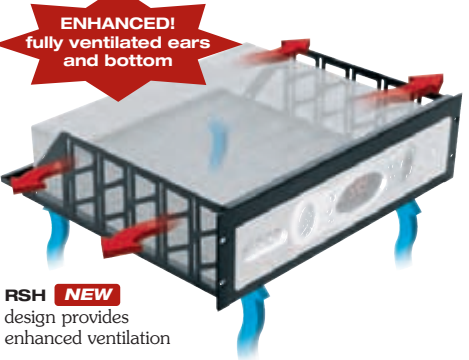

**ENHANCED!** fully ventilated ears and bottom

RSH **NEW** design provides enhanced ventilation

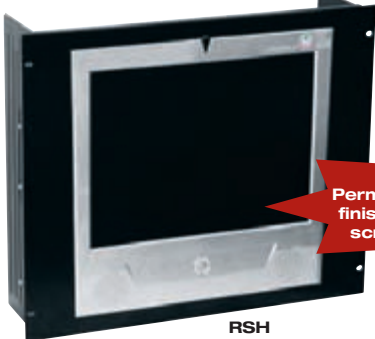

**ENHANCED!** Perma-Black anodized finish provides better scratch resistance

RSH LCD mounts



**MIGHTY STUD** makes installation easier!



**NEW** PD-815SC-PBSH rear mount power option available

# RSH Series Custom Rackshelves

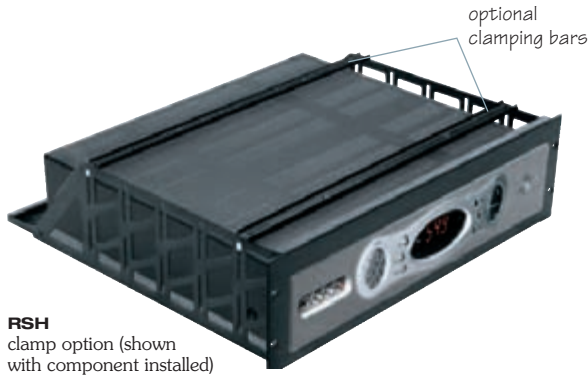

**RSH**  
clamp option (shown  
with component installed)

## RSH Clamp Options

When dealing with mobile applications or seismic issues, use the RSH clamp option to secure components to the shelf. Clamping bars have rubber bumpers to maintain a tight grip while keeping components scratch-free.

| Part # | Finish                          |
|--------|---------------------------------|
| RSH4A  | black brushed and anodized      |
| RSH4C  | silver brushed and anodized     |
| RSH4S  | black textured powder coat      |
| -C     | clamp kit for all above         |
| AFACE  | black anodized face plate only  |
| CFACE  | silver anodized face plate only |
| SFACE  | black textured face plate only  |



## Ordering Instructions

Visit [middleatlantic.com](http://middleatlantic.com) to see if the dimensions for the component to be rackmounted already exist among the over 8,500 on file. If we don't have the dimensions, we strongly suggest that you insure the component and ship it to us via UPS so that we may accurately measure it. We will ship the component back to you insured, the next day. The complete custom rackmount will follow within the next 2 business days.

A second ordering option for custom mounting components with dimensions we don't have on file is to fax us the measurements using the form on this page. The W, H, and F dimensions shown in the illustration **MUST** be accurate within  $\frac{1}{32}$ ", depth can be within  $\frac{1}{8}$ ". The use of dimensions provided in the component's owner's manual are **NOT** recommended. Please measure carefully as RSH units are custom-made and non-returnable.



installation by Home Systems



Micro Fiber Cleaning  
Cloths keep anodized  
finishes clean,  
see pg. 133

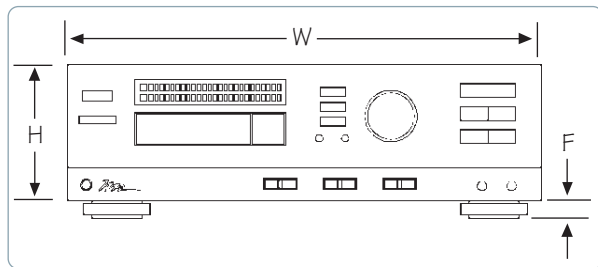

dimensions (must be within  $\frac{1}{32}$ "



brushed and anodized blank panels  
complement RSH Series custom rackshelves,  
see pg. 130

If we need dimensions please photocopy, fill in and fax to 973-839-1076

|                |   |
|----------------|---|
| company name:  | phone:  |
| contact name:  | fax:  |
| p.o.#:         | <input type="checkbox"/> Black brushed and anodized finish<br><input type="checkbox"/> Silver brushed and anodized finish<br><input type="checkbox"/> Black textured finish |
| make:          | model:  |
| W=face width:  | H=face height:  |
| F=foot height: | Depth:  |

Please visit our website for a complete list of measured components.

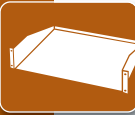

# Rackmount LCD, Keyboard And Touchpad, With KVM Switch

## Rackmount LCD, Keyboard and Touchpad, **NEW** with KVM Switch

The Rackmount LCD Keyboard and Touchpad can be installed wherever rackmount control and system monitoring is required and can be used for a wide range of applications including network security and system performance monitoring. The 17" LCD monitor is capable of supporting 1280 x 1024 screen resolution, and is available with 8 or 16 port KVM switch. With its space saving, single rackspace design and dual-slide functionality, the rackmount LCD monitor can reside in the open position for system monitoring while the keyboard is in the closed position.

These units feature rear articulating cable carriers for strain relief and a bright active matrix LCD display for ergonomic viewing of monitoring applications. Standard 105 key keyboard with integrated touchpad. 6' connector cable included, and auto detects 120V or 240V power. This unit has a range of front to rear mounting of 18¾" to 30" (overall depth is 24.5", this unit will extend through the back of shallower racks). UL Listed in the US and Canada. Works internationally with customer supplied cord.

TIA/EIA COMPLIANT  
UL LISTED

A&E SPEC.  
# 96-01025

**REDESIGNED**

**EASY ONE PERSON MOUNTING!**



**RM-KB-LCD17X8KVM**

**NOW AVAILABLE WITH KVM SWITCH!**

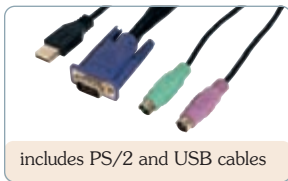

| Part #                       | Screen Size                   | Resolution  | Racking Height | KVM Switch | PS/2/USB Cords Included |
|------------------------------|-------------------------------|-------------|----------------|------------|-------------------------|
| RM-KB-LCD17                  | 17"                           | 1280 x 1024 | 1¾" (1 space)  | -          | -                       |
| <b>NEW</b> RM-KB-LCD17X8KVM  | 17"                           | 1280 x 1024 | 1¾" (1 space)  | 8 port     | 4                       |
| <b>NEW</b> RM-KB-LCD17X16KVM | 17"                           | 1280 x 1024 | 1¾" (1 space)  | 16 port    | 8                       |
| <b>NEW</b> PS2/USB-4C        | PS/2 and USB cables, 4 pieces |             |                |            |                         |



# LCD And Keyboard Rackmounts



**RSH**  
LCD mounts



accommodates most LCD screens up to 17" in size, or with a maximum width of 17<sup>3/8</sup>"

(rear)

hinged arm for cable management

includes 12' keyboard & trackball cable!



**RM-KB**

adjustable 17"-25"



**KB-SS**

adjustable 17"-25"

## RSH Series Custom Mounts for LCD Monitors

RSH Series custom rackshelves are custom-cut to provide an attractive, secure mount for most LCD screens up to 19" in size or with a maximum width of 17<sup>3/8</sup>". See pg. 116 for more information on custom rackmounts, or visit [middleatlantic.com](http://middleatlantic.com) to see if we already have the dimensions for the LCD that is being rackmounted.

| Part #* | Finish                      |
|---------|-----------------------------|
| RSH4A   | black brushed and anodized  |
| RSH4C   | silver brushed and anodized |
| RSH4S   | black textured powder coat  |

\*When ordering, specify make and model of LCD to be mounted.

TIA/EIA COMPLIANT  
UL LISTED

A&E SPEC.  
# 96-999

## Rackmount Computer Keyboard With Sliding Shelf

Model RM-KB rackmount computer keyboard system occupies 1<sup>3/4</sup>" (1 space) and includes a high-quality full 101 key AT style keyboard, with trackball and padded wrist-rests. Articulating arm provides effective cable management. Comes complete with 12' keyboard and trackball cables including PS/2 adaptor for both, and USB adapter. Finished in a durable black powder coat.

| Part # | Description                 | Racking Height               |
|--------|-----------------------------|------------------------------|
| RM-KB  | rackmount computer keyboard | 1 <sup>3/4</sup> " (1 space) |

TIA/EIA COMPLIANT

## Keyboard Sliding Shelf

Accommodates keyboards with a maximum width of 15<sup>15/16</sup>" and depth of 9<sup>3/8</sup>". Articulating arm provides effective cable management.

| Part # | Description             | Racking Height               |
|--------|-------------------------|------------------------------|
| KB-SS  | key board sliding shelf | 1 <sup>3/4</sup> " (1 space) |

TIA/EIA COMPLIANT

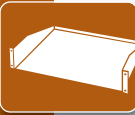

# Media Storage/Trim Strips

## Front-Loading Media Holders

Store CDs, DVDs, VHS tapes, laser discs and other recorded media in our rackmount media holders. Partitioned to prevent the contents from tipping, each model features a 16-gauge flanged aluminum face and has a black brushed and anodized or silver brushed and anodized finish. Select models are available with a textured black powder coat finish. All stored media protrudes 3/8" to allow quick retrieval.

| Silver Anodized Part # | Black Anodized Part # | Black Textured Part # | Fits  | Racking Height    | Depth    |
|------------------------|-----------------------|-----------------------|---|-------------------|----------|
| CCD                    | CD                    | TCD                   | 40 compact discs, SA-CD   | 7" (4 space)      | 5 3/4"   |
| CCD-1                  | CD-1                  | -                     | 6 CDs   | 1 3/4" (1 space)  | 5 1/2"   |
| CVHS                   | VHS                   | TVHS                  | 14 VHS tapes in regular case  | 8 3/4" (5 space)  | 4 13/16" |
| CVHS-L                 | VHS-L                 | -                     | 13 VHS in large padded case   | 10 1/2" (6 space) | 5 9/16"  |
| CLP                    | LP                    | -                     | laser discs, LPs, binders   | 14" (8 space)     | 12 9/10" |
| CDVD                   | DVD                   | -                     | 28 DVDs; PS3, Xbox 360™, Wii™ games; Blu-ray, HD-DVD, DVD-Audio media | 8 3/4" (5 space)  | 5 1/2"   |



CD



CD-1

DVD holder accommodates DVDs; PS3, Xbox 360™, Wii™ games; Blu-ray, HD-DVD, DVD-Audio media



LP



VHS



VHS-L



CDVD

## Trim Strips

As a final aesthetic complement to any installation, add our finishing trim strips. A quick, clean and effective method of covering rack screws once the job is complete. Each channel-shaped trim strip measures 45 spaces (78 3/4" long), and features internal grooves that fit into the supplied snap washers. Offered in black brushed and anodized, silver brushed and anodized or black powder coat finish, trim strips are cut easily to size with a hacksaw. Sold in individual strips.

| Part # | Finish                      | Includes  |
|--------|-----------------------------|---|
| TA     | black brushed and anodized  | mounting screws (16), snap washers (16), end caps (8) |
| TC     | silver brushed and anodized | mounting screws (16), snap washers (16), end caps (8) |
| TS     | black powder coat           | mounting screws (16), snap washers (16), end caps (8) |

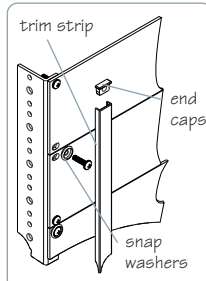

TA/TC/TS mounting method

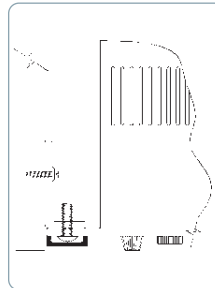

trim strip profile (top view)



without trim strip installed



with trim strip installed

## Silver Locking Trim Panels

Installing silver brushed and anodized custom products? Locking trim panels for slide out racks complement silver products and complete the installation.

| Part #        | Fits                  |
|---------------|-----------------------|
| AXS-CATRIM    | AXS, AX-SX, SAX, SSAX |
| AX-SXR-CATRIM | AX-SXR                |
| SRSR-CATRIM   | SRSR                  |
| SRS-CATRIM    | SRS                   |



silver finish locking trim panel



# Rackmount Storage



D4 with DCDP



DVD partition accommodates, DVDs; PS3, Xbox 360™, Wii™ games; Blu-ray, HD-DVD, DVD-Audio media



DC3 silver finish



TD8FLK

Rear cable grommet and drawer mat now included with all heavy-duty 2, 3 and 4 space drawers, at no extra charge!



Grommet

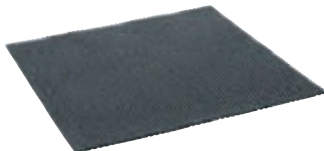

Drawer Mat



UD3

accepts optional latch and keylock



LBX-3

standard keylock



FI-2

## Rack Drawer Quick Reference Guide

| Series | No-Slip Drawer Mat | Rear Cable Gland Grommet | Keylock  | Finish          | Application                 |
|--------|--------------------|--------------------------|----------|-----------------|-----------------------------|
| DC     | included           | included                 | –        | silver anodized | matching aesthetic finishes |
| D*     | included           | included                 | optional | black anodized  | matching aesthetic finishes |
| TD*    | included           | included                 | optional | black textured  | utility                     |
| TD8FLK | optional           | –                        | included | black textured  | hanging file drawer         |
| UD     | optional           | –                        | optional | flat black      | utility                     |

\*5 space drawers do not include grommet and drawer mat

### Heavy-Duty D, DC and TD Series Drawers

Fully enclosed top with inside dimensions measuring 15<sup>7</sup>/<sub>8</sub>" wide by 14<sup>1</sup>/<sub>2</sub>" deep, the D, DC and TD Series drawers feature spring-loaded latches and rugged, straight-forward construction. Installed keylock option available for black anodized and textured models. 2, 3 and 4 space models include drawer mat and rear cable grommet at no extra charge!

| Silver Anodized Part # | Black Anodized Part #* | Black Textured Part #* | Racking Height                            | *Suffix part # with "LK" for installed keylock option |
|------------------------|------------------------|------------------------|---|---|
| DC2                    | D2                     | TD2                    | 3 <sup>1</sup> / <sub>2</sub> " (2 space) |   |
| DC3                    | D3                     | TD3                    | 5 <sup>1</sup> / <sub>4</sub> " (3 space) |   |
| DC4                    | D4                     | TD4                    | 7" (4 space)                              | **Includes file hanging kit and installed keylock     |
|                        | D5                     | TD5                    | 8 <sup>1</sup> / <sub>4</sub> " (5 space) |   |
|                        |                        | TD8FLK**               | 14" (8 space)                             |   |

### UD Series Utility Drawers

The UD Series drawers offer an economical rack storage solution. Full extension ball bearing slides extend a full 14" to reveal inside dimensions measuring 15<sup>7</sup>/<sub>8</sub>" wide by 14<sup>1</sup>/<sub>2</sub>" deep. Each model comes with a face formed drawer pull. User-installed latch and keylock are available options. Black powder coat finish.

| Part # | Racking Height                            | Part #  | Description                     |
|--------|---|---------|---------------------------------|
| UD2    | 3 <sup>1</sup> / <sub>2</sub> " (2 space) | LATCH   | user installed UD latch         |
| UD3    | 5 <sup>1</sup> / <sub>4</sub> " (3 space) | KYLK    | user installed UD keylock       |
| UD4    | 7" (4 space)                              | ACC-KEY | additional set of keys for KYLK |
|        |   | DM      | no-slip drawer mat              |



### Media Partitions for D, DC, TD, and UD Series Drawers

Partition your D, DC, TD, and UD Series drawers for media storage. Featuring a snap-together fit, these partitions are also handy for small parts and misc. hardware.

| Part # | Fits              | Accommodates  |
|--------|-------------------|---|
| DCDP   | D4, DC4, TD4, UD4 | 103 CDs, SA-CD  |
| DVDP   | D4, DC4, TD4, UD4 | 40 DVDs; PS3, Xbox 360™, Wii™ games; Blu-ray, HD-DVD, DVD-Audio media |
| DVHSP  | D3, DC3, TD3, UD3 | 24 VHS tapes in regular case  |

### Lockboxes

Safely secure gear in a rackmount LBX Series lockbox. 9" depth and 17" interior width, 3 and 4 space models are offered with a durable black powder coat finish.

| Part # | Racking Height                            | Depth |
|--------|---|-------|
| LBX-3  | 5 <sup>1</sup> / <sub>4</sub> " (3 space) | 9"    |
| LBX-4  | 7" (4 space)                              | 9"    |

### Customizable Foam Inserts

Customizable foam inserts can be modified to hold any accessory tightly in place. Protects sensitive equipment and tools from shifting or becoming damaged when drawers are opened and closed. Fits any Middle Atlantic Products drawer.

| Part # | Description                                   |
|--------|---|
| FI-2   | customizable foam insert, fits 2 space drawer |
| FI-3   | customizable foam insert, fits 3 space drawer |
| FI-4   | customizable foam insert, fits 4 space drawer |

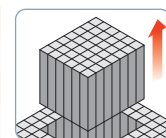

foam sections removable to fit snug against sensitive tools and equipment

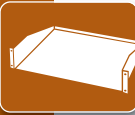

# Rackshelves

## Telescoping Full Depth Heavy Duty Rackshelf

**The most versatile, heavy duty shelf available!**

Unlike standard adjustable shelves, the entire VSA shelf telescopes to reach rear rail, providing a range of useable depths from 16" to 44". Providing the greatest useable depth in its class and featuring a 500 lb. weight capacity, the heavy-duty VSA is ideal for even the deepest components. Constructed of hemmed 16-gauge steel and finished in a durable black powder coat, the VSA is fully vented for superior cooling and features many tie points for enhanced cable management.

| Part #   | Racking Height | Useable Shelf Area                  | Weight Capacity |
|----------|----------------|-------------------------------------|-----------------|
| VSA-1626 | 1½" (<1 space) | 17.25"w x 16" (min.) to 26" (max) d | 500 lbs.        |
| VSA-2744 | 1½" (<1 space) | 17.25"w x 17" (min.) to 44" (max) d | 500 lbs.        |

**HOT TIP!** Easy to mount design requires less open rackspace to install than other 4-point shelves

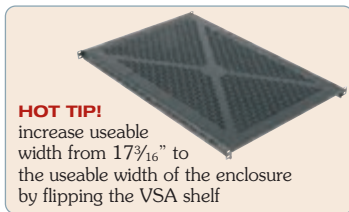

## Adjustable Heavy-Duty Rackshelf

With a front to rear mounting adjustment range from 19½" to 28" deep, the versatile AS3-22 shelf is vented and rackmounts most video decks and tower CPUs. Built expressly for heavy equipment, ships ready-to-assemble with included hardware and supports 450 lbs. NOTE: Fits in racks with a minimum 22½" useable depth.

| Part # | Racking Height | Useable Shelf Area | Weight Capacity |
|--------|----------------|--------------------|-----------------|
| AS3-22 | 5¼" (3 space)  | 17.38"w x 21.5"d   | 450 lbs.        |

23" panel width version also available, with a 25½" useable depth and a rear mounting adjustment from 23½" to 32" deep. NOTE: Fits in racks with a minimum 26¼" useable depth.



| Part #    | Racking Height | Useable Shelf Area | Weight Capacity | Panel Width |
|-----------|----------------|--------------------|-----------------|-------------|
| AS3-26-23 | 5¼" (3 space)  | 21.38"w x 25.5"d   | 450 lbs.        | 23"         |

## Adjustable Deep Rackshelf

The VDS shelf is a vented mounting solution for most deep equipment. This shelf has a front to rear mounting adjustment range from 23½" to 32". Features a substantial 200 lb. weight capacity. NOTE: Fits in racks with a minimum 25½" useable depth.

| Part # | Racking Height | Useable Shelf Area | Weight Capacity |
|--------|----------------|--------------------|-----------------|
| VDS    | 3½" (2 space)  | 17.38"w x 25.6"d   | 200 lbs.        |

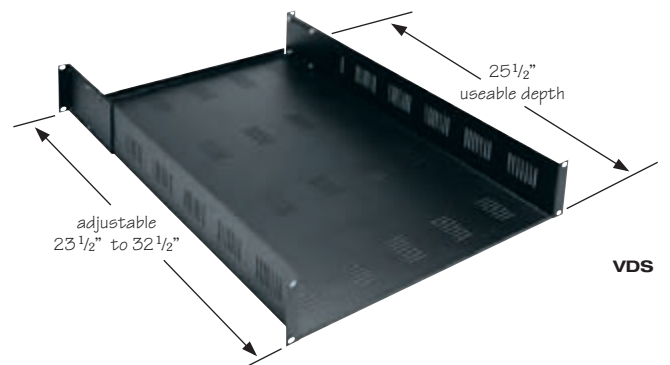
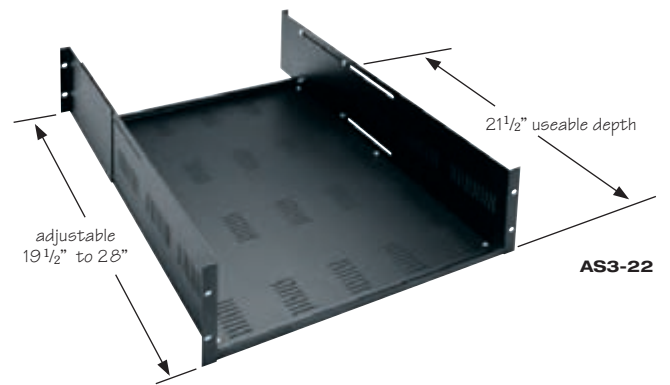
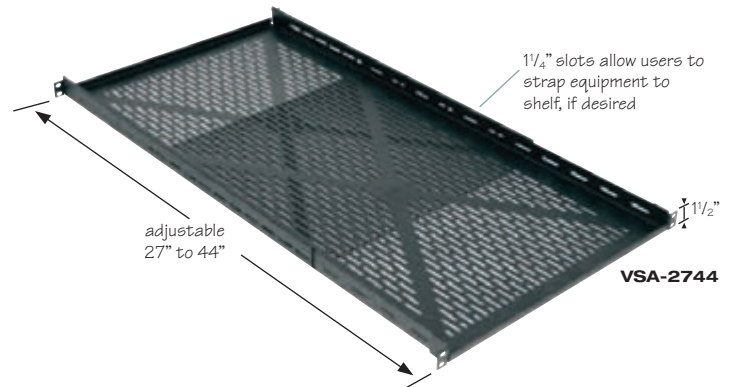
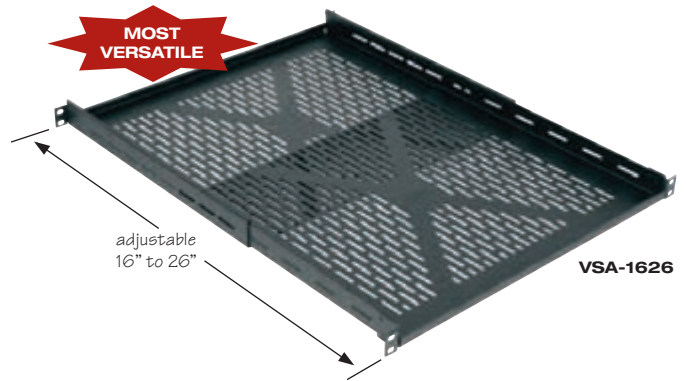

# Rackshelves

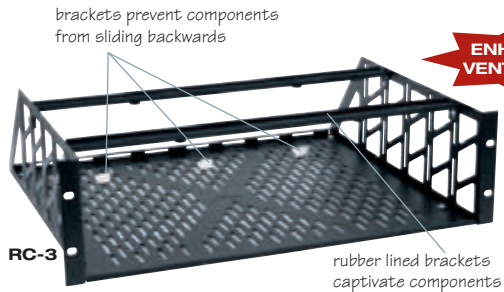

**ENHANCED VENTILATION**



**NEW**  
**PD-815SC-PBSH**  
 rear mount power option available

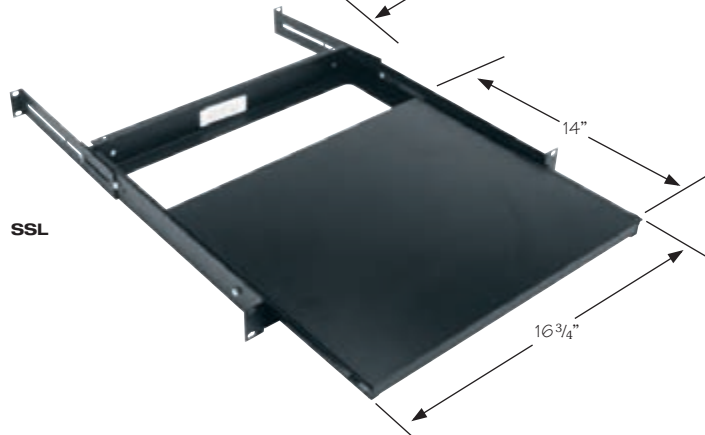
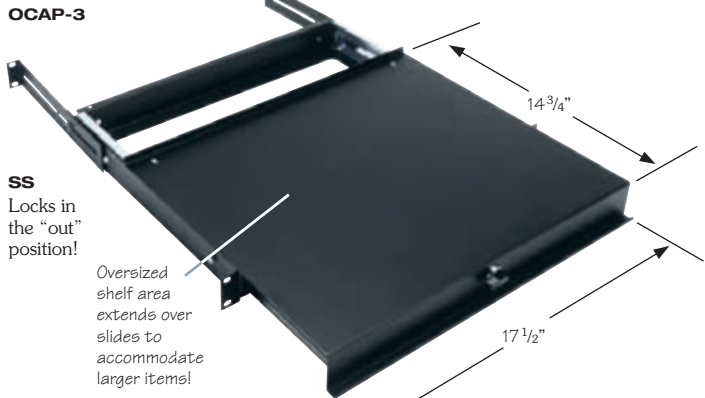
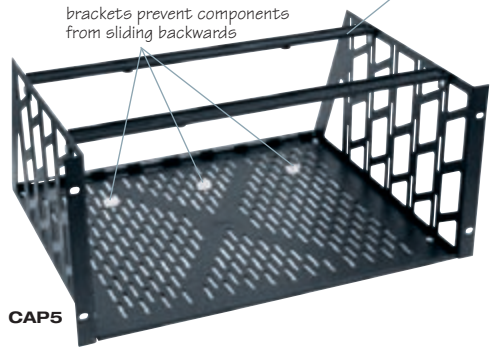

## Clamping Rackshelves

Captivate components with RC and CAP Series clamping rackshelves. Rubber-lined clamps secure a component from the top. Adjustable rear "L" brackets ease a secure fit. Vented bottoms with a robust 16-gauge steel design that maintains structural integrity in mobile applications. Finished in a durable black powder coat.

| Type                | Part # | Racking Height    | Useable Shelf Area  | Clamp Height Range | Weight Capacity |
|---------------------|--------|-------------------|---------------------|--------------------|-----------------|
| ships assembled     | RC-2   | 3 1/2" (2 space)  | 17.38" w x 15.10" d | 1"-2 3/4"          | 50 lbs.         |
|                     | RC-3   | 5 1/4" (3 space)  | 17.38" w x 15.10" d | 2 3/4"-4 5/8"      | 70 lbs.         |
|                     | RC-4   | 7" (4 space)      | 17.38" w x 15.10" d | 4 1/2"-6 3/8"      | 85 lbs.         |
| ships not assembled | CAP5   | 8 3/4" (5 space)  | 17.38" w x 15.10" d | 6 3/8"-8 1/8"      | 100 lbs.        |
|                     | CAP6   | 10 1/2" (6 space) | 17.38" w x 15.10" d | 8"-9 7/8"          | 100 lbs.        |
|                     | CAP7   | 12 1/4" (7 space) | 17.38" w x 15.10" d | 9 3/4"-11 5/8"     | 100 lbs.        |
|                     | CAP8   | 14" (8 space)     | 17.38" w x 15.10" d | 11 1/2"-13 3/8"    | 100 lbs.        |
|                     |        |                   |                     |                    |                 |

## Cable/Satellite Box Captivating Rackshelf

Superior ventilation for cable and satellite boxes or any components that generate considerable heat. Adjustable rubber lined clamping bars on the top and bottom secure components and the open design allows a higher level of equipment density within the rack. Constructed from 16-gauge steel, finished in a durable black powder coat.

A&E SPEC. # 96-01020

| Part # | Racking Height   | Depth | Weight Capacity | Useable Height |
|--------|------------------|-------|-----------------|----------------|
| OCAP-2 | 3 1/2" (2 space) | 14"   | 25 lbs.         | 2 5/8"         |
| OCAP-3 | 5 1/4" (3 space) | 14"   | 25 lbs.         | 4 3/8"         |



## Heavy-Duty Sliding Shelf

The SS sliding shelf is both functional and rugged. Capable of latching in an open or closed position, the shelf slides on ball bearings and extends a full 14" mounts to any rack (rear rackrail required in steel racks) and occupies slightly more than a single rackspace. NOTE: Fits in racks with a minimum 14 3/4" useable depth. Constructed from 16-gauge steel, finished in a durable black powder coat.

UL LISTED

A&E SPEC. # 96-043-1

| Part # | Useable Shelf Area  | Weight Capacity |
|--------|---------------------|-----------------|
| SS     | 17.56" w x 14.75" d | 50 lbs.         |

## Low Profile Sliding Shelf

Filling just a single rackspace, the low profile SSL sliding shelf extends 10" on nylon roller slides equipped with positive-stop lockouts. A telescopic rear support mounts to any rack (rear rackrail required in steel racks). The shelf itself is made with an attractive black laminate material. NOTE: Fits in racks with a minimum 14 3/4" useable depth.

UL LISTED

| Part # | Useable Shelf Area | Weight Capacity |
|--------|--------------------|-----------------|
| SSL    | 16" w x 14" d      | 35 lbs.         |

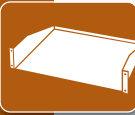

# Rackshelves

## Universal Rackshelves

These easy-to-install universal shelves accommodate components up to 17<sup>3</sup>/<sub>8</sub>" wide. Made from 16-gauge steel, finished in a durable black powder coat and individually boxed.

| Part # | Racking Height                            | Useable Shelf Area  | Capacity | Self Merchandising Rackshelf Packs |          |
|--------|---|---------------------|----------|------------------------------------|----------|
|        |   |                     |          | Part #                             | Quantity |
| U1     | 1 <sup>3</sup> / <sub>4</sub> " (1 space) | 17.44" w x 10.72" d | 35 lbs.  | U1-RP12                            | 12 U1s   |
| U2     | 3 <sup>1</sup> / <sub>2</sub> " (2 space) | 17.44" w x 14.50" d | 50 lbs.  | U2-RP6                             | 6 U2s    |
| U3     | 5 <sup>1</sup> / <sub>4</sub> " (3 space) | 17.44" w x 14.50" d | 70 lbs.  |                                    |          |
| U4     | 7" (4 space)                              | 17.44" w x 15.44" d | 85 lbs.  |                                    |          |

Display U1 and U2 rackshelves in a retail location or will-call area.



## SH Series Zero Space Rackshelves

These 4 point mount shelves have been purpose designed to fit in Slim 5 (pgs. 32-33), AXS (pgs. 49-51), SRSR (pg. 52) and WR (pg.48) equipment racks, and feature full-depth front and rear rackmounting to provide a secure shelf for non-rackmount components. The models designated for the Slim 5, AXS and SRSR mount to the sides of the rackrail, while the SH-WR features an enhanced, patent pending design that mounts to the threaded rail - while still utilizing zero rackspaces! Two handy "L" brackets are included to help position equipment. Constructed from 16-gauge steel, includes mounting hardware and finished in a durable black powdercoat.

| Part #              | Useable Shelf Area  | Weight Capacity | Fits                           |
|---------------------|---------------------|-----------------|--------------------------------|
| SH-5A*              | 18.50" w x 18.57" d | 250 lbs.        | 20" depth AXS & Slim 5 racks   |
| SH-5A-26*           | 18.50" w x 24.57" d | 250 lbs.        | 26" depth AXS & Slim 5 racks   |
| SH-SRSR**           | 18.44" w x 15.50" d | 200 lbs.        | SRSR racks                     |
| SH-WR               | 18.70" w x 22.75" d | 250 lbs.        | WR-xx-32 racks <b>ENHANCED</b> |
| <b>NEW</b> SH-WR-34 | 18.70" w x 32.75" d | 250 lbs.        | WR-xx-42 racks                 |

\*SH-5A, SH-5A-26 does not mount in the top or bottom 2 rackspaces, or where rackrail brackets are located. \*\*SH-SRSR does not mount in the bottom 5 rackspaces, or where rackrail brackets are located.

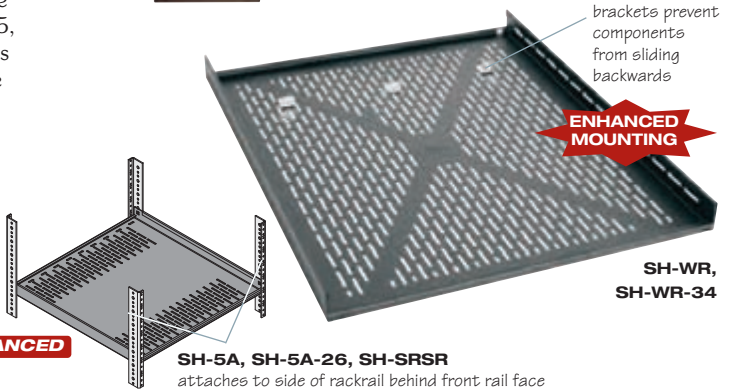

## Vented 3 Space Rackshelf

17<sup>3</sup>/<sub>4</sub>" deep by 5<sup>1</sup>/<sub>4</sub>" high, this vented rackshelf has a 60 lb. weight capacity and a rear flange slotted for horizontal cable management. Constructed from 16-gauge steel and finished in a black powder coat.

| Part # | Racking Height                            | Useable Shelf Area  | Weight Capacity |
|--------|---|---------------------|-----------------|
| U317   | 5 <sup>1</sup> / <sub>4</sub> " (3 space) | 17.44" w x 17.50" d | 60 lbs.         |

### 23" Panel Width Version

| Part #  | Racking Height                            | Useable Shelf Area  | Weight Capacity | Panel Width |
|---------|---|---------------------|-----------------|-------------|
| U317-23 | 5 <sup>1</sup> / <sub>4</sub> " (3 space) | 21.44" w x 17.40" d | 60 lbs.         | 23"         |

## Vented 2 Space Center-Mount Shelf

Ideal for use in our open frame racks (pgs. 56-59), this vented 3<sup>1</sup>/<sub>2</sub>" (2 space) shelf is 18" deep with a 50 lb. weight capacity. Constructed from 16-gauge steel and finished in a durable black powder coat.

| Part # | Racking Height                            | Useable Shelf Area | Weight Capacity | U2MS shown mounted on open frame rack |
|--------|---|--------------------|-----------------|---------------------------------------|
| U2MS   | 3 <sup>1</sup> / <sub>2</sub> " (2 space) | 17.41" w x 18" d   | 50 lbs.         |                                       |

## Half/Third-Rack Shelf

Mount smaller components, wireless units and other gear horizontally w/ the UTR1 half/third-rack shelf. Now includes hook-and-loop strips for component mounting, and features an enhanced ventilation pattern. Constructed from 16-gauge steel with a 25 lb. weight capacity and finished in a durable black powder coat.

| Part # | Racking Height                            | Useable Shelf Area | Weight Capacity | Self Merchandising Rackshelf Packs |          |
|--------|---|--------------------|-----------------|------------------------------------|----------|
|        |   |                    |                 | Part #                             | Quantity |
| UTR1   | 1 <sup>3</sup> / <sub>4</sub> " (1 space) | 17.38" w x 10" d   | 25 lbs.         | UTR1-RP12                          | 12 UTR1s |

This attractive rackshelf pack displays UTR1 rackshelves in a retail location or will-call area.

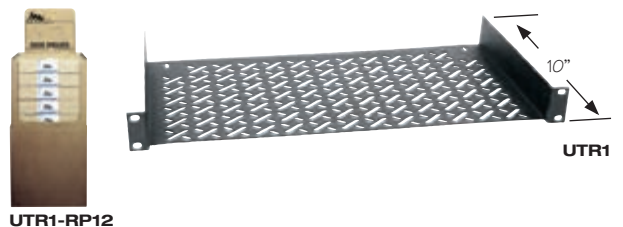

UL US LISTED

A&E SPEC. # 96-047

A&E SPEC. # 96-969

UL LISTED

NEW

A&E SPEC. # 96-047



# Rackshelves

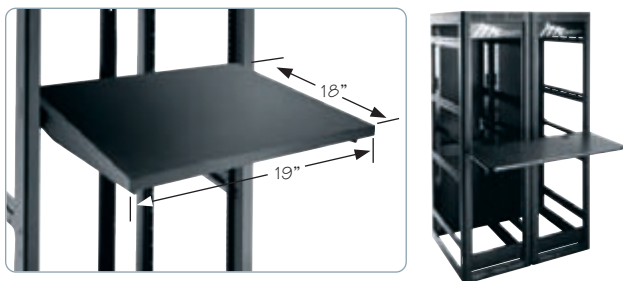
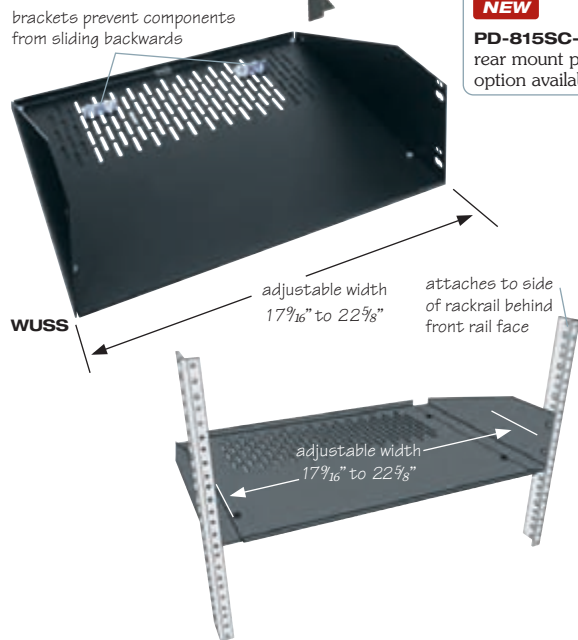
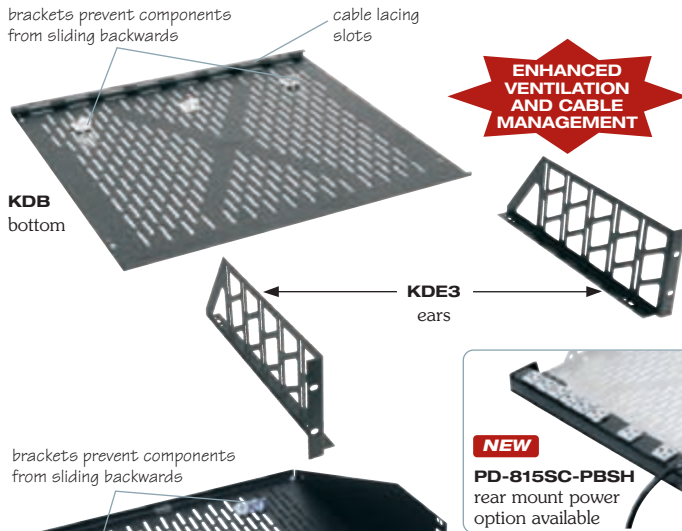

for multi-bay applications, please see our WS Series work surfaces on pg. 27

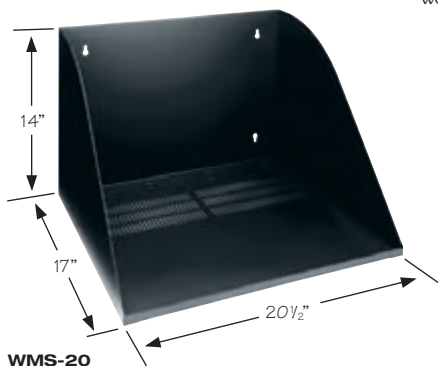

## Ready-to-Assemble Shelves

Vented KD Series rackshelves ship ready-to-assemble to minimize freight costs and save storage space. Ear heights range from 2 to 10 spaces and are sold in pairs. All assembly hardware included.

| Ear Part # | Racking Height     | Depth   | Weight Capacity | Bottom Part # | Useable Shelf Area                            |
|------------|--------------------|---------|-----------------|---------------|---|
| KDE2       | 3 1/2" (2 space)   | 15 1/2" | 50 lbs.         | KDB           | 17.38" w x 15.10" d                           |
| KDE2S      | 3 1/2" (2 space)   | 11 1/2" | 50 lbs.         | KDB-14*       | 17.38" w x 13.65" d                           |
| KDE3       | 5 1/4" (3 space)   | 15 1/2" | 70 lbs.         | KDB-17.5      | 17.38" w x 17.15" d                           |
| KDE3S      | 5 1/4" (3 space)   | 11 1/2" | 70 lbs.         | KDB-20.5      | 17.38" w x 20.15" d                           |
| KDE4       | 7" (4 space)       | 15 1/2" | 85 lbs.         |               | *Fits our DWR Series and other shallow racks! |
| KDE4S      | 7" (4 space)       | 11 1/2" | 85 lbs.         |               | (use with 11 1/2" ears)                       |
| KDE5       | 8 3/4" (5 space)   | 15 1/2" | 100 lbs.        |               |   |
| KDE6       | 10 1/2" (6 space)  | 15 1/2" | 100 lbs.        |               |   |
| KDE10      | 17 1/2" (10 space) | 15 1/2" | 100 lbs.        |               |   |

## Wide Unit Shelf System

Accommodating components too wide to fit the 17 3/8" inside width of standard rackshelves, these shelf systems fit units up to 22 1/2" wide, and either bolt into millwork or to the mounting angle of standard rackrail. Measuring 5 1/4" high, this shelf saves room by requiring no rack-spaces. The WUSS system comes complete with a pair of ears, a bottom, and appropriate assembly hardware. NOTE: This rackshelf works with all Middle Atlantic Products enclosures with the exception of the VMRK-54, which uses 'Z-Rail.'

| Part #   | Useable Shelf Area                         | Weight Capacity |
|----------|--|-----------------|
| WUSS11.5 | 17.38" (min.) to 22.63" (max) w x 11.38" d | 50 lbs.         |
| WUSS14*  | 17.38" (min.) to 22.63" (max) w x 13.83" d | 50 lbs.         |
| WUSS15.5 | 17.38" (min.) to 22.63" (max) w x 15.33" d | 50 lbs.         |
| WUSS17.5 | 17.38" (min.) to 22.63" (max) w x 17.38" d | 50 lbs.         |
| WUSS20.5 | 17.38" (min.) to 22.63" (max) w x 20.38" d | 50 lbs.         |

\*Available in 14" depth - fits DWR Series and other shallow racks!

## Fixed Writing/Computer Keyboard Shelf

The FWS fixed single bay writing/computer keyboard shelf bolts quickly to any 19" rack to create an ideal workspace. With an attractive, black laminate top made from 3/4" furniture-grade MDF board, it occupies 2 rackspaces and comes complete with special rail-mounting hardware.

| Part # | Useable Shelf Area | Weight Capacity |
|--------|--------------------|-----------------|
| FWS    | 19" w x 18" d      | 100 lbs.        |

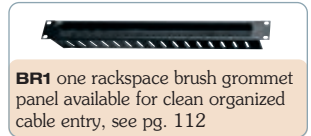

BR1 one rackspace brush grommet panel available for clean organized cable entry, see pg. 112

## Wall Mount Shelf

Wall mounting non-rackmount components is much easier with our fully welded WMS wall mount shelf. The bottom is vented to help keep things cool and features 1/2" and 3/4" electrical knockouts for cable pass-through.

| Part # | Useable Shelf Area  | Weight Capacity |
|--------|---------------------|-----------------|
| WMS-20 | 20.63" w x 16.81" d | 200 lbs.        |

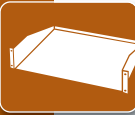

# UCP Panels, Rackmount Chassis And Access Panels

## Decora® Panel

One space Decora® panels mount any low-voltage Decora® device directly onto the rackrail of a standard 19" enclosure. Decora® panels accommodate as many as four Decora® devices including the RPS Series remote power switch, LT-DEC light and the TEMP-DEC temperature display. Pre-configured panels are available with pre-installed Decora® products for simplified ordering, see pg. 79 for more details. Constructed from one-piece flanged steel (with an open area of 1.62" between flanges), black powder coat finish.

| Part #   | Description   |
|----------|---|
| DECP-1X1 | 1 3/4" (1 space) mounts up to 1 Decora® devices                   |
| DECP-1X2 | 1 3/4" (1 space) mounts up to 2 Decora® devices                   |
| DECP-1X3 | 1 3/4" (1 space) mounts up to 3 Decora® devices                   |
| DECP-1X4 | 1 3/4" (1 space) mounts up to 4 Decora® devices                   |
| LT2P     | pre-configured with 2 LT-DEC lights                               |
| LT2-T1P  | pre-configured w/ 2 LT-DEC lights, 1 TEMP-DEC temperature display |
| T1P      | pre-configured w/ 1 TEMP-DEC temperature display                  |

## Universal Connector Panel

The UNI series laser-cut connector panels feature knockouts designed to accept a number of connectors, including XLR and Neutrik. The innovative design allows mounting of both male and female connectors to the same holes simply by knocking out the correct pattern. The UNI-1-C incorporates a 2 5/8" strain relief shelf with tie-points for cable management. Made from one-piece flanged steel, black powder coat finish.

| Part #  | Laser-Cut Knockouts | Racking Height                       |
|---------|---------------------|--------------------------------------|
| UNI-1   | 16                  | 1 3/4" (1 space)                     |
| UNI-2   | 32                  | 3 1/2" (2 space)                     |
| UNI-1-C | 16                  | 1 3/4" (1 space) - incl. cable mgmt. |

## CH Chassis

With its aesthetically-balanced, screwless flush-mounted faceplate, our CH Chassis features a 16-gauge all-steel body finished in a black powder coat. Front and rear panels are made from aluminum for easy machining. The front faceplate additionally features a black brushed and anodized finish, while the rear faceplate is finished in a black powder coat.

| Part # | Racking Height   | Depth |
|--------|------------------|-------|
| CH1    | 1 3/4" (1 space) | 10"   |
| CH2    | 3 1/2" (2 space) | 10"   |
| CH3    | 5 1/4" (3 space) | 10"   |

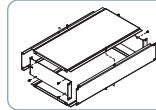

front and rear panels detach for simplified machining

## Econo Chassis

Providing a high quality rack chassis at an affordable price, the EC Series features a quick-to-disassemble two piece design incorporating a 16-gauge steel face, back and bottom, and 20-gauge steel top and sides. Black powder coat finish.

| Part # | Racking Height   | Depth |
|--------|------------------|-------|
| EC-1   | 1 3/4" (1 space) | 6"    |
| EC-2   | 3 1/2" (2 space) | 6"    |
| EC-3   | 5 1/4" (3 space) | 6"    |

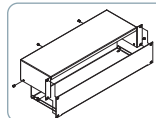

two piece design for easy assembly

## Access Panels

Available in 2, 4, and 6 space models, these hinged access panels provide quick passage to rack interiors. Solid and vented panels available. Fabricated from easily machinable 13-gauge black powder coated aluminum, these access panels are perfect for those situations where access to the rear of connector panels is required. Captive 10-32 threaded thumbscrews require no tools to open and will not get lost.

| Solid Part # | Vented Part # | Racking Height    |
|--------------|---------------|-------------------|
| AP-2         | APV-2         | 3 1/2" (2 space)  |
| AP-4         | APV-4         | 7" (4 space)      |
| AP-6         | APV-6         | 10 1/2" (6 space) |



DECP-1X1



DECP-1X2



DECP-1X3



DECP-1X4

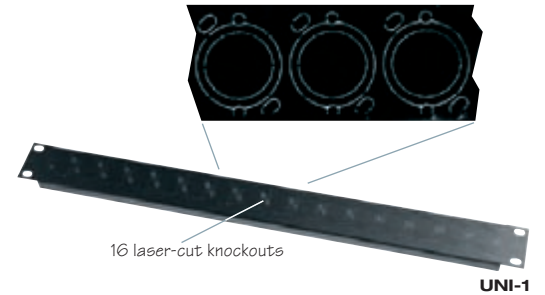

16 laser-cut knockouts

UNI-1

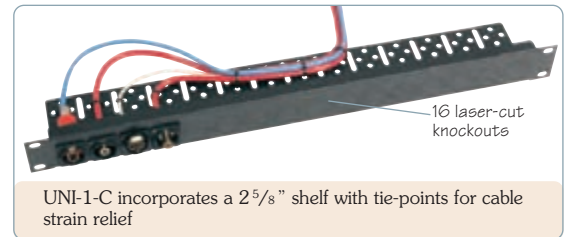

16 laser-cut knockouts

UNI-1-C incorporates a 2 5/8" shelf with tie-points for cable strain relief

UNI-1-C



CH2



EC-2



APV-4



AP-4

A&E SPEC. # 96-004

# Security Covers And Access Control

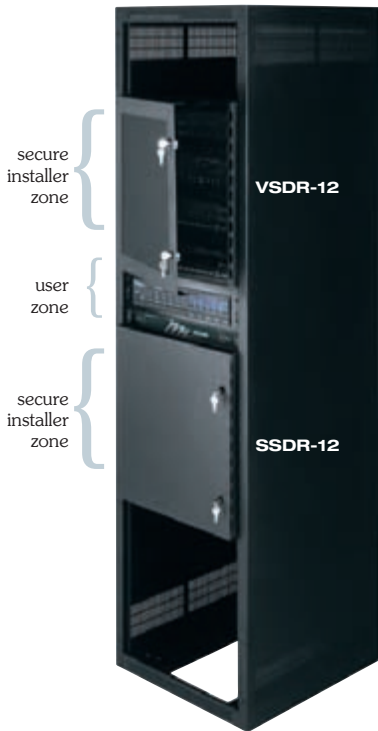

## Security Doors

Keylocked security doors allow front access to a select portion of rackmount equipment and are available in plexiglass, vented, and solid styles. Mount equipment which needs to be secured behind these doors in the “installer zone” to keep unauthorized users from tampering. Keep equipment which needs to be client-accessed in the open portion of the rack in the “user zone.”

| Solid Part #<br>Knob Clearance 1 <sup>3</sup> / <sub>8</sub> " | Plexi Part #<br>Knob Clearance 1 <sup>1</sup> / <sub>8</sub> " | Vented Part #<br>Knob Clearance 1 <sup>3</sup> / <sub>8</sub> " | Racking Height                              |
|--|--|---|---|
| SSDR-8   | PSDR-8   | VSDR-8  | 14" (8 space)                               |
| SSDR-12  | PSDR-12  | VSDR-12   | 21" (12 space)                              |
| SSDR-15  | -  | -   | 26 <sup>1</sup> / <sub>4</sub> " (15 space) |
| SSDR-16  | PSDR-16  | VSDR-16   | 28" (16 space)                              |
| SSDR-20  | PSDR-20  | VSDR-20   | 35" (20 space)                              |
| SSDR-21  | -  | -   | 36 <sup>3</sup> / <sub>4</sub> " (21 space) |

## Hinged Plexiglass Security Covers

Incorporating a steel frame and a keylocked 3/16" smoked-gray plexiglass door, our SECL Series locking security covers are offered in 2, 3, 4, and 8 space sizes. Each unit's depth of 1 1/2" easily clears controls on most equipment.

| Part # | Racking Height   |
|--------|------------------|
| SECL-2 | 3 1/2" (2 space) |
| SECL-3 | 5 1/4" (3 space) |
| SECL-4 | 7" (4 space)     |
| SECL-8 | 14" (8 space)    |

## Perforated Security Covers

Eliminate the prospect of tampering with these tough security covers. Offered in large or fine perforation styles (models S and SF respectively), each cover is 1" deep. Includes installed rubber edging that won't mar the equipment you're trying to protect. To enhance the level of security, use the patented Guardian Series™ security bit and HSK rack screws (pg. 132).

| Type   | Part # | Description                            |
|--|--------|--|
| allows unobstructed view of knob settings, 64% open area | S1     | 1 3/4" (1 space) regular perf. pattern |
|  | S2     | 3 1/2" (2 space) regular perf. pattern |
|  | S3     | 5 1/4" (3 space) regular perf. pattern |
|  | S4     | 7" (4 space) regular perf. pattern     |
| allows sight of LEDs most secure, 25% open area          | SF1    | 1 3/4" (1 space) fine perf. pattern    |
|  | SF2    | 3 1/2" (2 space) fine perf. pattern    |
|  | SF3    | 5 1/4" (3 space) fine perf. pattern    |
|  | SF4    | 7" (4 space) fine perf. pattern        |

## Plexiglass Security Covers

SL Series security covers feature a permanent plexiglass window for easy equipment viewing. Secure and cost-effective - available in 1, 2, and 3 space sizes, 1" deep.

| Part # | Racking Height   |
|--------|------------------|
| SL-1   | 1 3/4" (1 space) |
| SL-2   | 3 1/2" (2 space) |
| SL-3   | 5 1/4" (3 space) |

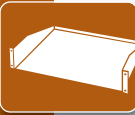

# UCP Series Modular Custom Panel System

## Build Your Own Custom Connector Panel Using Off-The-Shelf Components!

Design and build your own custom connector panels using off-the-shelf materials! Our UCP Series modular custom panel system assembles quickly and easily using either a 2 or 4 space frame kit and your selections from an extensive collection of prepunched modules. UCP modular assemblies simply bolt together using supplied hardware. A single tier of five modules bolts across a 2 space frame kit, two tiers of five modules bolt across a 4 space frame kit. Modules are prepunched to accept XLR, Neutrik, Elco, Canare and a host of other connector configurations (see accompanying diagrams). The inherent strength of the interlocking system eliminates panel deflection while inserting or removing connectors. When completed, all hardware is flush to create a professional appearance with no unsightly gaps. Visible parts have a black brushed and anodized finish. All modules are constructed of aluminum. Blank and vented panels are also available to fill unused spots.

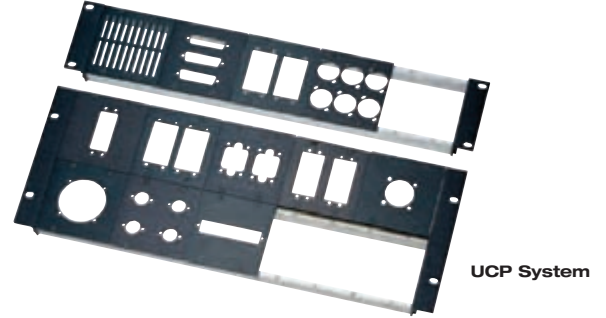
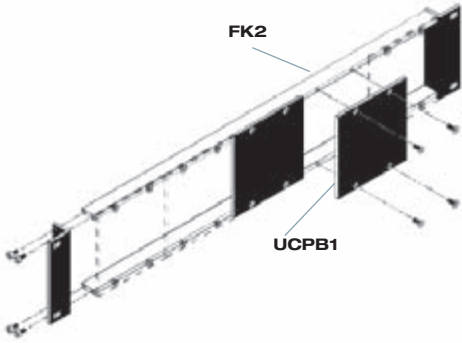

### Frame Kits

Bolt modules to them in any combination.

| Part # | Racking Height |
|--------|----------------|
| FK2    | 3½" (2 space)  |
| FK4    | 7" (4 space)   |

**NEED SOMETHING YOU DON'T SEE? Please Call!**

### Blank Module

Available for filling unused spots or drill your own connector mounting pattern.

| Part # | Width  |
|--------|--------|
| UCPB1  | single |
| UCPB2  | double |
| UCPB3  | triple |

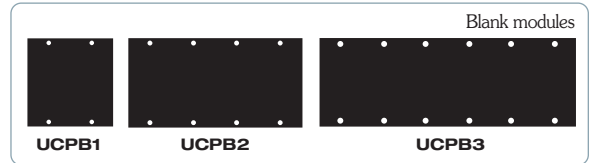

**NEW** BANA Punchouts: Fits dual banana jack receptacles requiring up to 3/8" hole

|          |          |          |
|----------|----------|----------|
|          |          |          |
| 3/8BANA2 | 3/8BANA4 | 3/8BANA6 |

Banana Punchouts: Fits the universal dual banana jack receptacle.

|       |       |       |
|-------|-------|-------|
|       |       |       |
| BANA2 | BANA4 | BANA6 |

### UCP Vent

Fills unused spaces while providing ventilation.

| Part # |
|--------|
| UCP-VT |

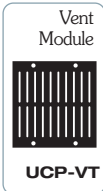

XLR Style Male Punchouts: Fits Neutrik MP, LNEMP, Switchcraft, Cannon.

|       |
|-------|
|       |
| XLRM6 |

Combo Female/Male XLR Punchouts: Fits mixed genders within a module.

|        |        |        |
|--------|--------|--------|
|        |        |        |
| COMBO2 | COMBO4 | COMBO6 |

### UCP Adapter

Adapts any single UCP module to a standard 1900 electrical box.

| Part #  |
|---------|
| UCP-ADP |

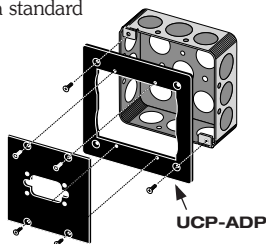

Universal XLR Female Punchouts: Fits Neutrik FP, MP, MDL, FDL, small Speakon, Switchcraft female XLRs, Cannon, Whirlwind (male XLRs fit as well, but leave a small gap on sides).

|       |       |       |       |       |
|-------|-------|-------|-------|-------|
|       |       |       |       |       |
| UNIV1 | UNIV2 | UNIV3 | UNIV4 | UNIV6 |

Circular Flange 4 Bolt Punchouts: Fits Cannon AP and EP, Neutrik NL8MPR, NL4MPR ("Speakon").

|      |      |
|------|------|
|      |      |
| 4SC1 | 4SC3 |



# UCP Series Options

**"DB" Style Punchouts:** Fits the popular data multipin. 1DB9M fits HD15(SVGA) and additional 1/8" mini phone jack for easy laptop connection.

1DB9M 1DB9 2DB9 3DB9 4DB9 2DB37  
1DB15 2DB15 1DB25 2DB25 2DB50

**Multipin Elco/Edac Punchouts:**  
Fits 38, 56, 90 and 120 pin connectors.

1ELCO38 1ELCO56 1ELCO90 1ELCO120  
2ELCO38 2ELCO56 2ELCO90

**Multipin AMP Punchouts:**  
Fits "G" Series connectors.

1G1 1G2 1G3  
CANARE4

**1/4" Diameter Punchouts:**  
Fits RCA jacks, some switches and LEDs.

**3/8" Diameter Punchouts:**  
Fits attenuators, "F" connectors, phone jacks, some switches.

**7/16" Diameter Punchouts:**  
Fits Switchcraft #11, insulated phone jack, some switches.

3/8X1 1/4X2 1/4X4 3/8X4 7/16X4  
3/8X6 3/8X8

**Twistlock Punchouts:**  
Fits most brands with oval mounting hole pattern (Hubbel Bryant, etc.)  
Use Part #TW2B for 2 bolt twistlocks and other 2 bolt devices. Use Part #TW3B for 3 bolt twistlocks.

TW2B TW3B

**1/2" Diameter "D" punchouts:** Fits 1/2" insulated BNC connectors for RGBHV.

1/2BNC5

**3/8" Diameter Punchouts:**  
Fits 3/8" insulated RCA connectors for component video & audio.

3/8X5

**Multipin Whirlwind Punchouts:**  
Fits 39 and 61 pin.

1W1 1W2

**Duplex Receptacle Punchouts:**  
Removal of receptacle ears is necessary to fit between UCP bars.

DUP1 DUP2

Note: for low voltage applications only.

**Keystone Punchouts:** Accommodates a variety of connectors including RCA, Rj 11/12/45, F, BNC feedthrough, Banana, ST Fiber, etc.\*

KEY-1 KEY-2 KEY-4 KEY-6

\*keystone insert bezel not required for connector installation

**BNC Punchouts:**  
Fits 1/2" and 3/8" diameter BNC shells, most insulated shells and fuses.

1/2BNC1 1/2BNC2 1/2BNC3 1/2BNC4 3/8BNC4

**DL Series Multipins,** by Cannon

2DL96

**Socapex 19 pin**

SPX-19

**RPS Series remote power switch** (see pg. 79 for information)

UCP-RPS

## UCP Fan

Extend equipment life by removing heat from within an enclosure. Operates on 12VDC using integral 12" long pigtail leads, includes power supply.

| Part #  | Free Air dB Rating | Free Air CFM |
|---------|--------------------|--------------|
| UCP-FAN | 25 dBA             | 15           |

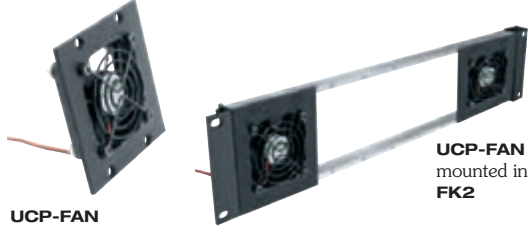

## UCP Chassis

The 2 space UCP chassis holds five modules in the front, and five modules in the rear. Shipped fully-assembled, each unit is comprised of four threaded FK bars, a pair of ears 9" deep, top and bottom, and all necessary module mounting hardware. The top and bottom can be easily removed, leaving the frame intact.

| Part # |
|--------|
| UCP-CH |



## UCP FK2 Swinging Frame

This hinged version of the FK2 frame kit allows rear access to modules. Captive 10-32 threaded thumbscrews hold the frame closed and require no tools to open. Kit includes a pair of threaded FK bars, hinged ear, captive thumbscrew ear, and all module mounting hardware. Occupies 2 rackspaces (3 1/2").

| Part # |
|--------|
| UCP-SF |



## UCP Cable Tray

The UCP cable tray includes FK2 bars, mounting ears and bottom. 5" deep tray provides superior cable strain relief with a multitude of wire-tie slots. Occupies 2 rackspaces (3 1/2").

| Part # |
|--------|
| UCP-CT |



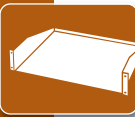

# Blank Panels

## EB/FEB Series

A&E SPEC.  
# 96-001-1

Available in a choice of flanged or flat style, these economical steel blank panels feature a durable black powder coat finish. EB Series panels are 16-gauge, FEB Series panels are 14-gauge steel.

| Flanged Part # | Flat Part # | Racking Height | Contractor Packs |           |     | 23" Panel Width Flanged Blank Panels |                |
|----------------|-------------|----------------|------------------|-----------|-----|--------------------------------------|----------------|
|                |             |                | Part #           | Part #    | Qty | Flanged Part #                       | Racking Height |
| EB1            | FEB1        | 1¾" (1 space)  |                  |           |     | EB1-23                               | 1¾" (1 space)  |
| EB2            | FEB2        | 3½" (2 space)  | EB1-CP12         | FEB1-CP12 | 12  | EB2-23                               | 3½" (2 space)  |
| EB3            | FEB3        | 5¼" (3 space)  | EB2-CP12         | FEB2-CP12 | 12  | EB3-23                               | 5¼" (3 space)  |
| EB4            | FEB4        | 7" (4 space)   | EB3-CP6          | FEB3-CP6  | 6   | EB4-23                               | 7" (4 space)   |
| EB5            | FEB5        | 8¾" (5 space)  | EB4-CP6          | FEB4-CP6  | 6   |                                      |                |
| EB6            | FEB6        | 10½" (6 space) |                  |           |     |                                      |                |



**EB2-CP12**  
Contractor packs available!

**Contractor Packs** provide a cost-effective, space-efficient way for installers to stock the panels they use most frequently. Allows easy access to individual, poly-bagged panels. Designed to stack on warehouse shelving.

## PBL Series

A&E SPEC.  
# 96-001-1

The lightweight, 16-gauge aluminum construction found in the PBL Series makes for easy machining. Flanged for extra strength, durable black powder coat finish.

| Part # | Racking Height | Contractor Packs |     |
|--------|----------------|------------------|-----|
|        |                | Part #           | Qty |
| PBL-1  | 1¾" (1 space)  | PBL1-CP12        | 12  |
| PBL-2  | 3½" (2 space)  | PBL2-CP12        | 12  |
| PBL-3  | 5¼" (3 space)  | PBL3-CP6         | 6   |
| PBL-4  | 7" (4 space)   | PBL4-CP6         | 6   |



**PBL3-CP6**  
Contractor packs available!



**HOT TIP!** Easy to machine

## PHBL Series

A&E SPEC.  
# 96-001-1

A flat, lightweight 11-gauge aluminum design makes every PHBL Series blank panel easy to machine. Durable black powder coat finish.

| Part # | Racking Height | Contractor Packs |     |
|--------|----------------|------------------|-----|
|        |                | Part #           | Qty |
| PHBL-1 | 1¾" (1 space)  | PHBL1-CP12       | 12  |
| PHBL-2 | 3½" (2 space)  | PHBL2-CP12       | 12  |
| PHBL-3 | 5¼" (3 space)  | PHBL3-CP6        | 6   |
| PHBL-4 | 7" (4 space)   | PHBL4-CP6        | 6   |



**PHBL2-CP12**  
Contractor packs available!



**HOT TIP!** Easy to machine

## SB Series

A&E SPEC.  
# 96-001-1

A textured black powder coat finish is used throughout the SB Series. Flanged for strength, each model is made from 16-gauge steel.

| Part # | Racking Height | Contractor Packs |     |
|--------|----------------|------------------|-----|
|        |                | Part #           | Qty |
| SB1    | 1¾" (1 space)  | SB1-CP12         | 12  |
| SB2    | 3½" (2 space)  | SB2-CP12         | 12  |
| SB3    | 5¼" (3 space)  | SB3-CP6          | 6   |
| SB4    | 7" (4 space)   | SB4-CP6          | 6   |
| SB5    | 8¾" (5 space)  |                  |     |
| SB6    | 10½" (6 space) |                  |     |



**SB4-CP6**  
Contractor packs available!

## BL Series

A&E SPEC.  
# 96-001-1

An attractive series of blank panels, BL products utilize a 16-gauge aluminum flanged design. Easy to machine, black brushed and anodized.

| Part # | Racking Height |
|--------|----------------|
| BL1    | 1¾" (1 space)  |
| BL2    | 3½" (2 space)  |
| BL3    | 5¼" (3 space)  |
| BL4    | 7" (4 space)   |



**BL2**  
**HBL2**

## HBL/CHBL Series

A&E SPEC.  
# 96-001-1

Eye-pleasing aesthetics and flat, 11-gauge aluminum construction combine in this easy-to-machine series of blank panels. Black brushed and anodized or silver brushed and anodized finish.

| Black Anodized Part # | Silver Anodized Part # | Racking Height |
|-----------------------|------------------------|----------------|
| HBL1                  | CHBL1                  | 1¾" (1 space)  |
| HBL2                  | CHBL2                  | 3½" (2 space)  |
| HBL3                  | CHBL3                  | 5¼" (3 space)  |
| HBL4                  | CHBL4                  | 7" (4 space)   |
| HBL5                  | -                      | 8¾" (5 space)  |
| HBL6                  | -                      | 10½" (6 space) |



**CHBL2**

**HOT TIP!** Use with RSH Series custom rackshelves



# Vent Panels



VTB-1

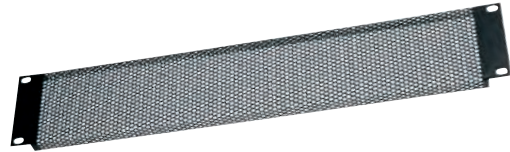

VT2



VTF2

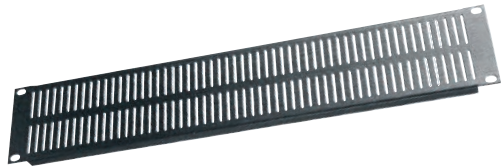

EVT2

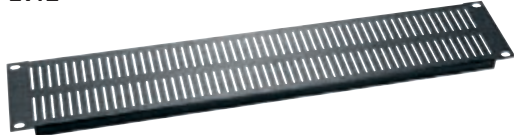

EVTA-2



EVTC-2

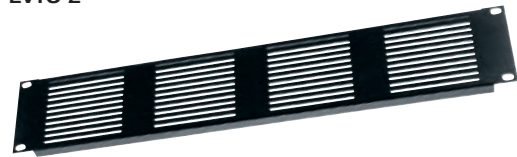

VTP-2



CVTP-2

## Light Blocking Vent Panels

A&E SPEC.  
# 96-050-1

This vent panel is the ideal solution for installations where a high open percentage area (64%) vent is needed, and it is desirable to conceal the internal cabling. Includes pre-installed light blocking material. Constructed from 18-gauge perforated steel, flanged for extra strength, and finished in a black powder coat.

| Part # | Racking Height   |
|--------|------------------|
| VTB-1  | 1 3/4" (1 space) |
| VTB-2  | 3 1/2" (2 space) |
| VTB-3  | 5 1/4" (3 space) |

## VT Vent Panels

A&E SPEC.  
# 96-050-1

With the highest percentage of open area found on any of our vent panels (64%), all VT Series products are made from 18-gauge perforated steel, and are flanged for extra strength. Black powder coat finish.

| Part # | Racking Height   | Contractor Packs |     |
|--------|------------------|------------------|-----|
|        |                  | Part #           | Qty |
| VT1    | 1 3/4" (1 space) | VT1-CP12         | 12  |
| VT2    | 3 1/2" (2 space) | VT2-CP12         | 12  |
| VT3    | 5 1/4" (3 space) | VT3-CP6          | 6   |
| VT4    | 7" (4 space)     | VT4-CP6          | 6   |



VT2-CP12  
Contractor packs available!

## VTF Vent Panels

A&E SPEC.  
# 96-050-1

The tight perforated pattern found in the VTF Series of vent panels limits viewing for aesthetics. Flanged, made from 18-gauge steel, with a 25% open area. Black powder coat finish.

| Part # | Racking Height   | Contractor Packs |     |
|--------|------------------|------------------|-----|
|        |                  | Part #           | Qty |
| VTF1   | 1 3/4" (1 space) | VTF1-CP12        | 12  |
| VTF2   | 3 1/2" (2 space) | VTF2-CP12        | 12  |
| VTF3   | 5 1/4" (3 space) | VTF3-CP6         | 6   |
| VTF4   | 7" (4 space)     | VTF4-CP6         | 6   |



VTF4-CP6  
Contractor packs available!

## EVT Vent Panels

A&E SPEC.  
# 96-050-1

Featuring an aesthetically pleasing vertical slotted design, EVT Series vent panels have a 17% open area and are available with a 16-gauge steel construction in a black powder coat finish (EVT) or an aluminum construction with a choice of a black brushed and anodized (EVTA) or silver brushed and anodized finish (EVTC).

| Black Powder Coat Part # (Steel) | Black Anodized Part # (Aluminum) | Silver Anodized Part # (Aluminum) | Racking Height   |
|----------------------------------|----------------------------------|-----------------------------------|------------------|
| EVT1                             | EVTA-1                           | EVTC-1                            | 1 3/4" (1 space) |
| EVT2                             | EVTA-2                           | EVTC-2                            | 3 1/2" (2 space) |



**HOT TIP!**  
Choose a vent pattern that best complements the aesthetics of the rackmount equipment

### Contractor Packs

| Part #    | Qty |
|-----------|-----|
| EVT1-CP12 | 12  |
| EVT2-CP12 | 12  |



EVT1-CP12  
Contractor packs available!

## VTP/CVTP Vent Panels

A&E SPEC.  
# 96-050-1

Highly aesthetic with an attractive horizontal slotted design, the rust-resistant VTP Series is flanged, made from 16-gauge aluminum and has a 20% open area. Black brushed and anodized or silver brushed and anodized finish.

| Black Anodized Part # | Silver Anodized Part # | Racking Height   |
|-----------------------|------------------------|------------------|
| VTP-1                 | CVTP-1                 | 1 3/4" (1 space) |
| VTP-2                 | CVTP-2                 | 3 1/2" (2 space) |
| VTP-3                 | CVTP-3                 | 5 1/4" (3 space) |

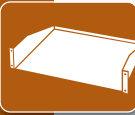

# Rack Screws

## Premium Rack Screws

Premium rack screws provide the best bit engagement in the industry. HG hardware features salt spray resistant plating that slows rust build-up. HM hardware features an attractive black matte finish. Both types are truss-head hardware, 10-32 threaded, 3/4" long with pre-installed washers and self-guiding pilot points.

| Part # | Qty                       | Finish                            |
|--------|---------------------------|-----------------------------------|
| HG     | 100 pc.                   | salt spray resistant, black gloss |
| HG500  | 500 pc. in a reusable jar | salt spray resistant, black gloss |
| HM     | 100 pc.                   | black matte                       |
| HM500  | 500 pc. in a reusable jar | black matte                       |

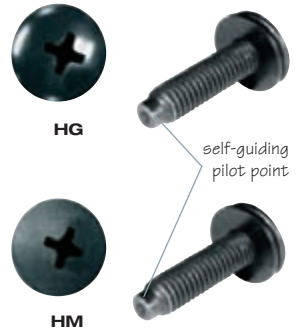

## Standard Rack Screws

Standard 3/4" long rack screws with 10-32 threads feature self-guiding pilot points. HP Series truss head screws provide a clean, modern appearance and fit under optional trim strips (see pg. 120) for the most attractive finish. HW Series trim-head screws feature a classic appearance. Includes factory-installed nylon washer.

| Black Part # | Silver Part # | Head       | Qty                       |
|--------------|---------------|------------|---------------------------|
| HP500        | -             | truss-head | 500 pc. in a reusable jar |
| HP           | CHP           | truss-head | 100 pc.                   |
| HPS          | -             | truss-head | 25 pc.                    |
| HW500        | -             | trim-head  | 500 pc. in a reusable jar |
| HW100        | -             | trim-head  | 100 pc.                   |

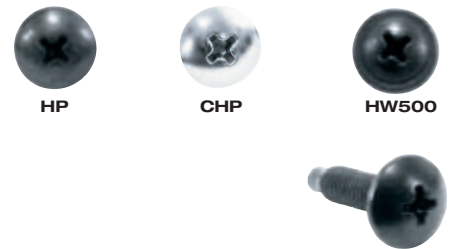

## Security Rack Screws

Security screws are the ideal way to keep people from tampering with rackmounted equipment. The highest security patented Guardian Series™ hardware is unique to Middle Atlantic Products and features a square post drive that cannot be found elsewhere. All screws are 10-32 by 3/4" and include factory-installed black nylon washer and black finish.

| Rack Screw Part # | Qty            | Bit Part # | Description   |
|-------------------|----------------|------------|---|
| HSK               | 100 pc. screws | SPBIT      | Highest Security patented square post drive bit to drive HSK Guardian Series™ security screws |
| HTX               | 50 pc. screws  | TBIT       | star post bit to drive HTX security screws  |
| HS                | 100 pc. screws | SBIT       | square drive bit to drive HS security screws  |

HSK Guardian Series™ security hardware



## Cable Friendly Short Rack Screws

Cable friendly HPQ Series screws are 3/8" long with 10-32 threads and feature a rounded end to allow wires to be dressed inside front rackrail without chafing. Featuring an attractive Phillips truss head, finished in black.

| Part #  | Quantity                  |
|---------|---------------------------|
| HPQ-500 | 500 pc. in a reusable jar |
| HPQ     | 100 pc.                   |



## Cage Nut Hardware

Cage nuts fit our cage-nut style rackrail and are available for use with 10-32 and 6mm rack screws to accommodate slide out servers.

| Part #    | Description            |
|-----------|------------------------|
| CN1032-50 | 50 pc. 10-32 cage nuts |
| CN6MM-100 | 100 pc. 6MM cage nuts  |

## 12-24 and 6MM Rack Screws

Primarily used in telecommunications and data, these 5/8" long 12-24 and 6MM threaded screws are heat-treated to prevent head stripping. Finished in black, includes nylon washers.

| Part #   | Qty                                    |
|----------|--|
| HP-24    | 100 pc. 12-24 thread                   |
| HP24-500 | 500 pc. 12-24 thread in a reusable jar |
| HP-6MM   | 100 pc. 6MM Phillips head rack screws  |

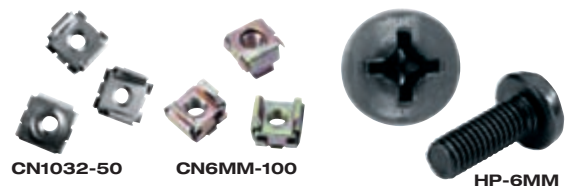

## Shoulder Washers

When used in conjunction with the pre-installed washers supplied on our screws, these black nylon shoulder washers will electrically isolate the equipment from the rackrails to help prevent ground loops. 100 piece count. NOTE: not for use with HPQ, HP-6MM and HP-24 screws

| Part # | Qty     |
|--------|---------|
| SW     | 100 pc. |



US PATENT #'S D517,404, D546,157

# Rack Accessories



## Micro Fiber Cleaning Cloths

Reusable micro fiber cleaning cloths are non-abrasive and lint free to keep anodized and other finishes on panels, drawers, RSH Series Custom Rackshelves and Plexiglass doors clean. Plexiglass version includes 2 oz. bottle of cleaner.

| Part #  | For Use On                    |
|---------|-------------------------------|
| PNL-CLN | panels, drawers, RSH Series   |
| PLX-CLN | plexi doors, includes cleaner |

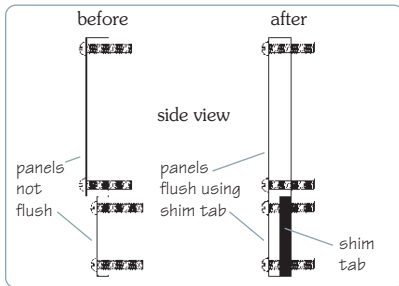

Shim Tab Application

## Shim Tabs

All faceplates can be flush with these handy shim tabs. 1/16" thick, they can be stacked to achieve desired thickness. Attaches with customer supplied double-stick tape.

| Part # | Fits    | Quantity |
|--------|---------|----------|
| ST1MP  | 1 space | 100 pc.  |
| ST2MP  | 2 space | 100 pc.  |
| ST3MP  | 3 space | 100 pc.  |

## Sony® Ears

With these ears, you can install Sony® TV tuner products in any 19" rack. Attach the ears with the supplied metric hardware, no unit modification required.

| Part #      | Fits                      | Finish                   |
|-------------|---------------------------|--------------------------|
| SONY EARS   | ST-72TV, ST-02TV, VPR-722 | black brushed & anodized |
| SONY EARS 2 | TU-1041U                  | black powder coat        |



## Rear Hanging Brackets

These rear hanging brackets fit any amplifier with rear ears and attach to rear rackrail to provide additional equipment support and feature unequal length mounting legs for versatility. Sold in pairs.

| Part # | Racking Height   |
|--------|------------------|
| RH-2   | 3 1/2" (2 space) |
| RH-3   | 5 1/4" (3 space) |
| RH-4   | 7" (4 space)     |

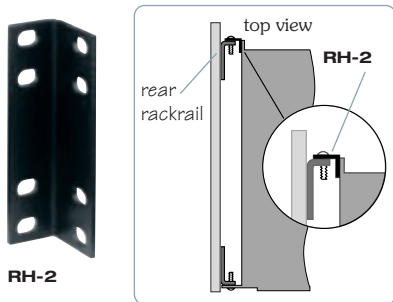
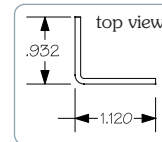

## RRF Rackrail

A&E SPEC. # 96-033

Measuring 1/8" thick, the all-steel RRF rackrail is threaded for 10-32 screws and is finished in a durable black e-coat finish. With EIA standard spacing, they are sold in pairs and designed for use with 19 1/8" wide rough openings. Durable black e-coat finish.

| Part # | Racking Height     | Part # | Racking Height     |
|--------|--------------------|--------|--------------------|
| RRF2   | 3 1/2" (2 space)   | RRF14  | 24 1/2" (14 space) |
| RRF4   | 7" (4 space)       | RRF16  | 28" (16 space)     |
| RRF6   | 10 1/2" (6 space)  | RRF18  | 31 1/2" (18 space) |
| RRF8   | 14" (8 space)      | RRF21  | 36 3/4" (21 space) |
| RRF10  | 17 1/2" (10 space) | RRF27  | 47 1/4" (27 space) |
| RRF12  | 21" (12 space)     | RRF45  | 78 3/4" (45 space) |

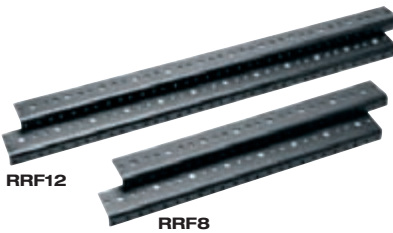

## Rack Ruler

No time for rackspace math? Use the Rack Ruler instead. It's a genuinely handy tape measure incremented in both rackspace (red) and inches (black) down to 1/32" scale. Measuring 1/2" wide by 96" (8 feet) long, its Mylar-coated retracting steel tape is housed in a tough ABS case with a thumb lock and belt clip. This is a rugged tool, not a toy.

| Part #  | Labeling On Back                        |
|---------|---|
| RULER   | audio tables, charts, and pinouts       |
| DARULER | data tables, charts, and contact wiring |

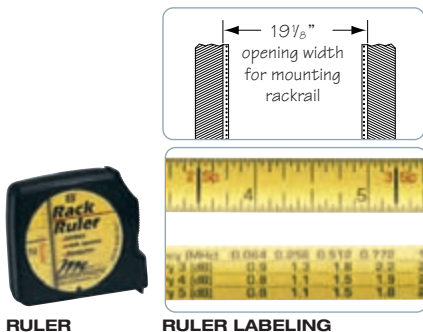

RULER

RULER LABELING



From a wealth of online resources to an award-winning customer support team, Middle Atlantic Products prides itself on the support it provides its customers to make product specification easy and convenient.

**Spec Clips™**

Spec Clips™ is an online technical tool that allows specifiers to quickly cut and paste individual model specifications for preparing project proposals.

**RackTools® 3.0**

This free CAD-compatible layout and specification software provides a drag-and-drop interface to create accurate rack elevation and plan view drawings, as well as purchase orders and quotes in minutes. No third-party software is required. **Visit [racktools.com](http://racktools.com) to download your copy today.**

**CAD Blocks**

CAD Blocks are offered for designers working in a CAD-only environment and provides elevation, rear, side and plan views for all welded, floor-standing enclosures and consoles. Available on the Master Reference CD, or by calling our technical support hotline at 800-266-7225.

**Educational Resources**

Middle Atlantic Products supports important industry initiatives on education and training by regularly holding classes and publishing educational white papers on issues such as thermal management, cable management, grounding and bonding and seismic certification.

**Thermal Calculator**

The Thermal Calculator is an effective and easy-to-use tool for calculating thermal requirements for enclosures of all sizes and applications, available at [middleatlantic.com](http://middleatlantic.com)

**Spec Sheets**

Architect's and Engineer's Specification Sheets provide detailed information and drawings in a convenient pdf format. 3 Part CSI MasterFormat Specification Sheets are also available. Available at [middleatlantic.com](http://middleatlantic.com) and on the Master Reference CD.

**Technical Support Hotline**

Staffed by a knowledgeable team of specialists and available to help with product, thermal, power and cable management questions, please call 800-266-7225.



**RackTools®  
Specification Software**

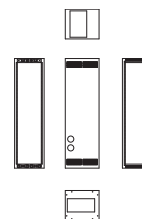

**CAD Blocks  
Drawing Tools**



**Technical  
White Papers**



**On Line  
Thermal Calculator**



**Product  
Specifications**



**Qualified  
Technical Support**

# Glossary

| Term  | Definition  |
|---|---|
| <b>3 Part Specifications:</b>                                       | A CSI MasterFormat 3 Part Spec is a document that contains all the product information and options needed when specifying products in the 3 part format. 3 Part Specifications are available on our website at <a href="http://middleatlantic.com">middleatlantic.com</a> and on our master reference CD.   |
| <b>A &amp; E Spec:</b>  | An A & E Spec, or Architects' and Engineers' Specification Sheet, is a document that contains all of the information, including dimensions, materials, and weight capacities, in the format needed when specifying products. Our Architect's and Engineer's Specification Sheets are available on our website at <a href="http://middleatlantic.com">middleatlantic.com</a> , on our catalog CD, or in printed form upon request.   |
| <b>American Society of Civil Engineers (ASCE):</b>                  | The American Society of Civil Engineers developed a set of standards that, when used in reference to our racks and enclosures, signifies that the piece of equipment will survive a seismic event to the specifications listed.   |
| <b>Anodize:</b>   | A finishing process used on aluminum. This process, when used on our products, includes 'brushing' to give an aesthetically-pleasing grained finish.  |
| <b>Bonding:</b>   | The permanent joining of metallic parts, likely to become energized, forming an electrically conductive path for a ground fault.  |
| <b>CAD Blocks:</b>  | AutoCAD® compatible, 1:1 scale product drawings embedded within select CAD A & E Spec files. CAD Blocks can be pasted directly into an AutoCAD® layout. Available on our master reference CD.   |
| <b>California Building Code (CBC):</b>                              | The California Building Code is a set of standards that, when used in reference to our racks and enclosures, signifies that the piece of equipment will survive a seismic event to the specifications listed.   |
| <b>CSA Listed:</b>  | The CSA Symbol signifies that a product meets or exceeds the standards that the Canadian Standards Association have set. This currently applies to select power products.   |
| <b>E-coat:</b>  | An electroplating process that, when used on our rackrail, guarantees that the threads do not become clogged.   |
| <b>EIA Compliant:</b>   | EIA is the 'Electronic Industries Alliance.' 'EIA compliant' states that the rack and accessories conform to the 310-D standards regarding the rackrail, panel sizes, dimensions, etc.  |
| <b>Ganging:</b>   | When two or more racks are connected together, side-by-side. This is done in installations when multiple racks are permanently installed, facilitating cabling between racks. Also referred to as a multi-bay installation.   |
| <b>Grounding:</b>   | The intentional connection of electrical equipment to a grounding conductor for safety.   |
| <b>International Building Code (IBC):</b>                           | The International Building Code is a set of standards that, when used in reference to our racks and enclosures, signifies that the piece of equipment will survive a seismic event to the specifications listed.  |
| <b>Isolated Ground:</b>   | Also referred to as a "Technical Ground," this originates only at the point where the ground and neutral are bonded together. Isolated grounding conductors must be insulated & not be bonded to metallic building structures, junction boxes & breaker panels and terminate only at the equipment being served by the isolated ground circuit.   |
| <b>KO:</b>  | KO is short for 'Knockout,' and applies to the knockouts that have been provided in most of our racks for electrical connections, cable pass-through and also for UHF/VHF antennas. One type of knockout consists of punched indentations in equipment cabinets, which can be easily knocked out using a screwdriver or other similar tool to create one of two different sized openings for running low-voltage cable, electrical conduit, connectors, etc. Another type of knockout is produced by a laser and produces smooth edges that are friendly to cables and contractors. |
| <b>MOV Surge and Spike Protection:</b>                              | MOV (Metal Oxide Varistor) is an electrical component that protects electrical equipment in the event of an electrical surge or spike.  |
| <b>National Electrical Code (NEC):</b>                              | The National Electrical Code is a set of safety standards for electrical work. When used in reference to our racks and enclosures it specifies the method in which an enclosure is to be grounded and bonded.   |
| <b>National Fire Protection Agency (NFPA):</b>                      | The National Fire Protection Agency developed a set of standards that, when used in reference to our racks and enclosures, signifies that the piece of equipment will survive a seismic event to the specifications listed.   |
| <b>Network Equipment Building System (NEBS):</b>                    | The Network Equipment Building System is a set of standards that, when used in reference to our racks and enclosures, specifies the method in which an enclosure is to be grounded and bonded.  |
| <b>Office of Statewide Health Planning and Development (OSHDP):</b> | OSHDP refers to a set of standards that, when used in references to our racks and enclosures, signifies that the piece of equipment will survive a seismic event to the specifications listed.  |
| <b>Powder Coat:</b>   | Powder coat is an epoxy based finish that is applied electrostatically and then baked to cure the finish. Powder coating is an environmentally friendly process that does not release any harsh chemicals into the water or air. Powder coat is scratch-resistant and protects the materials from corrosion.  |
| <b>Rackspace (Rack unit, RU, space):</b>                            | A rackspace is a 1.75" vertical increment based on EIA/TIA standards and is how all 19" wide rackmount components are measured in terms of height. It is the only measure common to the metric and English systems. Applies also to 23" mounting widths.  |
| <b>RackTools®:</b>  | RackTools® is a free layout and specification software package produced by Middle Atlantic Products. Containing our complete product line, RackTools® is user-friendly and does not require any third party software to generate drawings, purchase orders and quotes quickly and easily. Please visit <a href="http://racktools.com">racktools.com</a> for more information and to download your free copy.  |
| <b>Seismic Certified:</b>   | A seismic certification signifies that our rack has been certified to an established standard to survive a seismic event and remain functional. A seismically certified rack is one component of a seismically rated installation.  |
| <b>Spec Clips™:</b>   | Customizable specification clips that can be copied and pasted directly into project specifications. Please visit <a href="http://middleatlantic.com">middleatlantic.com</a> to access this free tool.  |
| <b>Stand-Alone:</b>   | Racks or power modules that are used alone, i.e. WRK-SA Series stand-alone enclosure and 30 amp stand-alone power modules.  |
| <b>TIA Compliant:</b>   | TIA is the 'Telecommunications Industry Association.' TIA compliant states that the rack and accessories conform to standards regarding the rackrail, panel sizes, dimensions, etc.   |
| <b>UL Listed:</b>   | The UL Listed Symbol signifies that a product has been tested and certified by UL (Underwriters Laboratories) to meet or exceed their safety standards. This applies to many of our products, including power products, racks and enclosures and their accessories. Many of our products are UL Listed in both the US and Canada.   |
| <b>Uniform Building Code (UBC):</b>                                 | The Uniform Building Code is a set of standards that, when used in reference to our racks and enclosures, signifies that the piece of equipment will survive a seismic event to the specifications listed.  |
| <b>Useable Depth:</b>   | On racks the useable depth is based on the maximum front to rear rail depth, with the exception of wall racks, where the open space in the backpan is considered part of the useable depth. On a rackshelf, the useable depth is the maximum depth of the component that can fit on the shelf.  |

**Middle Atlantic Products Inc., an ISO 9001:2000 registered company,** manufactures engineered solutions for all integrated electronic systems. Our customer-first philosophy places special emphasis on quality, service and meeting the everyday working needs of our customers. All of our products are designed from the installer's point of view. From built-in cable management on our racks and enclosures to pre-installed washers on our rack screws, we look at all aspects of an installation to find ways to save time and simplify the job.

Some of the benefits of doing business with Middle Atlantic Products include:

- Always in stock policy, with factory warehousing in 5 locations throughout North America – product where you need it, when you need it
- Comprehensive offering of mounting, power distribution, cable management, and thermal management products, as well as all needed accessories to complete the installation quickly, and more reliably
- Friendly, knowledgeable support staff, available from 8AM to 8PM EST
- Extensive US manufacturing capabilities, providing quick turnaround for large orders
- Regional delivery programs, utilizing our own trucks, ensuring damage free service
- Regulatory compliance to ensure trouble free approvals, including UL, ROHS, and Seismic
- Broad suite of technical support tools, including phone support, A&Es, CAD drawings, CSI MasterFormat 3 Part Specs, Spec Clips™, RackTools® system layout software and RackFinder™ enclosure selection tools
- White papers and other training classes provide valuable education on critical topics including Grounding and Bonding, and Thermal Management



Fairfield, NJ  
Corporate Headquarters



Extensive US  
Manufacturing Capabilities



Helpful Support Staff  
is Available Daily From  
8AM - 8PM EST

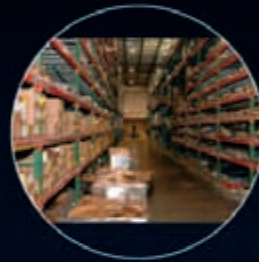

Five Fully Stocked  
Warehouses in North  
America Provide Product  
Where it is Needed



Fleet of Regional Trucks  
Deliver Throughout North  
America

#### ENVIRONMENTAL POLICY

Our environmental policy is a continual cycle of planning, implementing, reviewing and improving processes and actions to meet our environmental obligations. Specific goals of resource efficiency and pollution prevention are actualized by our corporate environmental objectives:

- To comply with or exceed applicable environmental laws, regulations and standards, including RoHS (Restriction of Hazardous Substances).
- To conserve resources by reusing and recycling materials including steel, cardboard, paper, office supplies and computer equipment.
- To maintain quality of life in our community by utilizing state-of-the-art environmentally friendly manufacturing equipment that requires no hazardous materials, ensuring that nothing harmful is expelled into the air or water supply.



#### Corporate Headquarters

Corporate Voice 800-266-7225 • Fax 973-839-1976  
International Voice +1 973 839 1011 • Fax +1 973 831 4982  
middleatlantic.com • info@middleatlantic.com

#### Middle Atlantic Canada

Voice 613-836-2501 • Fax 613-836-2690  
middleatlantic.ca • customerservicecanada@middleatlantic.ca

#### Factory Distribution Centers

USA: NJ • CA • IL CANADA: ON • BC



**ISO 9001 : 2000  
REGISTERED**

ISO 9001:2000 registration ensures a world-class quality management system that provides the assurance that our customers will receive the same consistently high quality products and service they have come to rely on and expect from Middle Atlantic Products, Inc.

