

CONNECTOR SIZE	TOLERANCES						
	B	C	E	K DIA .	L	N	O . D .
- 10 C	±.04	±.04	±.02	±.02	±.06	±.03	±.01
8 C - 25	±.06	±.04	±.02	±.02	±.09	±.03	±.01
26 - 34	±.08	±.04	±.02	±.02	±.12	±.03	±.01
35 A N D U P	±.09	±.06	±.02	±.02	±.15	±.06	±.01

REV	DATE	DESCRIPTION	ECO	BY	CHK.
D	03/29/2016	CATALOG NUMBERS UPDATED IN SHEET-14	43089	CV	MB

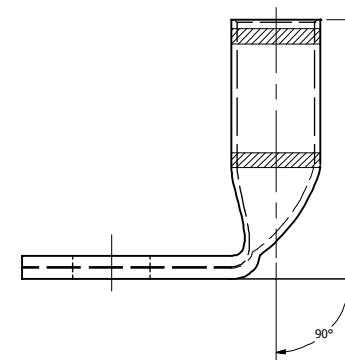
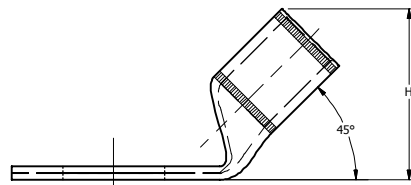
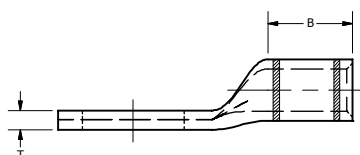
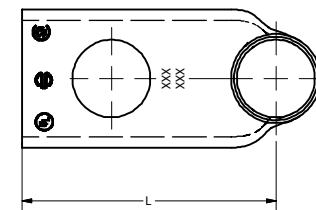
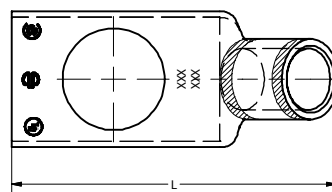
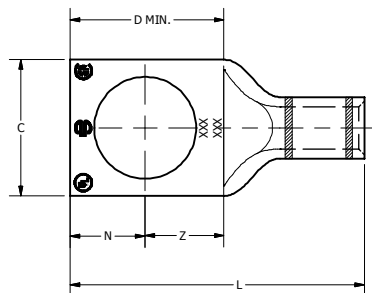

FIG. 1

FIG. 2

FIG. 3

NOTES:

1. MATERIAL: COPPER TUBING.
2. FINISH: TIN PLATED UNLESS OTHERWISE SPECIFIED.  
 SUFFIX NK = NICKEL PLATING.  
 SUFFIX SV = SILVER PLATING.  
 SUFFIX BR = NO PLATING.
3. CATALOG# PT6515 ADAPTOR IS REQUIRED TO USE "U" DIES IN Y45 SERIES TOOLS.
4. CATALOG# PUADP-1 ADAPTOR IS REQUIRED TO USE "U" DIES IN Y46 SERIES TOOLS.
5. PERMANENT DIE IN TOOLING.
6. DIMENSIONS IN BRACKETS [ ] ARE IN MILLIMETERS ROUNDED OFF TO THE NEAREST MILLIMETER, UNLESS OTHERWISE SPECIFIED AND ARE FOR REFERENCE ONLY.
7. CONNECTORS ARE UL LISTED: UNDRILLED VERSIONS ARE NOT UL LISTED.
8. CONNECTORS ARE CSA CERTIFIED: UNDRILLED VERSIONS ARE NOT CSA CERTIFIED.
9. FOR UNDRILLED VERSIONS ADD SUFFIX "U" TO END OF CATALOG NUMBER.  
 FOR UNDRILLED VERSIONS, USE D MIN = N MAX. + Z MIN.
10. THESE CATALOG NUMBERS CANNOT BE INSTALLED WITH U8CRT DIE.
11. THESE CATALOG NUMBERS CANNOT BE INSTALLED WITH Y45 OR Y46 TOOLING.

TO ORDER BURNDY® PRODUCTS CALL		HYLUG™	
UNITED STATES 1-800-346-4175 (LONDONDERRY, NH)		ITEM NO: N/A	
CANADA: 1-800-361-6975 (QUEBEC) 1-800-387-6487 (ALL OTHER PROVINCES)		CAT. NO: YAGLTCFX, YAGL NTFX	
FOR PRODUCT INFO: <a href="http://www.burndy.com">http://www.burndy.com</a>		DRAWN BY: M. RAMESH 3/29/2012	
		CHECKER: R. ROMAN 4/28/2012	
		DSN APRVL: R. WATTS 4/27/2012	
		QA APRVL: JSYLVA 4/30/2012	
		MKT APRVL:	
		PROD FAM:	
		PROJECT #: CM&R	
		SIZE: C	
		DRAWING NO: 50000268	
		REV: D	
		REL LEVEL: Released	
		SHEET 1 OF 19	









CATALOG NO.	CONDUCTOR			BOLT SIZE	FIG NO.	DIMENSIONS										BURNDY® INSTALLATION TOOLING (# CRIMPS)																											
	FLEX	CODE (AWG)	NAVY			B	C	H	K	L	N	O.D.	T REF	Z MIN.	DIE INDEX	COLOR CODE	MECHANICAL		HYDRAULIC				DIELESS (# CRIMPS)	WIRE STRIP LENGTH																			
																	MD6	OUR840	PATMD6 YA500CTH SPAT600	Y750, Y35 Y39 PAT750, Y35 Y39	Y46, PAT46	Y45																					
YAG1CLTC10FX	# 1 FLEX CLASS G,H,I,K,M DLO (175/24) (225/24)	# 1 AWG	75	# 10 [M 5]	0.62 [16]	.75 [19]	---	.21	1.54 [39]	.25	.51 [13]	.12 [3]	.36 [9]	11 OR 375	GREEN	W1CRT1(1) X1CRT1(1) W1CVT1(1)	X1CRT1(1) W1CVT1(1)	W1CRT1(1) X1CRT1(1) W1CVT1(1)	U1CRT1 (1)	U1CRT1 (1)	U1CRT1 (1)	HYDRAULIC: Y644(1) Y81KFT(1) Y4PC834(1) PAT644(1) PAT81KFT(1)	11/16"																				
YAG1CLTC10FX45							1.11 [28]	1.53 [39]	[6]	.27 [7]																																	
YAG1CLTC10FX90							1.22 [31]	.88 [22]	[6]																																		
YAG1CLTC14FX				1/4 [M 6]			---	1.67 [42]	.31 [8]	.33 [8]																																	
YAG1CLTC14FX45							1.11 [28]	.27 [7]																																	1.65 [42]	[8]	
YAG1CLTC14FX90							1.22 [31]																																		1.00 [25]	[8]	
YAG1CLTC516FX				5/16 [M 8]			---	1.73 [44]	.34 [9]	.36 [9]																																	
YAG1CLTC516FX45							1.11 [28]	.33 [8]																																		1.72 [44]	[9]
YAG1CLTC516FX90							1.22 [31]																																			1.07 [27]	[9]
YAG1CLTC38FX				3/8 [M 10]			---	1.86 [47]	.41 [10]	.42 [11]																																	
YAG1CLTC38FX45							1.11 [28]	.41 [10]																																		1.84 [46]	[10]
YAG1CLTC38FX90							1.22 [31]																																			1.19 [30]	[10]
YAG1CLTC12FX				1/2 [M 12]			---	2.11 [54]	.53 [13]	.55 [14]																																	
YAG1CLTC12FX45							1.11 [28]	.53 [13]																																		2.09 [53]	[13]
YAG1CLTC12FX90							1.22 [31]																																			1.44 [37]	[13]

SEE SHEET 1 OF 19 FOR NOTES

TO ORDER BURNDY® PRODUCTS CALL		HYLUG™	
UNITED STATES 1-800-346-4175 (LONDONDERRY, NH)		ITEM NO: N/A	
CANADA: 1-800-361-6975 (QUEBEC)		CAT. NO: YAG1CLTC-FX(TABLE)	
1-800-387-6487 (ALL OTHER PROVINCES)		DRAWN BY: M. RAMESH 3/29/2012	
FOR PRODUCT INFO: <a href="http://www.burndy.com">http://www.burndy.com</a>		CHECKER: R. ROMAN 4/28/2012	
		DSN APRVL: R. ROMAN 4/27/2012	
		MFG APRVL: T. WATTS 4/27/2012	
		QA APRVL: J. SYLVIA 4/30/2012	
		MKT APRVL:	
		PROD FAM:	
		PROJECT #: CM&R	
		DOCUMENT TYPE: SALES	
		REL LEVEL: Released	
		DRAWING NO	
		50000268	
		REV	
		D	
		SHEET 6 OF 19	

CATALOG NO.	CONDUCTOR			BOLT SIZE	FIG NO.	DIMENSIONS										BURNDY® INSTALLATION TOOLING (# CRIMPS)							
	FLEX	CODE (AWG)	NAVY			B	C	H	K	L	N	O.D.	T REF	Z MIN.	DIE INDEX	COLOR CODE	MECHANICAL		HYDRAULIC			DIELESS (# CRIMPS)	WIRE STRIP LENGTH
																	MD6	OUR840	Y750HS, Y35 Y39, PAT750	Y46<4> PAT46	Y45<3>		
YAG25LTC14FX	1/0 FLEX CLASS G,H,I,K,M DLO (275/24)	1/0 AWG	100	1/4 [M6]	1	.69 [18]	.83 [21]	---	1.77 [45]	.31 [8]	.33 [8]	12 OR 348	PINK	W25RT X25RT W25VT (2)	X25RT W25VT (2)	U25RT (1)	U25RT (1)	U25RT (1)	HYDRAULIC: Y644 (1) Y8 1KFT (1) Y4PC834 (1) PAT644 (1) PAT8 1KFT (1)	11/16"			
YAG25LTC14FXNK <2>								---	---														
YAG25LTC14FXBR <2>								.27 [7]	---														
YAG25LTC14FX45								1.22 [31]	1.73 [44]														
YAG25LTC14FX90								1.33 [34]	1.03 [26]														
YAG25LTC14FX90NK <2>								---	---														
YAG25LTC516FX				5/16 [M8]	2	---	1.84 [47]	.34 [9]	.56 [14]	.12 [3]	.36 [9]												
YAG25LTC38FX45						1.22 [31]	.33 [8]					1.79 [45]											
YAG25LTC38FX90						1.33 [34]	1.09 [28]																
YAG25LTC12FX				3/8 [M10]	2	---	1.96 [50]	.41 [10]	.42 [11]														
YAG25LTC12FX45						1.22 [31]	.40 [10]			1.92 [49]													
YAG25LTC38FX90						1.33 [34]	1.22 [31]																
YAG25LTC12FX				1/2 [M12]	2	---	2.21 [56]	.53 [13]	0.55 [14]														
YAG25LTC12FX45						1.22 [31]	.53 [13]			2.17 [55]													
YAG25LTC12FX90						1.33 [34]	1.47 [37]																

SEE SHEET 1 OF 19 FOR NOTES

TO ORDER BURNDY® PRODUCTS CALL		HYLUG™	
UNITED STATES 1-800-346-4175 (LONDONDERRY, NH)		ITEM NO: N/A	
CANADA: 1-800-361-6975 (QUEBEC)		CAT. NO: YAG25LTC--FX (TABLE)	
1-800-387-6487 (ALL OTHER PROVINCES)		DRAWN BY: M.RAMESH 3/29/2012	
FOR PRODUCT INFO: <a href="http://www.burndy.com">http://www.burndy.com</a>		CHECKER: R.ROMAN 4/28/2012	
		DSN APRVL: R.ROMAN 4/27/2012	
		MFG APRVL: T.WATTS 4/27/2012	
		QA APRVL: J.SYLVIA 4/30/2012	
		MKT APRVL:	
		PROD FAM:	
		DRAWING NO	
		REV	
		PROJECT #: CM&R	
		SIZE	
		50000268	
		DOCUMENT TYPE: SALES	
		C	
		SHEET 7 OF 19	
		D	







CATALOG NO.	CONDUCTOR			BOLT SIZE	FIG NO.	DIMENSIONS										INSTALLATION TOOLING (# CRIMPS)																					
	FLEX	CODE (AWG)	NAVY			B	C	H	K	L	N	O.D.	T REF	Z MIN.	DIE INDEX	COLOR CODE	MECHANICAL		HYDRAULIC			DIELESS (# CRIMPS)	WIRE STRIP LENGTH														
																	MD6	OUR840	Y750, PAT750 Y35, Y39	Y46 PAT46	Y45																
YAG28LTC14FX	4/0 FLEX CLASS G,H,I,K,M DLO (550/24)	4/0 AWG	200	1/4 [M 6]	1.03 [26]	1.14 [29]	---	.27	2.26 [57]	.31	.77 [20]	.15 [4]	15	PURPLE	W28RT (2) X28RT (3) W28VT(2)	X28RT (3) W28VT (2)	U28RT (1)	U28RT (1)	U28RT (1)	HYDRAULIC: Y644(1) Y81KFT(1) Y4PC834 (1) PAT644 (1) PAT81KFT (1)	1'-1/16"																
YAG28LTC14FX45							1.72 [44]	2.13 [54]	[8]	.33 [8]																											
YAG28LTC14FX90							1.87 [47]	1.14 [29]																													
YAG28LTC516FX							---	2.32 [59]																													
YAG28LTC516FX45							1.72 [44]	.33 [8]	2.19 [56]	.34 [9]												.36 [9]															
YAG28LTC516FX90							1.87 [47]		1.21 [31]																												
YAG28LTC38FX				3/8 [M 10]	1.03 [26]	1.14 [29]	---	.40	2.45 [62]	.41	.77 [20]	.15 [4]	15	PURPLE	W28RT (2) X28RT (3) W28VT(2)	X28RT (3) W28VT (2)	U28RT (1)	U28RT (1)	U28RT (1)			HYDRAULIC: Y644(1) Y81KFT(1) Y4PC834 (1) PAT644 (1) PAT81KFT (1)	1'-1/16"														
YAG28LTC38FX45							1.72 [44]	2.32 [59]	[10]	.42 [11]																											
YAG28LTC38FX90							1.87 [47]	1.33 [34]																													
YAG28LTC12FX							1/2 [M 12]	1.03 [26]	1.14 [29]	---														.53	2.70 [69]	.53	.77 [20]	.15 [4]	15	PURPLE	W28RT (2) X28RT (3) W28VT(2)	X28RT (3) W28VT (2)	U28RT (1)	U28RT (1)	U28RT (1)	HYDRAULIC: Y644(1) Y81KFT(1) Y4PC834 (1) PAT644 (1) PAT81KFT (1)	1'-1/16"
YAG28LTC12FX45										1.72 [44]														2.57 [65]	[13]	.55 [14]											
YAG28LTC12FX90										1.87 [47]														1.58 [40]													
YAG28LTC58FX				5/8 [M 16]	1.03 [26]	1.14 [29]	---	.69	2.95 [75]	.66	.77 [20]	.15 [4]	15	PURPLE	W28RT (2) X28RT (3) W28VT(2)	X28RT (3) W28VT (2)	U28RT (1)	U28RT (1)	U28RT (1)					HYDRAULIC: Y644(1) Y81KFT(1) Y4PC834 (1) PAT644 (1) PAT81KFT (1)	1'-1/16"												
YAG28LTC58FX45							1.72 [44]	2.82 [72]	[17]	.67 [17]																											
YAG28LTC58FX90							1.87 [47]	1.83 [46]																													
YAG28LTC34FX				3/4 [M 20]	1.03 [26]	1.14 [29]	---	.81	3.14 [80]	.75	.77 [20]	.15 [4]	15	PURPLE	W28RT (2) X28RT (3) W28VT(2)	X28RT (3) W28VT (2)	U28RT (1)	U28RT (1)	U28RT (1)							HYDRAULIC: Y644(1) Y81KFT(1) Y4PC834 (1) PAT644 (1) PAT81KFT (1)	1'-1/16"										
YAG28LTC34FX45							1.72 [44]	3.00 [76]	[19]																												
YAG28LTC34FX90							1.87 [47]	2.02 [51]																													

SEE SHEET 1 OF 19 FOR NOTES

TO ORDER BURNDY® PRODUCTS CALL		HYLUG™	
UNITED STATES 1-800-346-4175 (LONDONDERRY, NH)		ITEM NO: N/A	
CANADA: 1-800-361-6975 (QUEBEC)		CAT. NO: YAG28LTC--FX (TABLE)	
1-800-387-6487 (ALL OTHER PROVINCES)		DRAWN BY: M. RAMESH 3/29/2012	
FOR PRODUCT INFO: <a href="http://www.burndy.com">http://www.burndy.com</a>		CHECKER: R. ROMAN 4/28/2012	
		DSN APRVL: R. ROMAN 4/27/2012	
		MFG APRVL: T. WATTS 4/27/2012	
		QA APRVL: J. SYLVIA 4/30/2012	
		MKT APRVL:	
		PROD FAM:	
		PROJECT #: CM&R	
		SIZE	
		DRAWING NO	
		50000268	
		REV	
		D	
		DOCUMENT TYPE: SALES	
		REL LEVEL: Released	
		SHEET 10 OF 19	

CATALOG NO.	CONDUCTOR			BOLT SIZE	FIG NO.	DIMENSIONS										BURNDY® INSTALLATION TOOLING (# CRIMPS)													
	FLEX	CODE (AWG)	NAVY			B	C	H	K	L	N	O.D.	T REF	Z MIN.	DIE INDEX	COLOR CODE	MECHANICAL	HYDRAULIC			DIELESS (# CRIMPS)	WIRE STRIP LENGTH							
																	MD6	Y750, PAT750 Y35 Y39	Y46 PAT46	Y45									
YAG30LTC516FX	250 FLEX CLASS G; 259 STR CLASS H; 427 STR	---	---	5/16 [M 8]	1.03 [26]	1.02 [30]	---		2.34 [60]																				
YAG30LTC516FX45							1.77 [45]	.33 [8]	2.25 [57]	.34 [9]						.36 [9]													
YAG30LTC516FX90							1.92 [49]		1.24 [63]																				
YAG30LTC38FX				3/8 [M 10]								---		2.47 [63]															
YAG30LTC38FX45							1.77 [45]	.40 [10]	2.37 [60]	.41 [10]					.42 [11]														
YAG30LTC38FX90							1.92 [49]		1.36 [35]																				
YAG30LTC12FX				1/2 [M 12]								---		2.72 [69]															
YAG30LTC12FX45							1.77 [45]	.53 [13]	2.62 [67]	.53 [13]					.81 [21]	.16 [4]	.55 [14]	16	YELLOW	W29VT (2)	U29RT (1)	U29RT (1)	U29RT (1)						
YAG30LTC12FX90							1.92 [49]		1.61 [41]																				
YAG30LTC58FX				5/8 [M 16]								---		2.97 [75]															
YAG30LTC58FX45							1.77 [45]	.69 [17]	2.87 [73]	.66 [17]							.67 [17]												
YAG30LTC58FX90							1.92 [49]		1.86 [47]																				
YAG30LTC34FX				3/4 [M 20]								---		3.16 [80]															
YAG30LTC34FX45							1.77 [45]	.81 [21]	3.06 [78]	.75 [19]							.77 [19]												
YAG30LTC34FX90							1.92 [49]		2.05 [52]																				

SEE SHEET 1 OF 19 FOR NOTES

TO ORDER BURNDY® PRODUCTS CALL		HYLUG™	
UNITED STATES 1-800-346-4175 (LONDONDERRY, NH)		ITEM NO: N/A	
CANADA: 1-800-361-6975 (QUEBEC) 1-800-387-6487 (ALL OTHER PROVINCES)		CAT. NO: YAG30LTC--FX (TABLE)	
FOR PRODUCT INFO: <a href="http://www.burndy.com">http://www.burndy.com</a>		DRAWN BY: M. RAMESH 3/29/2012	
		CHECKER: R. ROMAN 4/28/2012	
		DSN APRVL: R. ROMAN 4/27/2012	
		MFG APRVL: T. WATTS 4/27/2012	
		QA APRVL: J. SYLVIA 4/30/2012	
		MKT APRVL:	
		PROD FAM:	
		PROJECT #: CM&R	
		DOCUMENT TYPE: SALES	
		REL LEVEL: Released	
		DRAWING NO	
		50000268	
		SHEET 11 OF 19	
		REV	
		D	

CATALOG NO.	CONDUCTOR			BOLT SIZE	FIG NO.	DIMENSIONS										INSTALLATION TOOLING (# CRIMPS)						
	FLEX	CODE (AWG)	NAVY			B	C	H	K	L	N	O.D.	T REF	Z MIN.	DIE INDEX	COLOR CODE	MECHANICAL	HYDRAULIC			DIELESS (# CRIMPS)	WIRE STRIP LENGTH
																	MD6	Y750, PAT750 Y35 Y39	Y46 PAT46	Y45		
YAG31LTC14FX	250 FLEX 637/24 CLASS I,K,M	---	---	1/4 [M 6]	1.06 [27]	1.29 [33]	---	.27	2.35 [60]	.31	.88 [22]	.18 [4]	.33 [8]	17 OR 298	WHITE	W30VT (2)	U30RT (2)	U30RT (2)	U30RT (2)	HYDRAULIC: Y644M (1) Y81KFT (1) Y4PC834 (1) PAT644 (1) PAT81KFT (1)	1-1/8"	
YAG31LTC14FX45							187 [47]	2.26 [57]	.36 [9]													
YAG31LTC14FX90							2.01 [51]	1.19 [30]														
YAG31LTC516FX							---	2.41 [61]	.42 [11]													
YAG31LTC516FX45							187 [47]	2.32 [59]														
YAG31LTC516FX90							2.01 [51]	1.27 [32]														
YAG31LTC38FX				3/8 [M 10]	---	2.53 [64]	.41 [10]															
YAG31LTC38FX45					187 [47]	2.45 [62]																
YAG31LTC38FX90					2.01 [51]	1.40 [36]																
YAG31LNT12FX				1/2 [M 12]	---	2.78 [71]	.53 [13]															
YAG31LNT12FX45					187 [47]	2.70 [69]																
YAG31LNT12FX90					2.01 [51]	1.65 [42]																
YAG31LTC12FX				1/2 [M 12]	---	2.78 [71]	.53 [13]															
YAG31LTC12FX45					187 [47]	2.70 [69]																
YAG31LTC12FX90					2.01 [51]	1.65 [42]																
YAG31LTC58FX				5/8 [M 16]	---	3.03 [77]	.66 [17]															
YAG31LTC58FX45					187 [47]	2.95 [75]																
YAG31LTC58FX90					2.01 [51]	1.90 [48]																
YAG31LTC34FX				3/4 [M 20]	---	3.22 [82]	.75 [19]															
YAG31LTC34FX45					187 [47]	3.13 [80]																
YAG31LTC34FX90	2.01 [51]	2.09 [53]																				

SEE SHEET 1 OF 19 FOR NOTES

TO ORDER BURNDY® PRODUCTS CALL

UNITED STATES  
1-800-346-4175 (LONDONDERRY, NH)

CANADA:  
1-800-361-6975 (QUEBEC)  
1-800-387-6487 (ALL OTHER PROVINCES)

FOR PRODUCT INFO: <http://www.burndy.com>

HYLUG™	
ITEM NO: N/A	
CAT. NO: YAG31LTC--FX (TABLE)	
DRAWN BY: M.RAMESH	3/29/2012
CHECKER: R.ROMAN	4/28/2012
DSN APRVL: R.ROMAN	4/27/2012
MFG APRVL: T.WATTS	4/27/2012
QA APRVL: J.SYLVIA	4/30/2012
MKT APRVL:	
PROD FAM:	
PROJECT #: CM&R	SIZE
DOCUMENT TYPE: SALES	50000268
REL LEVEL: Released	C
DRAWING NO	REV
50000268	D
SHEET 12 OF 19	



CATALOG NO.	CONDUCTOR			BOLT SIZE	FIG. NO.	DIMENSIONS										BURNDY® INSTALLATION TOOLING (# CRIMPS)						
	FLEX	CODE (AWG)	NAVY			B	C	H	K	L	N	O.D.	T REF	Z MIN.	DIE INDEX	COLOR CODE	MECHANICAL		HYDRAULIC		DIELESS (# CRIMPS)	WIRE STRIP LENGTH
																	MD6	Y750, PAT750 Y35, Y39	Y46<4> PAT46	Y45<3>		
YAG32LNT38FX	300 FLEX CLASS G, H, I, K, M 313.1DLO (775/24)	---	---	3/8 [M 10]	1	---	.40 [10]	.96 [24]	2.72 [69]	.41 [10]	.95 [24]	.19 [5]	18 OR 324	RED	W31VT (2)	U31RT (2)	U31RT (2)	U31RT (2)	HYDRAULIC: Y644(1) Y81KFT(1) Y4PC834(1) PAT644 (1) PAT81KFT (1)	1-1/4"		
YAG32LNT38FX45					2	2.06 [52]			2.61 [66]													
YAG32LNT38FX90					3	2.23 [57]			1.45 [37]													
YAG32LTC38FX					1	---	2.72 [69]															
YAG32LTC38FX45					2	2.06 [52]	2.61 [66]															
YAG32LTC38FX90					3	2.23 [57]	1.45 [37]															
YAG32LTC12FX				1/2 [M 12]	1	---	2.97 [75]	1.19 [30]	1.40 [36]	.53 [13]	.53 [13]	.55 [14]										
YAG32LTC12FX45					2	2.06 [52]	2.86 [73]															
YAG32LTC12FX90					3	2.23 [57]	1.70 [43]															
YAG32LTC58FX				5/8 [M 16]	1	---	3.22 [82]	.66 [17]	.69 [17]	.66 [17]	.67 [17]											
YAG32LTC58FX45					2	2.06 [52]	3.11 [79]															
YAG32LTC58FX90					3	2.23 [57]	1.95 [49]															

SEE SHEET 1 OF 19 FOR NOTES

TO ORDER BURNDY® PRODUCTS CALL  UNITED STATES 1-800-346-4175 (LONDONDERRY, NH)  CANADA: 1-800-361-6975 (QUEBEC) 1-800-387-6487 (ALL OTHER PROVINCES)  FOR PRODUCT INFO: <a href="http://www.burndy.com">http://www.burndy.com</a>	HYLUG™		
	ITEM NO: N/A		
	CAT. NO: YAG32L-- (TABLE)		
	DRAWN BY: M. RAMESH	3/29/2012	
	CHECKER: R. ROMAN	4/28/2012	
	DSN APRVL: R. ROMAN	4/27/2012	
	MFG APRVL: T. WATTS	4/27/2012	
	QA APRVL: J. SYLVIA	4/30/2012	
	PROJ FAM:	DRAWING NO	REV
	PROJECT #: CM&R	SIZE	50000268
DOCUMENT TYPE: SALES	C	D	
REL LEVEL: Released	SHEET 13 OF 19		

CATALOG NO.	CONDUCTOR			BOLT SIZE	FIG. NO.	DIMENSIONS										BURNDY® INSTALLATION TOOLING (# CRIMPS)							
	FLEX	CODE (AWG)	NAVY			B	C	H	K	L	N	O.D.	T REF	Z MIN.	DIE INDEX	COLOR CODE	MECHANICAL		HYDRAULIC			DIELESS (# CRIMPS)	WIRE STRIP LENGTH
																	MD6	Y750, PAT750 Y35, Y39	Y46 PAT46	Y45			
YAG34LTC516FX	350 FLEX CLASS G,H,I,K,M 373.3DLO(925/2 4)	---	---	5/16 [M 8]	1.27 [32]	1.55 [39]	---	.33 [8]	2.78 [71]	.34 [9]	1.06 [27]	.23 [6]	19 OR 470	BLUE	W32VT(2)	U32RT (2)	U32RT (2)	U32RT (2)	HYDRAULIC: Y644 (1) Y81KFT (1) Y4PC834 (1) PAT644 (1) PAT81KFT (1)	1-5/16"			
YAG34LTC516FX45							2		2.27 [58]												2.69 [68]	.36 [9]	
YAG34LTC516FX90							3		2.45 [62]												1.40 [36]		
YAG34LTC38FX				3/8 [M 10]			1	---	2.91 [74]	.41 [10]											.42 [11]		
YAG34LTC38FX45							2	2.27 [58]	.40 [10]													2.81 [71]	
YAG34LTC38FX90							3	2.45 [62]	1.52 [39]														
YAG34LTC12FX				1/2 [M 12]			1	---	3.16 [80]	.53 [13]											.55 [14]		
YAG34LTC12FX45							2	2.27 [58]	.53 [13]													3.06 [77]	
YAG34LTC12FX90							3	2.45 [62]	1.77 [45]														
YAG34LTC58FX				5/8 [M 16]			1	---	3.41 [87]	.66 [17]											.67 [17]		
YAG34LTC58FX45							2	2.27 [58]	.69 [17]													3.31 [84]	
YAG34LTC58FX90							3	2.45 [62]	2.02 [52]														

SEE SHEET 1 OF 19 FOR NOTES

TO ORDER BURNDY® PRODUCTS CALL		HYLUG™	
UNITED STATES 1-800-346-4175 (LONDONDERRY, NH)		ITEM NO: N/A	
CANADA: 1-800-361-6975 (QUEBEC)		CAT. NO: YAG34LTC--FX (TABLE)	
1-800-387-6487 (ALL OTHER PROVINCES)		DRAWN BY: M. RAMESH 3/29/2012	
FOR PRODUCT INFO: <a href="http://www.burndy.com">http://www.burndy.com</a>		CHECKER: R. ROMAN 4/28/2012	
		DSN APRVL: R. ROMAN 4/27/2012	
		MFG APRVL: T. WATTS 4/27/2012	
		QA APRVL: J. SYLVIA 4/30/2012	
		MKT APRVL:	
PROD FAM:	PROJECT #:	SIZE:	DRAWING NO:
	CM&R	C	50000268
DOCUMENT TYPE:	REL LEVEL:	Released	SHEET 14 OF 19
			REV: D

CATALOG NO.	CONDUCTOR			BOLT SIZE	FIG. NO.	DIMENSIONS										INSTALLATION TOOLING (# CRIMPS)					
	FLEX	CODE (AWG)	NAVY			B	C	H	K	L	N	O.D.	T REF.	Z MIN.	DIE INDEX	COLOR CODE	HYDRAULIC			DIELESS (# CRIMPS)	WIRE STRIP LENGTH
																	Y750, PAT Y35, Y39	Y46 PAT46	Y45		
YAG36LTC38FX	500 FLEX CLASS G,H 444.4 DLO (1100/24)	---	---	3/8 [M 10]	1.38 [35]	1.73 [44]	---	.41 [10]	3.27 [83]	.53 [13]	1.19 [31]	.27 [7]	.42 [11]	20 OR 299	BROWN	U34RT (2)	U34RT (2)	U34RT (2)	HYDRAULIC: Y644 (1) Y81KFT(1) Y4PC834 (1) PAT644 (1) PAT81KFT (1)	1-3/8"	
YAG36LTC38FX45							2		2.51 [64]												3.23 [82]
YAG36LTC38FX90							3		2.73 [69]												1.80 [46]
YAG36LTC12FX							5/8 [M 16]	1	---	3.34 [85]											
YAG36LTC12FX45								2	2.51 [64]	3.30 [84]											
YAG36LTC12FX90								3	2.73 [69]	1.86 [47]											
YAG36LTC58FX				5/8 [M 16]	1	---	3.59 [91]	.66 [17]	.67 [17]												
YAG36LTC58FX45					2	2.51 [64]	3.55 [90]														
YAG36LTC58FX90					3	2.73 [69]	2.11 [53]														

SEE SHEET 1 OF 19 FOR NOTES

TO ORDER BURNDY® PRODUCTS CALL		HYLUG™	
UNITED STATES 1-800-346-4175 (LONDONDERRY, NH)		ITEM NO:	
CANADA: 1-800-361-6975 (QUEBEC) 1-800-387-6487 (ALL OTHER PROVINCES)		CAT. NO: YAG36LTC-FX (TABLE)	
FOR PRODUCT INFO: <a href="http://www.burndy.com">http://www.burndy.com</a>		DRAWN BY: M. RAMESH 3/29/2012	
		CHECKER: R. ROMAN 4/28/2012	
		DSN APRVL: R. ROMAN 4/27/2012	
		MFG APRVL: T. WATTS 4/27/2012	
		QA APRVL: J. SYLVIA 4/30/2012	
		MKT APRVL:	
		PROD FAM:	
		PROJECT #: CM&R	
		SIZE: C	
		DRAWING NO: 50000268	
		DOCUMENT TYPE: SALES	
		SHEET 15 OF 19	
		REV: D	

CATALOG NO.	CONDUCTOR			BOLT SIZE	FIG NO.	DIMENSIONS										HYLUG® INSTALLATION TOOLING (# CRIMPS)						
	FLEX	CODE (AWG)	NAVY			B	C	H	K	L	N	O.D.	T REF.	Z MIN.	DIE INDEX	COLOR CODE	HYDRAULIC			DIELESS (# CRIMPS)	WIRE STRIP LENGTH	
																	Y750, PAT750 Y35, Y39	Y46 PAT46	Y45			
YAG38LTC516FX	550 FLEX CLASS G,H,I 535 DLO 1325/24)	---	---	5/16 [M 8]	145 [37]	184 [47]	---	.33 [8]	3.08 [78]	.34 [9]	1.25 [32]	.27 [7]	L99	PINK	U38XRT (2)	U38XRT (2)	U38XRT (2)	HYDRAULIC: Y644 (1) Y81KFT(1) Y4PC834 (1) PAT644 (1) PAT81KFT (1)	1-7/16"			
YAG38LTC516FX45							2.64 [67]		3.01 [76]											.36 [9]		
YAG38LTC516FX90							2.85 [72]		1.52 [39]													
YAG38LTC38FX							---		3.39 [86]													
YAG38LTC38FX45							2.64 [67]		.40 [10]											3.32 [84]	.50 [13]	.52 [13]
YAG38LTC38FX90							2.85 [72]		1.83 [46]													
YAG38LTC12FX				1/2 [M 12]	1	---	3.46 [88]	.53 [13]	1.25 [32]	.27 [7]	L99	PINK	U38XRT (2)	U38XRT (2)	U38XRT (2)							
YAG38LTC12FX45					2	2.64 [67]	3.38 [86]									.53 [13]	.55 [14]					
YAG38LTC12FX90					3	2.85 [72]	1.90 [48]															
YAG38LTC58FX				5/8 [M 16]	1	---	3.71 [94]	.69 [17]	1.25 [32]	.27 [7]	L99	PINK	U38XRT (2)	U38XRT (2)	U38XRT (2)							
YAG38LTC58FX45					2	2.64 [67]	3.63 [92]									.66 [17]	.67 [17]					
YAG38LTC58FX90					3	2.85 [72]	2.15 [55]															

SEE SHEET 1 OF 19 FOR NOTES

TO ORDER BURNDY® PRODUCTS CALL		HYLUG™	
UNITED STATES 1-800-346-4175 (LONDONDERRY, NH)		ITEM NO:	
CANADA: 1-800-361-6975 (QUEBEC) 1-800-387-6487 (ALL OTHER PROVINCES)		CAT. NO: YAG38LTC--FX (TABLE)	
FOR PRODUCT INFO: <a href="http://www.burndy.com">http://www.burndy.com</a>		DRAWN BY: M. RAMESH 3/29/2012 CHECKER: R. ROMAN 4/28/2012 DSN APRVL: R. ROMAN 4/27/2012 MFG APRVL: T. WATTS 4/27/2012 QA APRVL: J. SYLVIA 4/30/2012	
MKT APRVL:			
PROD FAM:	DRAWING NO:	SIZE:	REV:
PROJECT #:	50000268	C	D
DOCUMENT TYPE: SALES	SHEET 16 OF 19		
REL LEVEL: Released			



CATALOG NO.	CONDUCTOR			BOLT SIZE	FIG NO.	DIMENSIONS								INSTALLATION TOOLING (# CRIMPS)							
	FLEX	CODE (AWG)	NAVY			B	C	H	K	L	N	O.D.	T REF	Z MIN.	DIE INDEX	COLOR CODE	HYDRAULIC			DIELESS (# CRIMPS)	WIRE STRIP LENGTH
																	Y750, PAT750 Y35 Y39	Y46 PAT46	Y45		
YAG40LTC516FX	650 FLEX CLASS G 646 DLO (1600/24)	---	---	5/16 [M 8]	1.42 [36]	1.96 [50]	---	.33 [8]	3.11 [79]	.34 [9]	1.35 [34]	.30 [8]	24	BLACK	U39RT (2)	U39RT (2)	U39RT (2)	HYDRAULIC: Y644 (1) Y81KFT(2) Y4PC834 (2) PAT644 (1) PAT81KFT (2)	1-7/16"		
YAG40LTC516FX45							2		2.74 [70]											3.10 [79]	.36 [9]
YAG40LTC516FX90							3		2.94 [75]											1.59 [40]	
YAG40LTC38FX				3/8 [M 10]			1	---	3.42 [87]	.50 [13]											
YAG40LTC38FX45							2	2.74 [70]	3.42 [87]												
YAG40LTC38FX90							3	2.94 [75]	1.91 [49]												
YAG40LTC12FX				1/2 [M 12]			1	---	3.48 [88]	.53 [13]											
YAG40LTC12FX45							2	2.74 [70]	3.47 [88]												
YAG40LTC12FX90							3	2.94 [75]	1.96 [50]												
YAG40LTC58FX				5/8 [M 16]			1	---	3.73 [95]	.66 [17]											
YAG40LTC58FX45							2	2.74 [70]	3.72 [94]												
YAG40LTC58FX90							3	2.94 [75]	2.21 [56]												

SEE SHEET 1 OF 19 FOR NOTES

TO ORDER BURNDY® PRODUCTS CALL		HYLUG™	
UNITED STATES 1-800-346-4175 (LONDONDERRY, NH)		ITEM NO:	
CANADA: 1-800-361-6975 (QUEBEC) 1-800-387-6487 (ALL OTHER PROVINCES)		CAT. NO: YAG40LTC--FX (TABLE)	
FOR PRODUCT INFO: <a href="http://www.burndy.com">http://www.burndy.com</a>		DRAWN BY: M.RAMESH 3/29/2012 CHECKER: R.ROMAN 4/28/2012 DSN APRVL: R.ROMAN 4/27/2012 MFG APRVL: T.WATTS 4/27/2012 QA APRVL: J.SYLVIA 4/30/2012	
PROJ FAMIL:		DRAWING NO	
PROJECT #: CM&R		50000268	
DOCUMENT TYPE: SALES		REV	
REL LEVEL: Released		D	

REV	DATE	DESCRIPTION	ECO	BY	CHK.
D	03/29/2016	CATALOG NUMBERS UPDATED IN SHEET-14	43089	CV	MB

CATALOG NO.	CONDUCTOR			BOLT SIZE	FIG NO.	DIMENSIONS								BURNDY® INSTALLATION TOOLIG (# CRIMPS)					DIELESS (# CRIMPS)	WIRE STRIP LENGTH		
	FLEX	CODE (AWG)	NAVY			B	C	H	K	L	N	O.D.	T REF	Z MIN.	DIE INDEX	COLOR CODE	HYDRAULIC					
																	Y750HS PAT750 Y39	Y46 PAT46			Y45	
YAG44LTC12FX	750 FLEX CLASS G,H 77 DLO (1923/24)	---	---	1/2 [M12]	1	1.65 [42]	2.18 [55]	---	3.85 [98]	.53 [13]	3.81 [97]	.53 [13]	1.50 [38]	.33 [8]	L115	YELLOW	U44XRT (2)	U44XRT (2)	U44XRT (2)	HYDRAULIC: Y644 (1) Y81KFT (2) Y4PC834 (2) PAT644 (1) PAT81KFT (2)	1-5/8"	
YAG44LTC12FX45					2			3.11 [79]	4.10 [104]													66 [17]
YAG44LTC12FX90					3			3.35 [85]	4.06 [103]													2.32 [59]
YAG44LTC58FX				5/8 [M16]	1	---	4.10 [104]	.66 [17]														
YAG44LTC58FX45					2	3.11 [79]	69 [17]		4.06 [103]													
YAG44LTC58FX90					3	3.35 [85]	2.32 [59]															

SEE SHEET 1 OF 19 FOR NOTES

TO ORDER BURNDY® PRODUCTS CALL		HYLUG™	
UNITED STATES 1-800-346-4175 (LONDONDERRY, NH)		ITEM NO:	
CANADA: 1-800-361-6975 (QUEBEC) 1-800-387-6487 (ALL OTHER PROVINCES)		CAT. NO: YAG44LTC--FX (TABLE)	
FOR PRODUCT INFO: <a href="http://www.burndy.com">http://www.burndy.com</a>		DRAWN BY: M. RAMESH 3/29/2012	
		CHECKER: R. ROMAN 4/28/2012	
		DSN APRVL: R. ROMAN 4/27/2012	
		MFG APRVL: T. WATTS 4/27/2012	
		QA APRVL: J. SYLVIA 4/30/2012	
		MKT APRVL:	
		PROD FAM:	
		PROJECT #: CM&R	
		DOCUMENT TYPE: SALES	
		REL LEVEL: Released	
		SIZE	DRAWING NO
		C	50000268
			REV
			D
		SHEET 18 OF 19	



CATALOG NO.	CONDUCTOR		BOLT SIZE	FIG NO.	DIMENSIONS								BURNDY® INSTALLATION TOOLING (# CRIMPS)										
	FLEX	CODE (AWG)			B	C	H	K	L	N	O.D.	T REF.	Z MIN.	DIE INDEX	COLOR CODE	MECHANICAL		HYDRAULIC				DIELESS (# CRIMPS)	WIRE STRIP LENGTH
																MD6	PAT600 Y500CTHS	Y750HS, Y35, Y39, PAT750	Y46 <4> PAT46	Y45 <3>			
YAG29LTC14FX	4/0 FLEX CLASS G,H,I,K,M DLO (550/24)	250	1/4 [M6]	1	1.03 [26]	1.18 [30]	---	2.27 [58]	.31 [8]	.80 [21]	.16 [4]	16	YELLOW	W29RT (2) W29VT (2) X29RT (4)	W29RT (2) W29VT (2) X29RT (4)	U29RT (1)	U29RT (1)	U29RT (1)	HYDRAULIC: PAT644(1) Y644(1) PAT81KFT(1) Y81KFT(1) Y4PC34(1)	1-1/16"			
2				1.75 [44]			.27 [7]	2.17 [55]													.32 [8]		
3				1.91 [49]				1.17 [30]															
YAG29LTC14FX45			3/8 [M10]	1	---	2.45 [62]	.41 [10]	.42 [11]															
2				1.75 [44]	.40 [10]	2.35 [60]																	
3				1.91 [49]		1.35 [34]																	
YAG29LTC14FX90			1/2 [M12]	1	---	2.70 [69]	.53 [13]	.55 [14]															
2				1.75 [44]	.53 [13]	2.61 [66]																	
3				1.91 [49]		1.60 [41]																	
YAG29LTC38FX			5/8 [M16]	1	---	2.95 [75]	.69 [17]	.66 [17]															
2				1.75 [44]	.69 [17]	2.86 [73]																	
3				1.91 [49]		1.85 [47]																	
YAG29LTC38FX45			5/16 [M8]	1	---	2.33 [59]	.33 [8]	.34 [9]															
2				1.75 [44]	.33 [8]	2.24 [57]																	
3				1.91 [49]		1.23 [31]																	
YAG29LTC38FX90			3/4 [M20]	1	---	3.14 [80]	.81 [21]	.75 [19]															
2				1.75 [44]	.81 [21]	3.05 [77]																	
3				1.91 [49]		2.04 [52]																	

SEE SHEET 1 OF 19 FOR NOTES

TO ORDER BURNDY® PRODUCTS CALL		HYLUG™	
UNITED STATES 1-800-346-4175 (LONDONDERRY, NH)		ITEM NO:	
CANADA: 1-800-361-6975 (QUEBEC) 1-800-387-6487 (ALL OTHER PROVINCES)		CAT. NO: YAG29L--TC--FX (TABLE)	
FOR PRODUCT INFO: <a href="http://www.burndy.com">http://www.burndy.com</a>		DRAWN BY: M. RAMESH 3/29/2012 CHECKER: R. ROMAN 4/25/2012 DSN APRVL: R. ROMAN 4/27/2012 MFG APRVL: T. WATTS 4/27/2012 QA APRVL: J. SYLVIA 4/30/2012	
PROJ FAM:		DRAWING NO	
PROJECT #: CM&R		50000268	
DOCUMENT TYPE: SALES		REV	
REL LEVEL: Released		C	
		D	